



# User's Guide

32 Watt Temperature Control Module  
TCM-39034



ILX Lightwave Corporation · 31950 Frontage Road · Bozeman, MT, U.S.A. 59715 · U.S. & Canada: [1-800-459-9459](tel:1-800-459-9459) · International Inquiries: 406-556-2481 · Fax 406-586-9405

[ilx.custhelp.com](http://ilx.custhelp.com) · [www.ilxlightwave.com](http://www.ilxlightwave.com)





# TABLE OF CONTENTS



Safety Information and the Manual ..... iii  
 General Safety Considerations ..... iii  
 Safety Marking Symbols ..... iv  
 Comments, Suggestions, and Problems .....vii

## Chapter 1 Introduction and Specifications

Product Overview ..... 1  
 Specifications<sup>1</sup> ..... 2  
 Installation ..... 4

## Chapter 2 Operation

SENSOR SELECT Switches ..... 6  
 TEC Connector ..... 7  
 TEC Grounding Considerations ..... 8  
 TEC Interlock ..... 8  
 Booster Operation ..... 8

## Chapter 3 Calibration

Recommended Equipment ..... 11  
 Environmental Conditions ..... 12  
     Warm Up ..... 12  
 TEC Calibration Procedures ..... 12  
     Local Operation Thermistor Calibration ..... 12

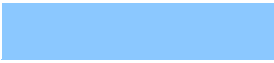

## TABLE OF CONTENTS

Remote Operation Thermistor Calibration .....	13
Local Operation AD590 Sensor Calibration .....	14
Remote Operation AD590 Sensor Calibration .....	14
Local Operation LM335 Sensor .....	15
Remote Operation LM335 Sensor .....	16
Local Operation ITE Current Calibration .....	17
Remote Operation ITE Current Calibration .....	18
Remote Operation TEC Voltage Calibration .....	20

# SAFETY AND WARRANTY INFORMATION

The Safety and Warranty Information section provides details about cautionary symbols used in the manual, safety markings used on the instrument, and information about the Warranty including Customer Service contact information.

## Safety Information and the Manual

Throughout this manual, you will see the words *Caution* and *Warning* indicating potentially dangerous or hazardous situations which, if not avoided, could result in death, serious or minor injury, or damage to the product. Specifically:

### CAUTION

Caution indicates a potentially hazardous situation which can result in minor or moderate injury or damage to the product or equipment.

### WARNING

Warning indicates a potentially dangerous situation which can result in serious injury or death.

### WARNING

Visible and/or invisible laser radiation. Avoid direct exposure to the beam.

## General Safety Considerations

If any of the following conditions exist, or are even suspected, do not use the instrument until safe operation can be verified by trained service personnel:

- Visible damage
- Severe transport stress
- Prolonged storage under adverse conditions
- Failure to perform intended measurements or functions

If necessary, return the instrument to ILX Lightwave, or authorized local ILX Lightwave distributor, for service or repair to ensure that safety features are maintained (see the contact information on page vii).

All instruments returned to ILX Lightwave are required to have a Return Authorization Number assigned by an official representative of ILX Lightwave Corporation. See Returning an Instrument on page v for more information.

# SAFETY SYMBOLS











This section describes the safety symbols and classifications.

Technical specifications including electrical ratings and weight are included within the manual. See the Table of Contents to locate the specifications and other product information. The following classifications are standard across all ILX Lightwave products:

- Indoor use only
- Ordinary Protection: This product is NOT protected against the harmful ingress of moisture.
- Class I Equipment (grounded type)
- Mains supply voltage fluctuations are not to exceed  $\pm 10\%$  of the nominal supply voltage.
- Pollution Degree II
- Installation (overvoltage) Category II for transient overvoltages
- Maximum Relative Humidity:  $< 80\%$  RH, non-condensing
- Operating temperature range of  $0\text{ }^{\circ}\text{C}$  to  $40\text{ }^{\circ}\text{C}$
- Storage and transportation temperature of  $-40\text{ }^{\circ}\text{C}$  to  $70\text{ }^{\circ}\text{C}$
- Maximum altitude: 3000 m (9843 ft.)
- This equipment is suitable for continuous operation.

## Safety Marking Symbols

This section provides a description of the safety marking symbols that appear on the instrument. These symbols provide information about potentially dangerous situations which can result in death, injury, or damage to the instrument and other components.

	Caution, refer to manual		Earth ground Terminal		Alternating current		Visible and/or invisible laser radiation
	Caution, risk of electric shock		Protective Conductor Terminal		Caution, hot surface		Frame or chassis Terminal
	On: In position of a bistable push control. The slash (I) only denotes that mains are on.				Off: Out position of a bistable push control. The circle (O) only denotes that mains are off.		
or (I)				or (O)			

# WARRANTY

ILX LIGHTWAVE CORPORATION warrants this instrument to be free from defects in material and workmanship for a period of one year from date of shipment. During the warranty period, ILX will repair or replace the unit, at our option, without charge.

## Limitations

This warranty does not apply to fuses, lamps, defects caused by abuse, modifications, or to use of the product for which it was not intended.

This warranty is in lieu of all other warranties, expressed or implied, including any implied warranty of merchantability or fitness for any particular purpose. ILX Lightwave Corporation shall not be liable for any incidental, special, or consequential damages.

If a problem occurs, please contact ILX Lightwave Corporation with the instrument's serial number, and thoroughly describe the nature of the problem.

## Returning an Instrument

If an instrument is to be shipped to ILX Lightwave for repair or service, be sure to:

- 1 Obtain a Return Authorization number (RA) from ILX Customer Service.
- 2 Attach a tag to the instrument identifying the owner and indicating the required service or repair. Include the instrument serial number from the rear panel of the instrument.
- 3 Attach the anti-static protective caps that were shipped with the instrument and place the instrument in a protective anti-static bag.
- 4 Place the instrument in the original packing container with at least 3 inches (7.5 cm) of compressible packaging material. **Shipping damage is not covered by this warranty.**
- 5 Secure the packing box with fiber reinforced strapping tape or metal bands.
- 6 Send the instrument, transportation pre-paid, to ILX Lightwave. Clearly write the return authorization number on the outside of the box and on the shipping paperwork. ILX Lightwave recommends you insure the shipment.

If the original shipping container is not available, place your instrument in a container with at least 3 inches (7.5 cm) of compressible packaging material on all sides.

Repairs are made and the instrument returned transportation pre-paid. Repairs are warranted for the remainder of the original warranty or for 90 days, whichever is greater.

### **Claims for Shipping Damage**

When you receive the instrument, inspect it immediately for any damage or shortages on the packing list. If the instrument is damaged, file a claim with the carrier. The factory will supply you with a quotation for estimated costs of repair. You must negotiate and settle with the carrier for the amount of damage.





### Comments, Suggestions, and Problems

To ensure that you get the most out of your ILX Lightwave product, we ask that you direct any product operation or service related questions or comments to ILX Lightwave Customer Support. You may contact us in whatever way is most convenient:

Phone ..... (800) 459-9459 or (406) 586-1244

Fax ..... (406) 586-9405

On the web at: ..... ilx.custhelp.com

Or mail to:

ILX Lightwave Corporation  
P. O. Box 6310  
Bozeman, Montana, U.S.A 59771  
www.ilxlightwave.com

When you contact us, please have the following information:

Model Number: \_\_\_\_\_

Serial Number: \_\_\_\_\_

End-user Name: \_\_\_\_\_

Company: \_\_\_\_\_

Phone: \_\_\_\_\_

Fax: \_\_\_\_\_

Description of what is connected to the ILX Lightwave instrument:  
\_\_\_\_\_

Description of the problem:  
\_\_\_\_\_

If ILX Lightwave determines that a return to the factory is necessary, you are issued a Return Authorization (RA) number. Please mark this number on the outside of the shipping box.

You or your shipping service are responsible for any shipping damage when returning the instrument to ILX Lightwave; ILX recommends you insure the shipment. If the original shipping container is not available, place your instrument

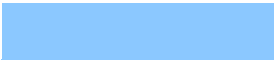

## WARRANTY

in a container with at least 3 inches (7.5 cm) of compressible packaging material on all sides.

We look forward to serving you even better in the future!

# INTRODUCTION AND SPECIFICATIONS

---

## Product Overview

The TCM-39034 32 Watt Temperature Control Module is a precision TEC control module for use in the LDC-3900 Modular Laser Diode Controller. It may be installed in any of the four channel slots on the rear of the LDC-3900 and may readily be interchanged with any other LDC-3900 module.

**Note:** Version 3.5 or newer firmware is required in the LDC-3900 mainframe in order to use the TCM-39034.

Features of the TCM-39034 include:

- Service free modularity (calibration information is stored on the TCM-39034)
- Closed case calibration
- Operational with most thermistors, and IC temperature sensor (RTD requires Model 599 adapter)
- Flexible setup with LDC-3900 Save / Recall front panel functions
- High temperature stability; better than 0.01 °C over 24 hours
- TEC voltage measurement (via remote operation)

Specifications<sup>1</sup>

Temperature Control	
Temperature Control Range <sup>2</sup>	-99.9°C to 199.9°C
Thermistor Setpoint	
Resolution (-20°C to 20°C)	0.1°C
Accuracy (-20°C to 20°C) <sup>3</sup>	±0.2°C
Resolution (20°C to 50°C)	0.2°C
Accuracy (20°C to 50°C) <sup>3</sup>	±0.2°C
AD590 and LM335 Setpoint <sup>4</sup>	
Resolution (-20°C to 50°C)	0.1°C
Accuracy (-20°C to 50°C) <sup>3</sup>	±0.2°C
Short Term Stability (1 hour) <sup>5</sup>	<±0.004°C
Long Term Stability (24 hours) <sup>6</sup>	<±0.01°C
TEC Output <sup>7</sup>	
Output Type	Bipolar constant current source
Isolation	Isolated from other modules and earth ground
Compliance Voltage	> 8 V
Maximum Current Output	4 A
Maximum Output Power	32 W
Current Limit Range	0 - 4 A
Current Limit Set Accuracy	±50 mA
Ripple / Noise <sup>8</sup>	< 1 mA rms
Control Algorithm	Smart Integrator, Hybrid PI
Temperature Sensor	
Types	
Thermistor	NTC (2-wire)
IC Temperature Sensor	AD590/LM335
RTD Sensor <sup>9</sup>	Pt100/other 100Ω RTD
Thermistor Sensing Current	10/100 μA
Sensor Bias	AD590 - 8V, LM336 - 1mA, RTD - 0.8 mA <sup>9</sup>
Usable Thermistor Range	25-450,000Ω, typical
Typical Sensor Output <sup>10</sup>	
AD590 Current Output	I (25°C) = 298.2 μA, I <sub>t</sub> = 1 μA/K
LM335 Voltage Output	V (25°C) - 2.73V, V <sub>t</sub> = 10 mV/K

RTD (PT100) Resistance	R (25°C) = 109.73Ω
User Calibration	Thermistor = Steinhart-Hart, IC Sensors, RTD = Two-point
<b>TEC Output Connectors</b>	
Temperature Controller Output	15-pin, D-sub
<b>TEC Measurement (Display)<sup>11</sup></b>	
Temperature	
Range (10μA Setting) <sup>12,13</sup>	-99.99°C to 199.99°C
Resolution (10μA Setting)	0.01°C
Accuracy (10μA Setting)	±0.1°C
Range (100μA Setting) <sup>12,14</sup>	-99.99°C to 199.99°C
Resolution (100μA Setting)	0.01°C
Accuracy (100μA Setting)	±0.05°C
Thermistor Resistance	
Range (10μA Setting)	0.0 - 480.00 kΩ
Resolution (10μA Setting)	0.01 kΩ
Accuracy (10μA Setting)	±0.05 kΩ
Range (100μA Setting)	0.0 - 480.00 kΩ
Resolution (100μA Setting)	0.001 kΩ
Accuracy (100μA Setting)	±0.005 kΩ
TE Current	
Range	-4.000 to 4.000A
Resolution	0.001A
Accuracy	±0.04A
<b>TE Voltage<sup>15</sup></b>	
Voltage Range	-9.999 to 9.999V
Voltage Resolution	1 mV
Voltage Accuracy	±30 mV <sup>16</sup>

1 All values relate to a one-hour warm-up period.

2 Software limits of range. Actual range possible depends on the physical load, thermistor type, and TE module used.

3 Accuracy figures are quoted for a typical 10kW thermistor and 100μA current setting. Accuracy figures are relative to the calibration standard. Both resolution and accuracy are dependent upon the user-defined configuration of the instrument.

4 Accuracy depends upon the sensor model selected, the calibration standard, and the user-defined configuration of the instrument.

5 Over any one-hour period, half-scale output, controlling an LDM-4412 mount at 25°C, with 10kW thermistor on 100μA setting.

6 Over any 24-hour period, half-scale output, controlling an LDM-4412 mount at 25°C, with 10kW thermistor on 100μA setting.

7 Into a 1W load.

8 Measured at 1A output over a bandwidth of 10Hz to 10MHz.

9 To use RTD sensors with model 39034, order TSC-599 Temperature Sensor Converter accessory.

10 Nominal temperature coefficients,  $I_t$  and  $V_t$ , apply over the rated IC temperature sensor range.

11 Displayed on LDC-3900 mainframe front panel "TEC" section.

12 Software limits of display range.

13 Using a 100kW thermistor, controlling an LDM-4412 mount over -30°C to 25°C.

## Installation

This section describes the procedures for installing and removing a TCM-39034 module from the LDC-3900.

**Note:** The LDC-3900 will power up in a default state upon detecting any change in the LDC-3900 system configuration (such as installing a new module). All parameters (except SAVE / RECALL settings) will be set to default values, based on the new configuration. Calibration data is stored in the TCM-39034 module itself, and is never lost due to reconfiguration of the LDC-3900. The LDC-3900 mainframe must have Version 3.5 or newer firmware to support the TCM-39034.

To install the TCM-39034 module into the LDC-3900, follow these steps:

- 1 Turn the LDC-3900 power OFF.
- 2 Place the TCM-39034 module into an open bay on the back of the LDC-3900 and slide the module into place. There are tracks at the top and bottom of the bay which guide the module into place. Push the module into place until the board edge clicks into place with an audible “pop”. This indicates that the module is “locked” into place. Screw the Module Locking Screws into the back panel to secure the module. It is then ready to be used in the LDC-3900.
- 3 Power up the LDC-3900
- 4 After the LDC-3900 has completed its power up sequence, the ( ADJUST ) LAS indicator which corresponds to the newly installed TCM-39034 module should be lit in green, indicating that the module has been recognized as a LASER current source in its respective bay.

To remove the TCM-39034 module from the LDC-3900, follow these steps:

- 1 Turn the LDC-3900 power OFF.
- 2 Unscrew the Module Locking Screws which secure the module to the LDC-3900 back panel.
- 3 Grasp the TCM-39034 module by the handle which extends from the bottom of the back panel. Gently, but firmly, pull the module out of the LDC-3900.
- 4 If the TCM-39034 module is replaced in the LDC-3900 before the LDC-3900 is powered up again, the LDC-3900 will retain its memory of all parameter settings and SAVE / RECALL values. However, if the LDC-3900 is powered up and detects a change in its system configuration, all parameters and SAVE / RECALL information will be lost. Calibration data is stored in the TCM-39034 module itself, and is never lost due to reconfiguration of the LDC-3900.

**OPERATION**

This section describes the procedures for connecting and running a temperature controlled laser diode with the TCM-39034 module. Refer to Chapter 2 of the LDC-3900 manual for front panel description and operation.

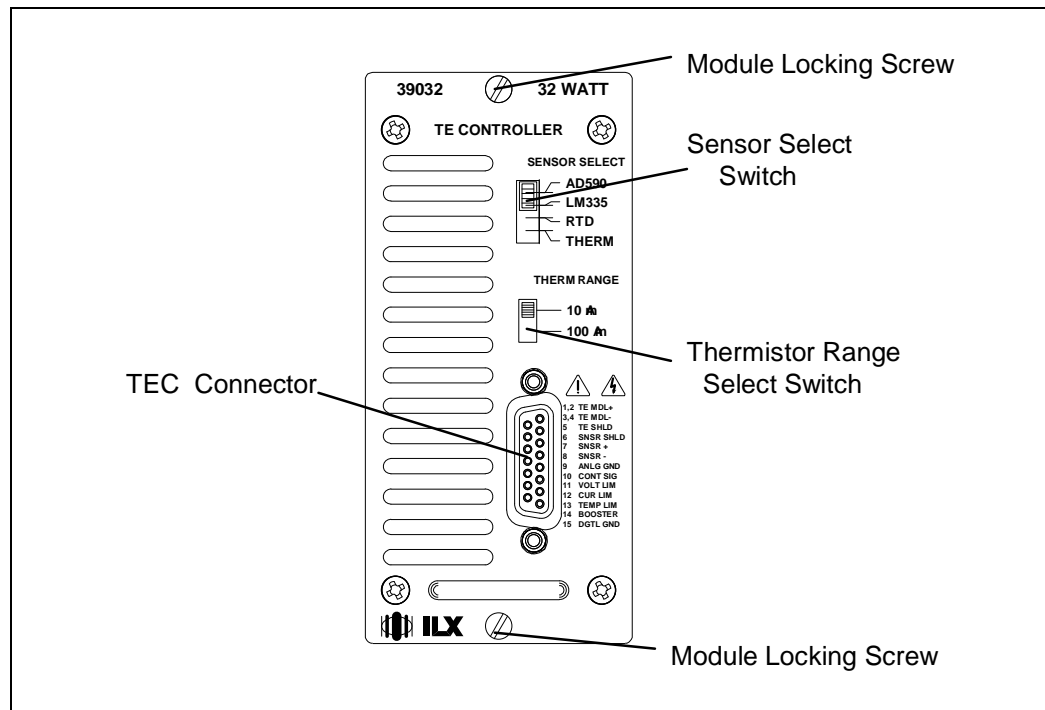

Figure 2.1 TCM-39034 Back Panel

## SENSOR SELECT Switches

The SENSOR SELECT and THERM RANGE switches are used to select sensor type and, in the case of thermistor sensor, the source current level. Table 2.1 shows the SENSOR SELECT ( THERM RANGE ) positions and corresponding position code. When the sensor switch is changed during TEC mode operation, the new sensor position code will be indicated on the TEC display for three seconds.

SWITCH Position	Code
100 $\mu$ A	-- 01
10 $\mu$ A	-- 02
LM335	-- 03
AD590	-- 04
NC (not connected)	-- 05

**Table 2.1** SENSOR SELECT Switch Positions.

The 10  $\mu$ A and 100  $\mu$ A designations are for the current source level; thermistor sensor type is implied. When using a thermistor, the supply current depends on the thermistor operating temperature range and the required temperature resolution.

The AD590 sensor operates as a current source which is proportional to the sensed temperature. The LM335 sensor operates as a voltage source which is proportional to the sensed temperature. Both of these sensors are approximately linear over their operating ranges. When they are used, the constants C1 and C2 are used for a two-point conversion.



## TEC Connector

At the right of center, on the TCM-39034 back panel, the user will find the 15-pin D-connector for the TEC MODULE. This connector is used for the input and output connections, as shown by the pin-out diagram below.

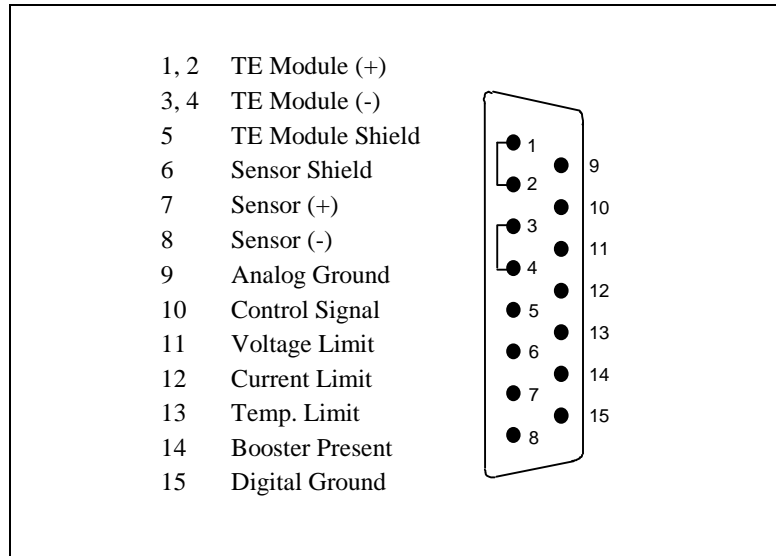

**Figure 2.2** Back Panel TEC Connector

If it is necessary to run the TCM-39034 without a TE load, the following “dummy” load is recommended.

- Connect a wire (or a resistor, depending on the current desired to run through this load) between pins 2 and 3 to serve as a dummy TE module. This wire must be capable of handling 4 Amps, if the TCM-39034 is to be run with full ITE current.
- Connect a 10 k $\Omega$  resistor between pins 7 and 8. This will serve as a sensor load.
- Set the thermistor range switch for 100  $\mu$ A.
- Set the Sensor Select switch to “THERM” and use the default settings for C1, C2 and C3. This will simulate a temperature measurement of about 25  $^{\circ}$ C. With these “dummy” loads, the TCM-39034 may be operated without any errors such as E403 “open module”, E407” temperature limit”, or E402 “sensor open”.

## TEC Grounding Considerations

DO NOT allow Sensor (-) to connect to TEC Module (-) or TEC Module (+) directly or through a common ground. Even a momentary connection when the output is off will cause damage to the instrument and/or device. For the TEC connector, if any one terminal pin is grounded, then no other terminal pin should be grounded. Instrument damage caused by shorting these pins is not covered under warranty.

## TEC Interlock

On the back panel TEC connector, pins 13 (TEMP LIMIT) and 15 (DIGITAL GND) form a type of interlock. These two pins are normally not connected (open circuit) and must remain open for the TEC output to be on. If there is a short circuit between these pins, the TEC output will be disabled. When this short circuit is present, the TEC Interlock Error condition / event will be reported in the TEC Event Status REGISTER and the TEC Condition Status Register.

This circuit is useful for remote monitoring of temperature, and therefore is labeled TEMP LIMIT on the back panel connector. This interlock is intended for use with an external current booster. A switch or control circuit of the user's own design is required. It is left as an option which the user may or may not employ.

## Booster Operation

The TCM-39034 may be used to control a booster current source which accepts a control signal of up to  $\pm 10.0$  volts. A booster current source may be required if the TCM-39034's  $\pm 4$  A, 32 W output is not adequate to control a thermal load.

Whenever a connection is present between the BOOSTER PRESENT (pin 14) and DIGITAL GROUND (pin 15) of the back panel TEC Input/Output connector, the BOOST CONTROL signal voltage will be available for controlling a booster TEC current source.

The Booster Enabled condition is reported in the TEC Condition Status register. When the GPIB option is implemented, this condition may be used to trigger a service request.

The booster current source should use the control voltage which is available between the BOOST CONTROL (pin 10) and AGND (pin 9) of the back panel TEC connector.

When the BOOSTER PRESENT signal is connected to DIGITAL GROUND, the LIM I value may be increased above the normal operation maximum of 4.0 Amps,

to a maximum of 10.0 Amps. This is permitted for operation with a booster current source so that the CONTROL SIGNAL voltage may be  $\pm 10.0$  volts. The CONTROL SIGNAL voltage is linearly proportional to the control current, which is limited by the LIM I parameter.

Whether or not a booster current source is used, the TCM-39034 uses a sensor for controlling the temperature. The feedback loop GAIN may require adjustment when a booster current source is used. This is because a booster current source may be used with different thermal loads than those found with normal TCM-39034 operation, and those loads may require larger or smaller GAIN values in order to settle to the set temperatures in a desirable fashion. See the LDC-3900 Instruction Manual for setting the GAIN value.

During operation, if the status of the connection between the BOOSTER PRESENT and DIGITAL GROUND changes, this event will be reported in the TEC Event Status Register. When the GPIB option is implemented, this event may be used to trigger a service request.



# CALIBRATION



The TCM-39034 should be calibrated every 12 months or whenever performance verification indicates that calibration is necessary.

All calibrations can be done with the case closed. The instrument is calibrated by changing the internally stored digital calibration constants.

## Recommended Equipment

Recommended test equipment for calibrating the TCM-39034 is listed in the table below. Equipment other than that shown in the table may be used if the specifications meet or exceed those listed. If the LDC-3900 is equipped with the Model 1231 GPIB/IEEE-488.2 interface, the user may refer to the calibration procedures using the GPIB later in this chapter. Please note that the TE Voltage measurement may only be calibrated via GPIB.

Description	Mfg./Model	Specification
DMM	HP 3457A	DC Amps ( @ 1.0 A ): $\pm 1\%$ Resistance ( @ 10 $\Omega$ ): 0.02%
Resistors	Metal Film	10 K $\Omega$ for 100 $\mu$ A calibration 100 K $\Omega$ for 10 $\mu$ A calibration 6.8 K $\Omega$ for LM335 sensor calibration 16.8 K $\Omega$ for AD590 sensor calibration
Resistors	High Power	1 $\Omega$ , 10 W, low TCR, resistor for current calibration 50 $\Omega$ , 5W, low TCR, resistor for voltage calibration

**Table 3.1** Recommended Test Equipment

## Environmental Conditions

Calibrate this instrument under laboratory conditions. ILX recommends calibration at  $23\text{ }^{\circ}\text{C} \pm 1.0\text{ }^{\circ}\text{C}$ . When necessary, however, the LDC-3900 Modular Laser Diode Controller may be calibrated at its intended use temperature if this is within the specified operating temperature range of 0 to  $50\text{ }^{\circ}\text{C}$ .

### Warm Up

The LDC-3900 should be allowed to warm up for at least 1 hour before calibration.

## TEC Calibration Procedures

There are four calibration procedures required for the TCM-39034, when using thermistors.

- Calibration of the resistance at the 10 microamp source current setting
- Calibration of the resistance at the 100 microamp source current setting
- Calibration of the ITE current limits
- Calibration of the TEC voltage measurement

If linear temperature sensors are used, they should be calibrated as outlined in the following sections. If the user has the optional Model 1231 GPIB/IEEE-488.2 interface, remote calibration procedures are also listed.

### Local Operation Thermistor Calibration

The following procedure is for calibrating the  $100\text{ }\mu\text{A}$  and  $10\text{ }\mu\text{A}$  constant current sources so that the thermistor resistances for these ranges will be as accurate as possible. This procedure is for local (front panel) operation.

- 1 Set the SENSOR SELECT switch (back panel) to the THERM position and set the THERM RANGE switch to the  $100\text{ }\mu\text{A}$  position. Select the TCM-39034 for calibration by pressing the appropriate (ADJUST) LAS / TEC switch (so that the TEC indicator is orange).
- 2 Measure and record the exact resistance of the metal film resistors. (A 4-point probe resistance measurement is recommended.)
- 3 Connect the correct metal film resistor to the thermistor input of the TCM-39034 (pins 7 and 8). Use nominal values of  $10\text{ K}\Omega$  for the  $100\text{ }\mu\text{A}$  setting and  $100\text{ K}\Omega$  for the  $10\text{ }\mu\text{A}$  setting.
- 4 Enter the TEC sensor calibration mode by pushing the (GPIB) LOCAL and (TEC DISPLAY) R switches at the same time. The TEC display will become blank for 2 seconds, then the sensor code (SENSOR SELECT switch position) value will be

displayed for 2 seconds. After this, the TEC display will indicate sensor resistance in  $K\Omega$ . The LDC-3900 will beep when it is ready to accept a new calibration value.

- 5 Press and hold the (PARAMETER) SET switch and turn the ADJUST knob until the TEC display indicated the same resistance recorded for the metal film resistor.
- 6 Release the (PARAMETER) SET switch to store the new value into non-volatile memory on the TCM-39034. After the (PARAMETER) SET switch is released, the LDC-3900 will beep and return to its former state (before calibration).
- 7 Switch the THERM RANGE switch (back panel) to the  $10\mu A$  position and repeat this procedure with the other resistor.

## Remote Operation Thermistor Calibration

The following procedure is for calibrating the  $100\mu A$  and  $10\mu A$  constant current sources so that the thermistor resistances for these ranges will be as accurate as possible. This procedure is for remote (GPIB) operation.

- 1 Set the SENSOR SELECT switch (bank panel) to the THERM position and set the THERM RANGE switch to the  $100\mu A$  position.
- 2 Measure and record the exact resistance of the metal film resistors. (A 4-point probe resistance measurement is recommended.)
- 3 Connect the correct metal film resistor to the TCM-39034 thermistor input (pins 7 and 8). Use nominal values of  $10K\Omega$  for the  $100\mu A$  setting and  $100K\Omega$  for the  $10\mu A$  setting.
- 4 Enter the "TEC:CHAN x" command over the GPIB to select the channel of the TCM-39034 to be calibrated, where x = the channel number.

Enter the "TEC:CAL:SENsOr" command. The TEC display will show the resistance value. The LDC-3900 will beep when it is ready to accept a new calibration value.

If this value is to be measured and entered remotely via a GPIB controlled DMM, for example, the measured value of the resistance should not be entered until the LDC-3900 is ready to receive it.

The LDC-3900 will be ready to receive the resistance value when, after a "TEC:CAL:SENsOr?" query is sent, the response from the LDC-3900 is "1".

- 5 Input the actual resistance (in  $k\Omega$ ) measured by the external DMM (as an <nrf value>) via the "TEC:R <nrf value>" command.

After the "TEC:R" value is entered, the "\*\*OPC?" query may be used to determine when the calibration sequence is done. However, the "\*\*OPC", or "\*\*WAI" command or "\*\*OPC?" query should not be issued until after the expected "TEC:R" value is entered or the system will "hang". This happens because the LDC-3900 will wait indefinitely for an input, yet not allow any input until the calibration is finished.

- 6 Once the "TEC:R" value is sent, the LDC-3900 will beep and return to its former state (before calibration). The "OPC?" query may be used (after the "TEC:R" value is sent) to determine when the calibration is completed.

The operation complete flag (bit 0 of the Standard Event Status Register) may be used to

trigger a service request. This type of interrupt is enabled by setting bit 0 of the Service Request Enable Register (via the \*ESE command) and bit 5 of the Service Request Enable Register (via the \*SRE command). Service request (SRQ) handling depends on the GPIB hardware. Refer to the GPIB manual for details.

- 7 Switch the THERM RANGE switch (back panel) to the 10  $\mu$ A position and repeat this procedure with the other resistor.

## Local Operation AD590 Sensor Calibration

The following procedure is for calibrating the AD590 sensor so that the temperature measurement will be as accurate as possible. This procedure is for local (front panel) operation. The next section will cover remote calibration of the AD590 sensor.

- 1 Set the SENSOR SELECT switch (back panel) to the AD590 position (position --04). Select the TCM-39034 for calibration by pressing the appropriate (ADJUST) LAS / TEC switch (so that the TEC indicator is orange).
- 2 Connect a precision 16.8 K $\Omega$  (metal film) resistor and a precision ammeter in series at the sensor input of the TCM-39034 (pins 7 and 8).
- 3 Enter the TEC sensor calibration mode by pushing the (GPIB) LOCAL and (TEC DISPLAY) R switches at the same time. The sensor code (SENSOR SELECT switch position) value will be displayed for 2 seconds. After this, the TEC display will indicate sensor reference current in  $\mu$ A. The LDC-3900 will beep when it is ready to accept a new calibration value.
- 4 Press and hold in the (PARAMETER) SET switch and turn the ADJUST knob until the TEC display indicates the same current as shown on the precision ammeter.
- 5 Release the (PARAMETER) SET switch to store the new value into non-volatile memory on the TCM-39034. After the SET switch is released, the LDC-3900 will beep and return to its former state (before calibration).

## Remote Operation AD590 Sensor Calibration

The following procedure is for calibrating the AD590 sensor so that the temperature measurement will be as accurate as possible. This procedure is for remote (GPIB) operation.

- 1 Set the SENSOR SELECT switch (back panel) to the AD590 position (position --04).
- 2 Connect a precision 16.8 K $\Omega$  (metal film) resistor and a precision ammeter in series at the sensor input of the TCM-39034 (pins 7 and 8).
- 3 Enter the "TEC:CHAN x" command over the GPIB to select the channel of the TCM-39034 to be calibrated, where x = the channel number.

Enter the "TEC:CAL:SENsor" command over the GPIB. The TEC display will show the current value in  $\mu$ A. The LDC-3900 will beep when it is ready to accept a new calibration value.



- 4 Input the actual current (in  $\mu\text{A}$ ) measured by the external ammeter (as an <nrf value>) via the "TEC:R <nrf value>" command.

If this value is to be measured and entered remotely via a GPIB controlled DMM, for example, the measured value of the current should not be entered until the LDC-3900 is ready to receive it.

The LDC-3900 will be ready to receive the current value when, after a "TEC:CAL:SENsor?" query is sent, the response from the LDC-3900 is "1".

After the "TEC:R" value is entered, the "\*OPC?" query may be used to determine when the calibration sequence is done. However, the "\*OPC", or "\*WAI" command, or "\*OPC?" query should not be issued until after the expected "TEC:R" value is entered, or the system will "hand". This happens because the LDC-3900 will wait indefinitely for an input, yet not allow any input until the calibration is finished.

- 5 Once the "TEC:R" value is sent, the LDC-3900 will beep and return to its former state (before calibration). The "OPC?" query may be used (after the "TEC:R" value is sent) to determine when the calibration is completed.

The operation complete flag (bit 0 of the Standard Event Status Register) may be used to trigger a service request. This type of interrupt is enabled by setting bit 0 of the Service Request Enable Register (via the \*ESE command) and bit 5 of the Service Request Enable Register (via the \*SRE command). Service request (SRQ) handling depends on the GPIB hardware. Refer to the GPIB manual for details.

## Local Operation LM335 Sensor

The following procedure is for calibrating the LM335 sensor so that the temperature measurement will be as accurate as possible. This procedure is for local (front panel) operation. The next section will cover remote calibration of the LM335 sensor.

- 1 Set the SENSOR SELECT switch (back panel) to the LM335 position (position --03). Select the TCM-39034 for calibration by pressing the appropriate (ADJUST) LAS / TEC switch (so that the TEC indicator is orange).
- 2 Connect a precision 6.8 K $\Omega$  (metal film) resistor and a precision voltmeter in parallel at the sensor input of the TCM-39034 (pins 7 and 8).
- 3 Enter the TEC sensor calibration mode by pushing the (GPIB) LOCAL and (TEC DISPLAY) R switches at the same time. The sensor code (SENSOR SELECT switch position) value will be displayed for 2 seconds. After this, the TEC display will indicate sensor reference voltage in mV. The LDC-3900 will beep when it is ready to accept a new calibration value.
- 4 Press and hold in the (PARAMETER) SET switch and turn the ADJUST knob until the TEC display indicates the same voltage as shown on the precision voltmeter.
- 5 Release the (PARAMETER) SET switch to store the new value into non-volatile memory on the TCM-39034. After the SET switch is released, the LDC-3900 will beep and return to its former state (before calibration).

## Remote Operation LM335 Sensor

The following procedure is for calibrating the LM335 sensor so that the temperature measurement will be as accurate as possible. This procedure is for remote operation.

- 1 Set the SENSOR SELECT switch (back panel) to the LM335 position (position --03).
- 2 Connect a precision 6.8 K $\Omega$  (metal film) resistor and a precision voltmeter in parallel at the sensor input of the TCM-39034 (pins 7 and 8).
- 3 Enter the "TEC:CHAN x" command over the GPIB to select the channel of the TCM-39034 to be calibrated, where x = the channel number.

Enter the "TEC:CAL:SENsOr" command over the GPIB. The TEC display will show the current value in  $\mu$ A. The LDC-3900 will beep when it is ready to accept a new calibration value.

- 4 Input the actual voltage (in mV) measured by the external voltmeter (as an <nrf value>) via the "TEC:R <nrf value>" command.

If this value is to be measured and entered remotely via a GPIB controlled DMM, for example, the measured value of the current should not be entered until the LDC-3900 is ready to receive it.

The LDC-3900 will be ready to receive the voltage value when, after a "TEC:CAL:SENsOr?" query is sent, the response from the LDC-3900 is "1".

After the "TEC:R" value is entered, the "\*\*OPC?" query may be used to determine when the calibration sequence is done. However, the "\*\*OPC", or "\*\*WAI" command, or "\*\*OPC?" query should not be issued until after the expected "TEC:R" value is entered, or the system will "hand". This happens because the LDC-3900 will wait indefinitely for an input, yet not allow any input until the calibration is finished.

- 5 Once the "TEC:R" value is sent, the LDC-3900 will beep and return to its former state (before calibration). The "OPC?" query may be used (after the "TEC:R" value is sent) to determine when the calibration is completed.

The operation complete flag (bit 0 of the Standard Event Status Register) may be used to trigger a service request. This type of interrupt is enabled by setting bit 0 of the Service Request Enable Register (via the \*ESE command) and bit 5 of the Service Request Enable Register (via the \*SRE command). Service request (SRQ) handling depends on the GPIB hardware. Refer to the GPIB manual for details.

## Local Operation ITE Current Calibration

The following procedure is for calibrating the ITE constant current source for both polarities of current. This procedure calibrates the zero current set point automatically, then it automatically drives the TE current output to internally set limits of  $\pm 1$  Amp. When each of these values is reached and is stable, the user enters the actual value of the current, as measured by an external DMM. The LDC-3900 then automatically calibrates the TEC current source and limits.

This procedure is for local (front panel) operation. Remote calibration of the ITE current is covered in the next section.

- 1 With the output off, connect a 1  $\Omega$ , 10 W resistor across the TEC output terminals and use a calibrated DMM to measure the voltage across the resistor. Calculate the current in the following steps by using Ohm's Law:

$$I = E / R$$

- where E is the accurately measured voltage across the resistor, and R is the accurately measured load resistance. (A 4-point probe resistance measurement is recommended.)

- 2 Press the (GPIB) LOCAL and (TEC DISPLAY) ITE switches at the same time to place the TCM-39034 in its TEC Current Calibration mode. The TEC output must be off to enter the TEC calibration mode.

The TEC display will show a value of about zero amps as the TCM-39034 calibrates itself for a zero current level. After about 20 seconds, the LDC-3900 will beep and the TEC display will begin to change to show about 1 amp (the limit calibration value).

- 3 After the value on the TEC display is stable (has not changed by more than one digit for several seconds), the LDC-3900 is ready for the actual I value to be entered.

Press and hold in the (TEC DISPLAY) SET switch and turn the ADJUST knob until the TEC display shows the correct value, as calculated in Step 1.

- 4 Release the (TEC DISPLAY) SET switch to store the new calibration value into non-volatile memory on the TCM-39034. The LDC-3900 will then beep to indicate that it is ready for the user to enter the limit calibration value for its negative polarity output.
- 5 Repeat Steps 3 and 4 for negative polarity of the TEC output current. After the value for the negative polarity of the TEC output is entered, the TCM-39034 will automatically calibrate its current limits and set points. After a few seconds, the LDC-3900 will return to its former state (before calibration). The LDC-3900 will beep when it has finished storing all of the new calibration values.

## Remote Operation ITE Current Calibration

The following procedure is for calibrating the ITE constant current source for both polarities of current. This procedure calibrates the zero current set point automatically, then it automatically drives the TE current output to internally set limits of  $\pm 1$  Amp. When each of these values is reached and is stable, the user enters the actual value of the current, as measured by an external DMM. The LDC-3900 then automatically calibrates the TEC current source and limits.

This procedure is for remote (GPIB) operation.

- 1 With the output off, connect a 1  $\Omega$ , 10 W resistor across the TEC output terminals and use a calibrated DMM to measure the voltage across the resistor. Calculate the current in the following steps by using Ohm's Law:

$$I = E / R$$

- where E is the accurately measured voltage across the resistor, and R is the accurately measured load resistance. (A 4-point probe resistance measurement is recommended.)

- 2 Enter the "TEC:CHAN x" command over the GPIB to select the channel of the TCM-39034 to be calibrated, where x = the channel number. Enter the "TEC:OUTPUT OFF" command to force the output off.

Enter the "TEC:CAL:ITE" command over the GPIB to place the TCM-39034 in its TEC Current Calibration mode. The LDC-3900 will automatically calibrate its zero output current and beep when it is ready to continue. If the TEC output is not off, the TEC current calibration mode cannot be entered.

The TCM-39034 will first perform a zero point calibration. This takes about 20 seconds. Then it will set the output to 1 Amp, for calibration.

- 3 When the LDC-3900 is ready for the actual TEC current value to be entered, a remote query of "TEC:CAL:ITE?" will return a response of "1".

When the measured value (actual ITE) is stable and the LDC-3900 is ready to proceed, enter the value by issuing the "TEC:ITE <nrf value>" command, where the absolute value of the actual ITE measurement is the <nrf value>.

To ensure measurement stability of the actual I value when the measurement is taken as a part of an automated test, the DMM measurement should be polled in a loop. When the measured value is consistent within one digit for 5 seconds (for example), the actual I value could be considered stable.

- 4 Once the actual ITE value is entered via the "TEC:ITE" command, the new calibration value is stored into non-volatile memory on the TCM-39034. The LDC-3900 will then be ready for the User to enter the limit calibration value for its negative polarity output.
- 5 Repeat steps 3 and 4 for the negative polarity of the TEC output current (entering the absolute value of the measurement). After the value for the negative polarity of the TEC output is entered, the TCM-39034 will automatically calibrate its current limits and set points. After a few seconds, the LDC-3900 will return to its former state (before calibration). The LDC-3900 will beep when it has finished storing all of the new calibration values.

After the last "TEC:ITE" value is entered, the "\*OPC?" query may be used to determine when the calibration sequence is done. However, the \*OPC", or "\*\*WAI" command, or "\*OPC?" query should not be issued until after the last "TEC:ITE" value is entered or the system will "hang". This happens because the LDC-3900 will wait indefinitely for an input, yet not allow any input until the calibration is finished.

If the "\*OPC?" query is issued during ITE calibration, the time out period of the GPIB driver should be at least 1 minute to prevent the GPIB driver from timing out and "hanging" the system. Refer to the GPIB driver instruction manual for information on setting the GPIB driver time out period.

The operation complete flag (bit 0 of the Standard Event Status Register) may be used to trigger a service request. This type of interrupt is enabled by setting bit 0 of the Service Request Enable Register (via the \*ESE command) and bit 5 of the Service Request Enable Register (via the \*SRE command). Service request (SRQ) handling depends on your GPIB hardware. Refer to the GPIB manual for details.

## Remote Operation TEC Voltage Calibration

The following procedure is for calibrating the TEC voltage measurement. This procedure calibrates the positive and negative voltages in one procedure.

**Note:** The TEC voltage calibration may only be performed remotely.

- 1 With the output off, connect a 50  $\Omega$ , 5 W resistor across the TEC output terminals (TE module + and TE module -).
- 2 Connect a calibrated DMM across the load resistor. Enter the "TEC:ITE 0" command to set the TEC current at zero for the start of this procedure.
- 3 Enter the "TEC:CAL:V" command to place the Controller in its TEC Voltage Calibration mode. The TEC display will indicate a current of about -0.16 Amps so that the TEC voltage will be about -8.00 volts.
- 4 When the Controller is ready for the actual voltage value to be entered, a remote query of "TEC:CAL:V?" will return a response of "1". Allow a few seconds for the TEC current to stabilize.

When the measured value (display) is stable and the Controller is ready to proceed, enter the value by issuing the "TEC:V <nrf value>" command, where the actual TEC voltage on the DMM is the <nrf value>. Once the actual TEC voltage value is entered via the "TEC:V <nrf value>" command, the new calibration value is stored into non-volatile memory.

- 5 To ensure measurement stability of the actual TEC voltage value when the measurement is taken as a part of an automated test, the DMM measurement should be polled in a loop. When the measured value is consistent within one digit for 5 seconds (for example), the actual TEC voltage value could be considered stable.

If the "\*\*OPC?" query is issued during TEC voltage calibration, the time out period of the GPIB driver should be at least 1 minute to prevent the GPIB driver from timing out and "hanging" the system. Refer to the GPIB driver manual for information on setting the GPIB time out period.

- 6 The controller will drive the output current to a value of about 0.16 Amps, so that the TEC voltage will be about +8.00 volts.
- 7 Repeat Step 4. After the value for the positive polarity of the TEC voltage is entered, the Controller will automatically store the new calibration values for TEC voltage measurement.