

OPS-A150, OPS-A500, OPS-A1000

Oriel® Arc Lamp Power Supplies



User's Manual



1 GENERAL INFORMATION	5
1.2 GENERAL WARNINGS	6
1.3 ELECTRICAL HAZARDS.....	7
1.4 FIRE HAZARDS.....	7
1.5 LAMP HANDLING.....	7
1.6 LIGHT HAZARDS	7
2 INTRODUCTION.....	8
2.1 DESCRIPTION/FEATURES	8
2.2 DIMENSIONS	9
2.3 ARC LAMP COMPATIBILITY	10
3 SYSTEM SETUP.....	12
3.1 ITEMS INCLUDED WITH SYSTEM.....	12
3.2 UNPACKING	12
3.3 CHOOSING A LOCATION.....	13
3.4 POWER SUPPLY CONNECTIONS.....	14
3.4.1. Front Panel Controls/Connections	14
3.4.2. Rear Panel Controls/Connections (OPS-A150, OPS-A500 models only)	15
3.4.3 Rear Panel Controls/Connections (OPS-1000 model only).....	19
3.5 INITIAL START-UP SCREEN	24
4 QUICK START GUIDE	25
4.1 SETTING LAMP PARAMETERS	25
4.2 TURNING THE LAMP ON/OFF	25
4.3 LIGHT INTENSITY CONTROL	26
5 OPERATING MODES.....	27
5.1 POWER MODE.....	27
5.2 CURRENT MODE.....	27
5.3 INTENSITY MODE.....	27
5.3.1. Dosed Mode.....	27
6 POWER AND CURRENT OPERATION MODES	28
6.1 POWER OPERATION MODE	28
6.2 CURRENT OPERATION MODE	30
7 FIRMWARE AND MODEL INFORMATION.....	31
7.1 UPDATING THE FIRMWARE.....	32
8 INTERLOCK CABLES/CONNECTIONS TO LAMP HOUSINGS	34
8.1 CONNECTION TO A Q SERIES TYPE HOUSING	35
8.2 CONNECTION TO A RESEARCH LAMP HOUSING.....	36
8.2.2 Connecting the OPS-A250/OPS-A500 to a Research Lamp Housing	36
8.3.3 Connecting the OPS-A1000 to a Research Lamp Housing.....	36
8.3 SAFETY INTERLOCK.....	37
9 DETECTOR THERMOELECTRIC COOLING (APPLICABLE FOR LIK-LMP)	38
10 INTENSITY OPERATION MODE (LIK-LMP REQUIRED).....	40
10.1 Mounting the LIK-LMP to a Q Series or Research Lamp Housing	41
10.1 IDLE FUNCTION.....	46
11 SHUTTER CONTROLLER	47
11.1 SHUTTER STATUS.....	48
11.2 MANUAL SHUTTER MODE	48
11.3 TTL SHUTTER CONNECTION	49

11.4 TTL SIGNAL POLARITY.....	50
11.5 TIMED SHUTTER MODE	50
11.6 DOSED SHUTTER MODE	52
11.7 EXTERNAL SHUTTER CONTROL METHODS	54
12 AUDIO WARNING	55
12.1 AUDIO WARNING SETUP	56
13 MEMORY	57
14 SAVING SETTINGS.....	57
14.1 LOADING SETTINGS.....	58
15 MAINTENANCE.....	59
15.1 POWER SUPPLY CLEANING.....	59
15.2 LAMP CARE AND HANDLING.....	59
16 LAMP LIFETIME AND REPLACEMENT	60
17 DISPLAYING TOTAL LAMP HOURS	61
17.1 RESETTING TOTAL LAMP HOURS.....	61
18 OPS-A SERIES OVERVIEW	63
19 TROUBLESHOOTING.....	64
EU DECLARATION OF CONFORMITY	68
APPENDIX A: COMPUTER CONTROL.....	69
COMMAND SET	70
CONTACTING ORIEL INSTRUMENTS.....	76
REQUEST FOR ASSISTANCE / SERVICE.....	77
REPAIR SERVICE	77
NON-WARRANTY REPAIR.....	77
WARRANTY REPAIR.....	78
LOANER / DEMO MATERIAL.....	79

LIST OF FIGURES

Figure 1 Dimensional drawing of the OPS Series Power Supplies.	9
Figure 2 OPS-A Power Supply Front Panel Connections.....	14
Figure 3 OPS-A Power Supply Rear Panel Connections.	15
Figure 4 The LCD display of the OPS-A Model Power Supply.	24
Figure 5 USB Connector for Firmware Updates.	32
Figure 6 The LCD screen image displayed during firmware and LCD GUI interface updates.	33
Figure 7 The output connector on the rear panel of the OPS-A150/OPS-A500 Power Supply for interface with Oriel Lamp Housing. The 70050 (Black) and 70051 (Grey) Lamp Housing Interconnection Cables are also shown.	34
Figure 8 Labels on the OPS-A1000 Power Supply and Research Lamp Housing indicating the proper connector for each type lamp housing interconnection cable.....	35
Figure 9 The Arc Lamp Interface with Ignitor with 5 pin connector for electrical connection to a suitable power supply.	35
Figure 10 The electrical connector for interface with OPS-A Model Power Supply on an Oriel Research Lamp Housing.	36

Figure 11 The label directing which electrical connector to use for each lamp housing interconnection cable on a 450-1000 W Research Lamp Housing. 36

Figure 12 The Interlock Open and warning symbol indicator of the power supply indicates a cable is disconnected and/or the lamp housing is open. 37

Figure 13 The LIK-LMP Light Intensity Controller Kit couples to the Series Q or Research Lamp Housing chosen by the user and includes the necessary cables to connect the LIK-LMP to the OPS-A Power Supply. 38

Figure 14 Setting the TE Cooler Temperature..... 39

Figure 15 Exploded view of 71582 mounting to a Q Series Housing using the 68954 Adapter Kit..... 41

Figure 16 Exploded view of 71582 mounting to a Research Lamp Housing using the 68952 Adapter Kit.42

Figure 17 The DETECTOR INPUT and TE COOLER output ports are for direct use of the LIK-LMP with the OPS-A Power Supply..... 43

Figure 18 The 70062 (left) and 70018 (right) required for interfacing the 71582 Detector Head with OPS-A Arc Lamp Power Supply..... 43

Figure 19 Selecting Intensity Mode as the Operating Mode of the OPS-A Power Supply. 45

Figure 20 Idle Function Setup. 47

Figure 21 Shutter Status Indicator on Display. 48

Figure 22 Shutter Status Symbols. 48

Figure 23 Manual Shutter Mode (Shutter Closed). 49

Figure 24 Manual Shutter Button. 49

Figure 25 Shutter Output Connector..... 50

Figure 26 Trigger Example..... 55

Figure 27 Warning Icon..... 56

Figure 28 Audio Warning Setup..... 56

Figure 29 Saving Settings To Memory..... 57

Figure 30 Loading Saved Settings From Memory. 59

Figure 31 Arc Lamp Construction. 60

Figure 32 Displaying Lamp Hours..... 61





Figure 33 RS232 Connector 69

1 GENERAL INFORMATION

Thank you for your purchase of this OPS power supply from Oriel Instruments.

Please carefully read the following important safety precautions prior to unpacking and operating this equipment. In addition, please read the complete User's Manual for additional important notes and cautionary statements regarding the use and operation of the system.

1.1 SYMBOLS AND DEFINITIONS

	WARNING Situation has the potential to cause bodily harm or death.
	CAUTION Situation has the potential to cause damage to property or equipment.
	ELECTRICAL SHOCK HAZARD Hazard arising from dangerous voltage. Any mishandling could result in irreparable damage to the equipment, and personal injury or death.
	EUROPEAN UNION CE MARK The presence of the CE Mark on Newport Corporation equipment means that it has been designed, tested and certified as complying with all applicable European Union (CE) regulations and recommendations.
NOTE:	Additional important information the user or operator should consider.

Please read all instructions that were provided prior to operation of the system.

The safety of any system incorporating the OPS power supply is the sole responsibility of the assembler of the systems.

If the equipment is used in a manner not specified by Newport Corporation, the protection provided by the equipment may be impaired.

If there are any questions, please contact Oriel Instruments or the representative through whom the system was purchased prior to use.

1.2 GENERAL WARNINGS

- Read all warnings and operating instructions for this system prior to setup and use.
- Do not use this equipment in or near water.
- To prevent damage to the equipment, read the instructions in the equipment manual for proper input voltage.
- This equipment is grounded through the grounding conductor of the power cord.
- Route the power cord and other cables so they are not likely to be damaged.
- Disconnect power before cleaning the equipment.
- Do not use liquid or aerosol cleaners; use only a dry lint-free cloth.
- Lock out all electrical power sources before servicing the equipment.
- To avoid explosion, do not operate this equipment in an explosive atmosphere.
- Qualified service personnel should perform safety checks after any service.
- If this equipment is used in a manner not specified in this manual, the protection provided by this equipment may be impaired.
- To prevent damage to equipment when replacing fuses, locate and correct the problem that caused the fuse to blow before re-applying power.
- Do not block ventilation openings.
- Do not use or store flammable liquids near the power supply.
- Do not position this product in such a manner that would make it difficult to disconnect the power cord.
- Use only the specified replacement lamp.
- This product should only be powered as described in the manual.
- Do not remove the cover for normal usage.

1.3 ELECTRICAL HAZARDS

Make all connections to or from the power supply with the power off. There may be dangerous voltage present at the output terminals.

Tighten all lamp housing interconnect cable connections to prevent arcing.

There are no user serviceable parts inside the power supply. Do not use the power supply without its cover in place. Lethal voltages are present inside.

1.4 FIRE HAZARDS

Lamps are extremely hot during operation, and for several minutes after being shut off. Keep flammable objects away from the lamp and lamp housing.

Each compatible Newport brand lamp housing is equipped with a condenser lens. The re-focused output of this lens can cause ignition of flammable targets including but not limited to walls, certain chemicals.

Use only the line cord supplied with the power supply. A substitute line cord may not be rated for high current.

1.5 LAMP HANDLING

Read all information and warnings provided with lamp.

Never touch any lamp or the reflector's inner surface with bare fingers or other contaminants. Skin oil or other substances can burn into the lamp envelope during operation and negatively affect the lamp's performance and lifetime.

Always wear appropriate gloves and impact-resistant goggles when handling any lamp. Avoid any mechanical strain during handling. Do not operate the lamp without all housing panels in place.

Lamps become very hot after only a few minutes of operation (up to 150°C) and remain quite hot for at least 10 to 15 minutes after being turned off.

Do not run the lamp at more than 10% above its current or power rating. Lamp lifetime will decrease dramatically.

1.6 LIGHT HAZARDS

These lamps produce considerable ultraviolet and infrared radiation. Avoid excessive exposure of the eyes or skin to radiation from these lamps.

Utilize protective eyewear and gloves when operating these lamps.

2 INTRODUCTION

2.1 DESCRIPTION/FEATURES

The model OPS-A Power Supplies are designed to meet the needs of a regulated source of power or current for proper operation of DC arc light sources. The OPS models provide constant power or constant current operation of these sources of radiation, which is usually required whenever a radiometric measurement is being made or whenever highly stable light output is needed.

Features Include:

- Adjustable output with preset so that the output can be set before running the lamp.
- Large LCD display for precise monitoring of current, voltage, power, and lamp running time as well as light intensity and shutter timing characteristics when used with external light intensity controller kit and TTL shutter.
- Four horizontal and four vertical menu buttons as well as rotating knob on front panel for easy navigation of power supply features.
- LAMP and SHUTTER buttons located on front panel for manual control of lamp ignition and external shutter. Icons on the LCD display show the ignition and open/close statuses of the lamp during operation at all times.
- Safety interlock connector for safeguarding against accidental exposure to UV light when used with a Newport lamp housing.
- USB interface located on front panel for firmware updates.
- RS232 and USB interfaces located on the rear of the power supply for user preference of RS232 or USB external operation and monitoring.
- BNC connector on rear panel for sending electronic signals to open/close TTL shutter.
- BNC and D-SUB connector on rear panel for direct connection to LIK-LMP light intensity controller kit. These connectors are used to regulate/control the temperature of the TE cooled detector in the LIK-LMP and adjust current/power supplied to the lamp to ensure stable light output based on the current output of the detector. The LIK-LMP is typically used when an additional level of stability is required for the application.
- RoHS and CE compliance

2.2 DIMENSIONS

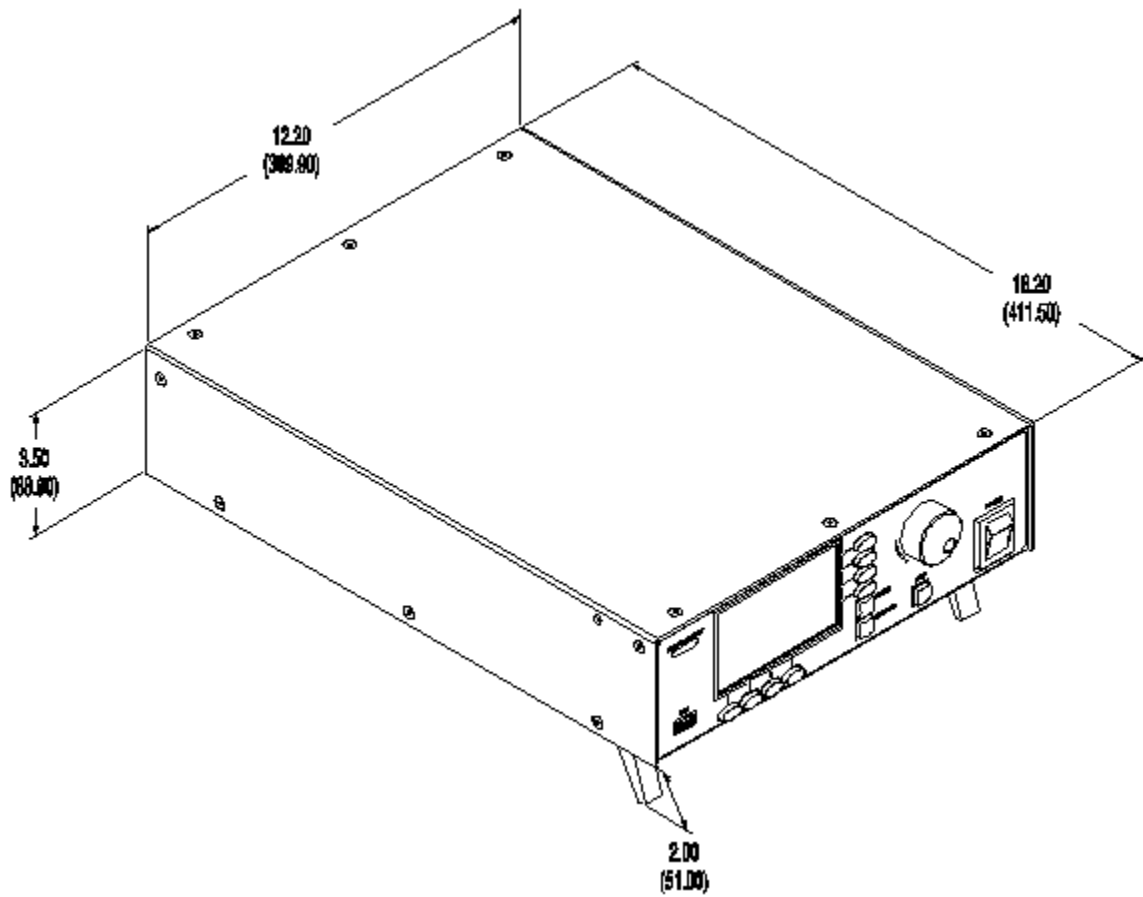

Figure 1 Dimensional drawing of the OPS Series Power Supplies.

2.3 ARC LAMP COMPATIBILITY

Newport Corporation offers all the components required to assemble a complete illumination system. The minimum components include a lamp, lamp housing, power supply, and possibly a socket adapter. The table below explains which components are compatible with each other to create an illumination system.

OPS-A150 Lamp Compatibility Table				
Power Supply	Lamp	Lamp Rating, Description	Compatible Oriel Lamp Housings	
			Q Housing [Socket Adapter]	Research Lamp Housings [Socket Adapter]
OPS-A150	6282	Hg 50 W	60000 Housing with 60025 Interface Kit [60013]	66901, 66902, 66905, 67001, 67005 [66158]
	6251NS	Xe 75 W	60000 Housing with 60025 Interface Kit [60014]	66901, 66902, 66905, 67001, 67005 [66150]
	6263	Xe 75 W (OZONE FREE)	60000 Housing with 60025 Interface Kit [60014]	66901, 66902, 66905, 67001, 67005 [66150]
	6247	Xe 75 W (HIGH STABILITY)	60000 Housing with 60025 Interface Kit [60021]	66901, 66902, 66905, 67001, 67005 [66148]
	6257	Xe 100 W (OZONE FREE)	60000 Housing with 60025 Interface Kit [60014]	66901, 66902, 66905, 67001, 67005 [66150]
	6254	Xe 150 W (UV ENHANCED)	n/a	66901, 66902, 66905, 67001, 67005 [66151]
	6255	Xe 150 W (OZONE FREE)	n/a	66901, 66902, 66905, 67001, 67005 [66151]
	6256	Xe 150 W (OZONE FREE, SMALL ARC)	n/a	66901, 66902, 66905, 67001, 67005 [66152]

OPS-A500 Lamp Compatibility Table				
Power Supply	Lamp	Lamp Rating, Description	Compatible Oriel Lamp Housings	
			Q Housing [Socket Adapter]	Research Lamp Housings [Socket Adapter]
OPS-A500	6283NS	Hg 200W	n/a	66901, 66902, 66905, 67001, 67005 [66144]
	6290	HgXe 200W (OZONE FREE)	n/a	66901, 66902, 66905, 67001, 67005 [66169]
	6259	Xe 300W (UV ENHANCED)	n/a	66901, 66902, 66905, 67001, 67005 [66160]
	6258	Xe 300W (OZONE FREE)	n/a	66901, 66902, 66905, 67001, 67005 [66160]
	6286	Hg 350W	n/a	66901, 66902, 66905, 67001, 67005 [66161]
	6285	Hg 500W	n/a	66901, 66902, 66905, 67001, 67005 [66162]
	66142	HgXe 500W	n/a	66901, 66902, 66905, 67001, 67005 [66159]

OPS-A1000 Lamp Compatibility Table				
Power Supply	Lamp	Lamp Rating, Description	Compatible Oriel Lamp Housings	
			Q Housing [Socket Adapter]	Research Lamp Housings [Socket Adapter]
OPS-A1000	6278	Xe 450W (UV ENHANCED)	n/a	66921, 66923 [6163]
	6280NS	Xe 450W (OZONE FREE)	n/a	66921, 66923 [6163]
	6285	Hg 500W	n/a	66921, 66923 [66162]
	6267	Xe 500W (OZONE FREE)	n/a	66921, 66923 [6165]
	6295NS	HgXe 1000W (OZONE FREE)	n/a	66921, 66923 [6162]
	6293	HgXe 1000W	n/a	66921, 66923 [6162]
	6269	Xe 1000W (UV ENHANCED)	n/a	66921, 66923 [6162]
	6272	Xe 1000W (OZONE FREE)	n/a	66921, 66923 [6162]

3 SYSTEM SETUP

3.1 ITEMS INCLUDED WITH SYSTEM

Oriel Instruments provides lamp interconnection cables with the lamp housing. The power supply includes the following items:

- Power Supply
- Power Cord
- User's manual

3.2 UNPACKING

Remove all items from the shipping containers and verify each item is accounted for. The system is carefully packaged to minimize the possibility of damage during shipment. Inspect the shipping boxes for external signs of damage or mishandling. Inspect the contents for damage.

If any item is missing or damaged, immediately contact Oriel Instruments or the Newport representative from whom the system was purchased. It is suggested to save the packaging material and shipping container, in case the equipment needs to be relocated at a future date.

When handling this power supply, hold it from underneath the housing. Never use any knobs, buttons or cables to carry or locate the power supply.

	<p>WARNING</p> <p>Do not attempt to operate this equipment if there is evidence of shipping damage or there is suspicion that the equipment will not operate correctly. Damaged equipment may present hazards.</p>
---	---

3.3 CHOOSING A LOCATION

Choose an installation location where the power requirements can be met for the system. Be sure power is not applied to the system until the setup has been completed.

The environment should be that of a typical laboratory atmosphere, without excessive humidity and contaminants in the air. Do not allow the ventilation holes on the power supply to be blocked. Air should be able to circulate freely around the unit.

Once the connections have been made to the back of the power supply, the unit can be operated by using the controls located on the front panel. Ensure that the final location allows for ease of access to all front panel functions.

3.4 POWER SUPPLY CONNECTIONS

3.4.1. Front Panel Controls/Connections

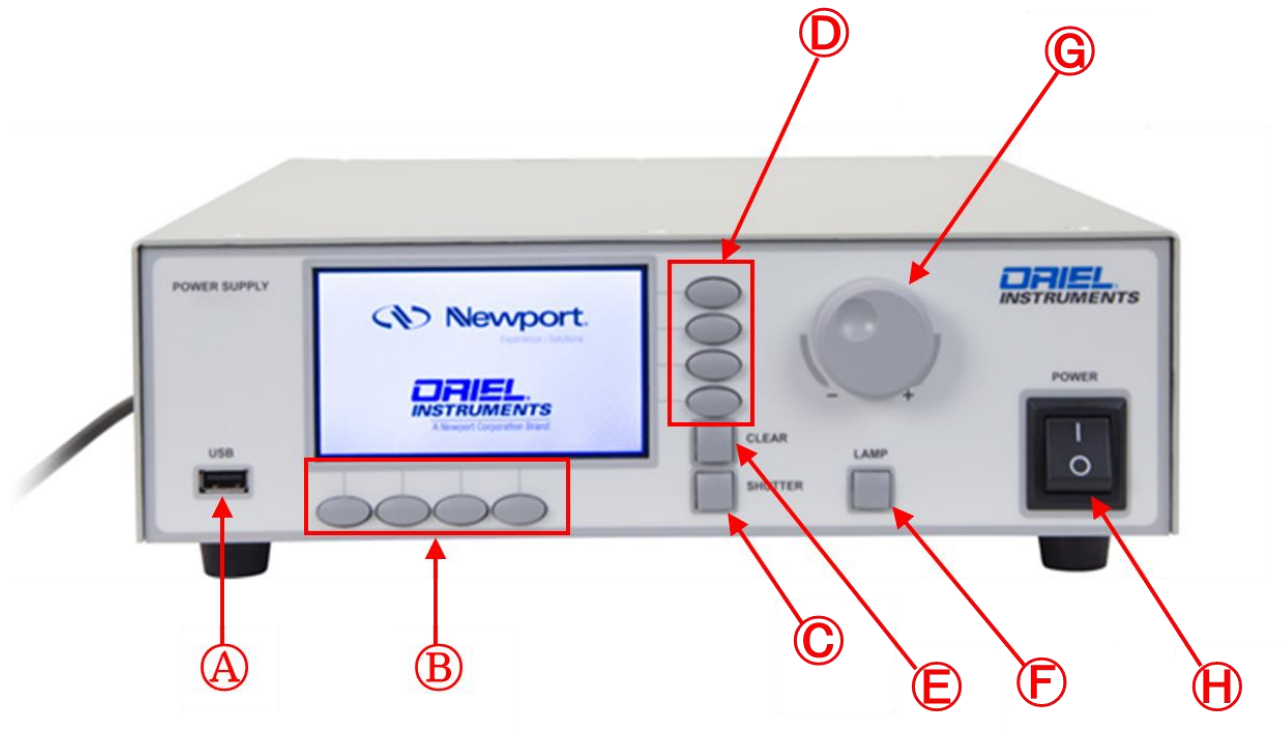

Figure 2 OPS-A Power Supply Front Panel Connections.

- A. USB.** The USB connector on the front panel is used to install firmware and LCD GUI updates to the power supply. Any firmware updates, please visit OPS-A power supply product page.
- B. Horizontal menu buttons.** These four horizontal menu buttons are for using setting and monitoring various features of the power supply:
 - a. Lamp Operating Mode
 - b. Manual/Timed Shutter Control, Display Features
 - c. Saving/loading particular setups.
- C. SHUTTER.** This button is for manual control of an electronic TTL input shutter. When pressed, the shutter will open/close.
- D. Vertical menu buttons.** These four vertical menu buttons are for navigating settings for each feature associated with pressing the horizontal menu buttons of the power supply.
- E. CLEAR.** The CLEAR button is for exiting the feature menu currently displayed on the LCD screen. This button is also used to clear any error messages that are displayed.

- F. **LAMP.** The LAMP button is for manual control of the lamp. When pressed, the lamp will ignite/power down.
- G. **Control knob.** The control knob is for setting the parameters specific to each power supply feature.
- H. **POWER.** This is the AC mains power switch. In the ON position as shown in Figure 2, AC power will be switched into the main circuitry of the power supply. There is no output from the power supply until the manual or external command to supply power to the lamp is received with the interlock condition satisfied.

3.4.2. Rear Panel Controls/Connections (OPS-A150, OPS-A500 models only)

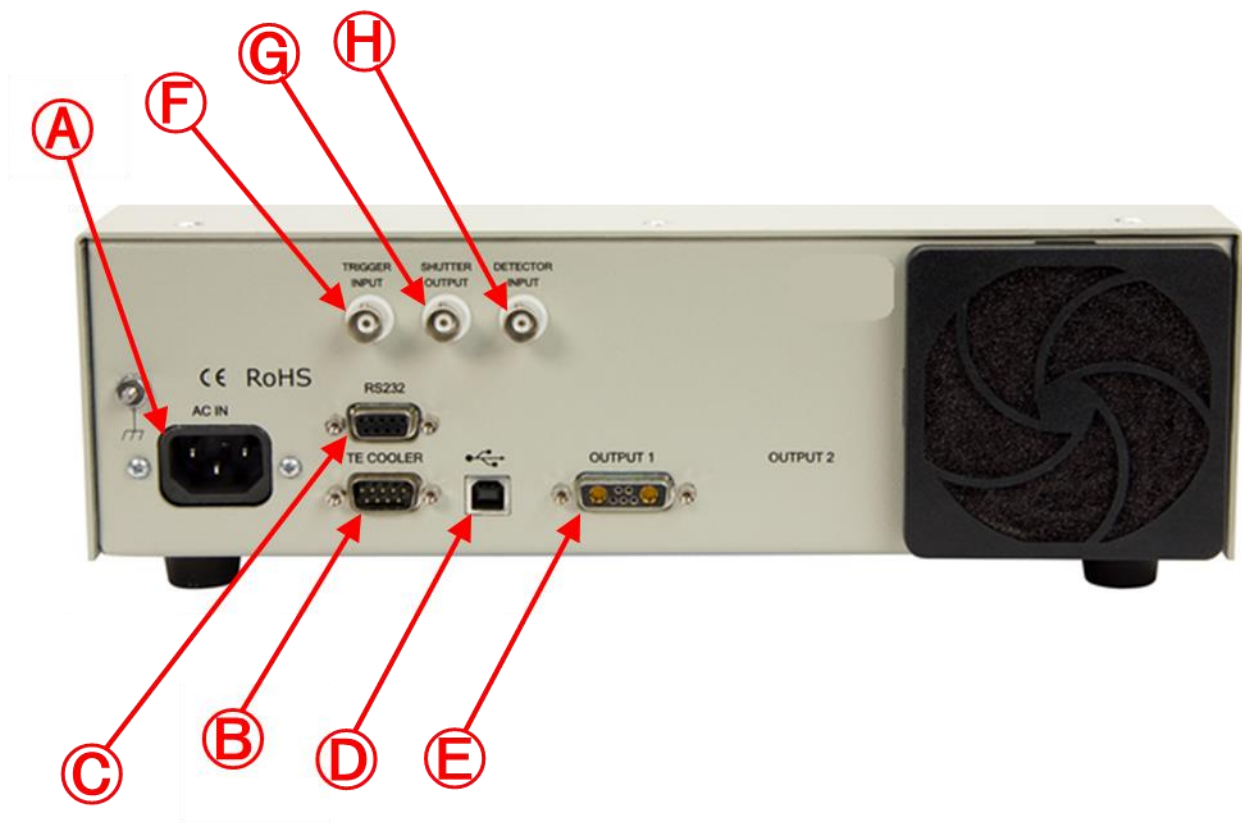

Figure 3 OPS-A Power Supply Rear Panel Connections.

- A. **AC IN.** Before powering up the system for the first time, it is suggested to have a qualified electrician verify the wall socket to be used with the power supply meets the requirements for operation as noted.

The line voltage requirements for the OPS-A150 and OPS-A500 power supplies are as follows:

Model	Input Rating
OPS-A150	95 to 264 VAC, 47 to 63 Hz
OPS-A500	

A dedicated power line or line isolation may be required in certain locations, as the electronics contained in the instrument are sensitive to static electricity and radiated electromagnetic fields. Operation of the system near intense pulsed sources (lasers, Xenon flash lamps, etc.) may compromise performance.

Before making any electrical connections, verify the power switch is in the OFF position for the OPS.

Connect the power cord to the back of the OPS before plugging it into an AC electrical outlet.

	<p>ELECTRICAL SHOCK HAZARD</p> <p>To avoid electric shock, connect the instrument to a properly earth-grounded, 3-prong receptacle only. Failure to observe this precaution can result in severe injury or death.</p> <p>Never attempt to open the power supply. These models do not contain any user serviceable parts. Failure to follow this warning can result in severe injury or death.</p>
---	--

The OPS product family conforms to CE standards for both safety and EMC. During normal use, this equipment will not pose any electrical hazards to the user. Read all warnings before installing or operating this system. **Never open the OPS cover and attempt to work inside.**

Use the power cord provided with the power supply. Never alter the power cord in any way. Be sure to periodically inspect the power cord and replace it if any damage occurs. If a replacement power cord is required, please contact Oriel Instruments and do not attempt to replace the power cord with a similar cord from a third party vendor. Use of a different line cord may not meet the electrical specifications required to use this power supply in a safe manner.

B. TE COOLER. The LIK-LMP light intensity controller kit utilizes a TE cooled Si detector as its light sensing head. The TE COOLER connector on the rear panel of the power supply is for monitoring and controlling the temperature of the Si detector based on the 0-25 ° C temperature control range of the OPS-A Model Power Supply. The cable included in the LIK-LMP (also available separately as a spare cable) is the 70062 Oriel Thermoelectric Cooler to TE Cooled Detectors cable.

C. RS232. The RS232 connector located on the rear panel of the power supply allows for external control of the power supply from a Windows based PC. The Command Set for RS232 control is in Appendix B of this manual.

D. USB. The USB connector located on the rear panel of the power supply is for providing an alternative external control method to RS232. The Command Set for USB control is in Appendix B of this manual.

E. OUTPUT 1. The interconnection cable between the lamp housing and power supply required for which lamp type are noted in the table below. A safety interlock feature does not allow the lamp to start if the cable or cables are not connected. Never alter these cables and do not use if they appear to be damaged. Fully tighten all connections between the lamp housing and the power supply to prevent arcing.

Model	Lamp Type	Lamp Housing Interconnection Cable(s)
OPS-A150	Hg	Oriel model 70051 (Grey)
OPS-A150	Xe	Oriel model 70050 (Black)
OPS-A500	Hg	Oriel model 70051 (Grey)
OPS-A500	Xe, Hg(Xe)	Oriel model 70050 (Black)

If a replacement cable is needed, please contact Oriel Instruments. Oriel Instruments can only guarantee that the OPS Power Supply will meet performance specifications and be operated safely if lamp housing interconnection cables provided by Oriel Instruments as listed in the table above or the table in **Section 8 Interlock Cables/Connections to Lamp Housings** are used. The use of a lamp housing interconnection cable provided by a third party vendor or made on the user's end could damage the power supply and lamp housing and pose an electrical shock risk to the user.

The connector pin assignments are listed in the following table.

Pin	Signal	Description
A1	LAMP (-)	Connection to lamp negative terminal
A2	LAMP (+)	Connection to lamp positive terminal
1	GND	Ground for interlock (fan/elapsed time indicator if in housing)
2	INTERLOCK (+)	Connected to +12V to satisfy interlock
3	+12 VDC	DC voltage for interlock (fan/elapsed time indicator if in housing)
4	IGNITOR DRIVE	Momentary ground connection to fire Newport ignitor
5	INTERLOCK (-)	Connected to GND to satisfy interlock

MATING CONNECTOR:

Body: ITT# DAM-7W2P-K87 (includes pins 1-5)

Pins: ITT# DM 53745-1 (requires 2 per connector, A1 and A2)

Backshell: standard 15-pin D-SUB

	<p>ELECTRICAL SHOCK HAZARD</p> <p>When operating the power supply above 60 V, a significant electrical shock risk is present. Before operating the power supply, please inspect the Lamp Housing Interconnection cable and confirm the cable is securely connected to the power supply and lamp housing. Failure to observe this precaution can result in severe injury or death.</p>
---	--

	<p>CAUTION</p> <p>Do not turn on the power supply until the lamp has been installed and all connections have been made to the power supply and lamp housing.</p>
---	---

	<p>WARNING</p> <p>When the Lamp On button is depressed, the lamp will begin emitting light. Do not press the Lamp On button until the output flange is directed in such a way that people, animals and equipment will not be harmed by the light.</p>
---	--

If there are any questions or concerns, contact Oriel Instruments or the regional sales representative for Newport.

F. TRIGGER INPUT. The BNC connector labeled TRIGGER INPUT is to remotely control the operation of a shutter that is connected to the power supply. A TTL signal may be input to the TRIGGER INPUT connector or a remote switch closure may be wired to the connector.

G. SHUTTER OUTPUT. The BNC connector labeled SHUTTER OUTPUT outputs a TTL signal to an external electronic shutter to open/close the shutter based on the manual or external (RS232/USB) commands input by the user.

H. DETECTOR INPUT. The 71582 detector head of the LIK-LMP light intensity controller kit is a TE cooled Si detector that outputs a current signal proportional to the light output of the lamp, which is input to the power supply via the DETECTOR INPUT BNC connection. This current signal allows the OPS-A Model Power Supply to raise/lower power/current as necessary to maintain a stable light output. This additional level of stability is required for applications that need a highly stable light source or when the user ops to use Intensity or Dosed Exposure operation modes.

3.4.3 Rear Panel Controls/Connections (OPS-1000 model only)

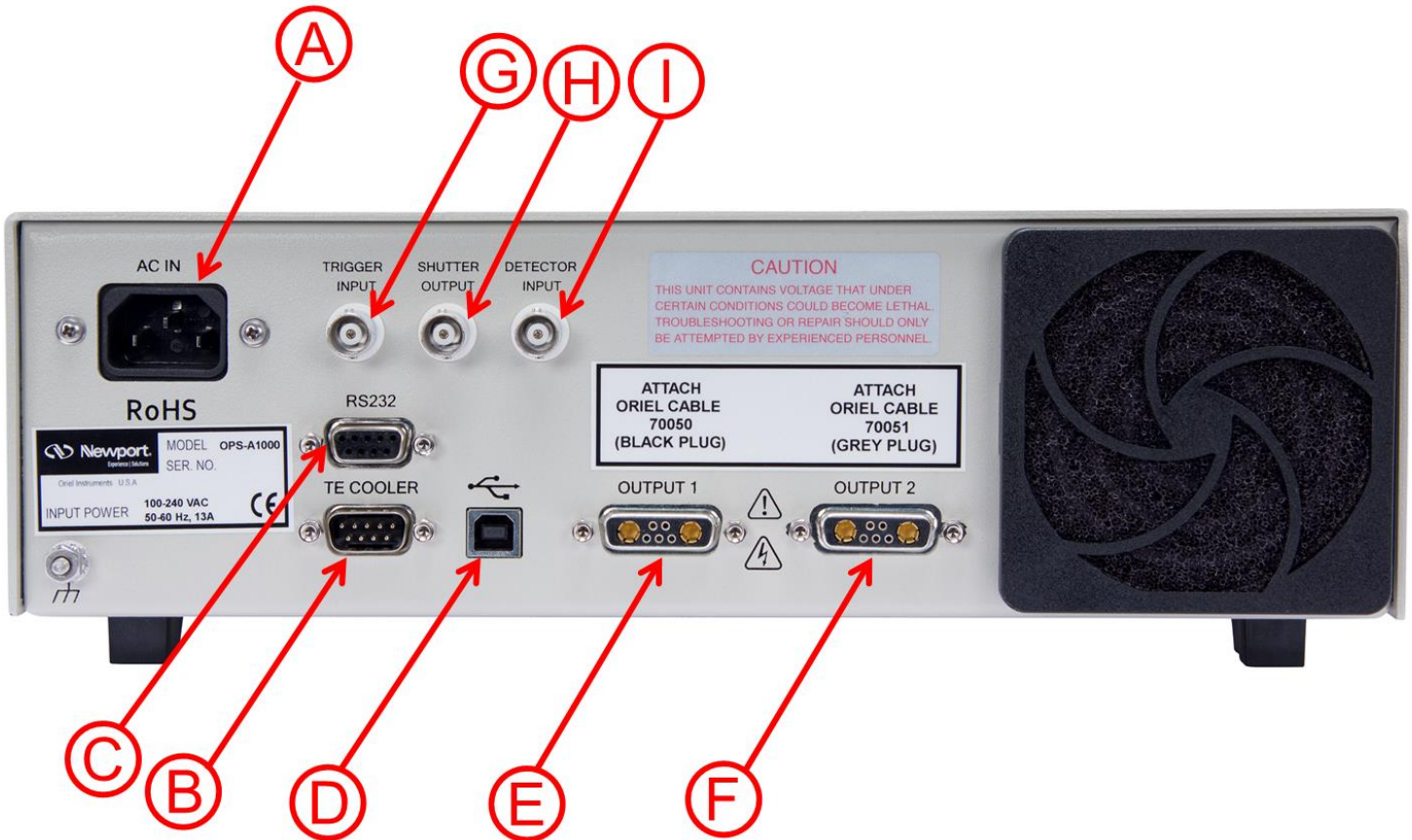

A. AC IN. Before powering up the system for the first time, it is suggested to have a qualified electrician verify the wall socket to be used with the power supply meets the requirements for operation as noted.

The line voltage requirement for the OPS-A1000 is 95-264 VAC, 47 to 63 Hz.

Before making any electrical connections, verify the power switch is in the OFF position for the OPS.

Connect the power cord to the back of the OPS before plugging it into an AC electrical outlet.

	<p>ELECTRICAL SHOCK HAZARD</p> <p>To avoid electric shock, connect the instrument to a properly earth-grounded, 3-prong receptacle only. Failure to observe this precaution can result in severe injury or death.</p> <p>Never attempt to open the power supply. These models do not contain any user serviceable parts. Failure to follow this warning can result in severe injury or death.</p>
---	--

The OPS product family conforms to CE standards for both safety and EMC. During normal use, this equipment will not pose any electrical hazards to the user. Read all warnings before installing or operating this system. **Never open the OPS cover and attempt to work inside.**

Use the power cord provided with the power supply. Never alter the power cord in any way. Be sure to periodically inspect the power cord and replace it if any damage occurs. If a replacement power cord is required, please contact Oriel Instruments and do not attempt to replace the power cord with a similar cord from a third party vendor. Use of a different line cord may not meet the electrical specifications required to use this power supply in a safe manner.

B. TE COOLER. The LIK-LMP light intensity controller kit utilizes a TE cooled Si detector as its light sensing head. The TE COOLER connector on the rear panel of the power supply is for monitoring and controlling the temperature of the Si detector based on the 0-25 ° C temperature control range of the OPS-A Model Power Supply. The cable included in the LIK-LMP (also available separately as a spare cable) is the 70062 Oriel Thermoelectric Cooler to TE Cooled Detectors cable.

C. RS232. The RS232 connector located on the rear panel of the power supply allows for external control of the power supply from a Windows based PC. The Command Set for RS232 control is in Appendix B of this manual.

D. USB. The USB connector located on the rear panel of the power supply is for providing an alternative external control method to RS232. The Command Set for USB control is in Appendix B of this manual.

E. OUTPUT 1. As noted in the label above the connector, the OUTPUT 1 connector is for the 70050 or other black model (70046, 70047) lamp housing interconnection cable. Before attempting to ignite the arc lamp, it is important to confirm that the proper lamp housing interconnection cable is connected to the proper connectors on both the rear panel of the power supply and the Research Lamp Housing. Connecting a lamp housing interconnection cable into the incorrect connector on both the power supply or Research Lamp Housing and attempting to ignite the lamp, can damage both the Research Lamp Housing and the arc lamp inside.

A safety interlock feature does not allow the lamp to start if the cable or cables are not connected. Never alter these cables and do not use if they appear to be damaged. Fully tighten all connections between the lamp housing and the power supply to prevent arcing.

If a replacement cable is needed, please contact Oriel Instruments. Oriel Instruments can only guarantee that the OPS Power Supply will meet performance specifications and be operated safely if lamp housing interconnection cables provided by Oriel Instruments as listed in the table above or the table in **Section 8 INTERLOCK CABLES/CONNECTIONS TO LAMP HOUSINGS** are used. The use of a lamp housing interconnection cable provided by a third party vendor or made on the user's end could damage the power supply and lamp housing and pose an electrical shock risk to the user.

The connector pin assignments are listed in the following table.

Pin	Signal	Description
A1	LAMP (-)	Connection to lamp negative terminal
A2	LAMP (+)	Connection to lamp positive terminal
1	GND	Ground for interlock (fan/elapsed time indicator if in housing)
2	INTERLOCK (+)	Connected to +12V to satisfy interlock
3	+12 VDC	DC voltage for interlock (fan/elapsed time indicator if in housing)
4	IGNITOR DRIVE	Momentary ground connection to fire Newport ignitor
5	INTERLOCK (-)	Connected to GND to satisfy interlock

MATING CONNECTOR:

Body: ITT# DAM-7W2P-K87 (includes pins 1-5)

Pins: ITT# DM 53745-1 (requires 2 per connector, A1 and A2)

Backshell: standard 15-pin D-SUB

	<p>ELECTRICAL SHOCK HAZARD</p> <p>When operating the power supply above 60 V, a significant electrical shock risk is present. Before operating the power supply, please inspect the Lamp Housing Interconnection cable and confirm the cable is securely connected to the power supply and lamp housing. Failure to observe this precaution can result in severe injury or death.</p>
---	--

	<p>CAUTION</p> <p>Do not turn on the power supply until the lamp has been installed and all connections have been made to the power supply and lamp housing.</p>
---	---

	<p>WARNING</p> <p>When the Lamp On button is depressed, the lamp will begin emitting light. Do not press the Lamp On button until the output flange is directed in such a way that people, animals and equipment will not be harmed by the light.</p>
---	--

F. OUTPUT 2. As noted in the label above the connector, the OUTPUT 2 connector is for the 70051 or other grey model (70048, 70049) lamp housing interconnection cable. Before attempting to ignite the arc lamp, it is important to confirm that the proper lamp housing interconnection cable is connected to the proper connectors on both the rear panel of the power supply and the Research Lamp Housing. Connecting a lamp housing interconnection cable into the incorrect connector(s) on both the power supply and/or Research Lamp Housing and attempting to ignite the lamp, can damage both the Research Lamp Housing and the arc lamp inside. A safety interlock feature does not allow the lamp to start if the cable or cables are not connected. Never alter these cables and do not use if they appear to be damaged. Fully tighten all connections between the lamp housing and the power supply to prevent arcing.

If a replacement cable is needed, please contact Oriel Instruments. Oriel Instruments can only guarantee that the OPS Power Supply will meet performance specifications and be operated safely if lamp housing interconnection cables provided by Oriel Instruments as listed in the table above or the table in **Section 8 INTERLOCK CABLES/CONNECTIONS TO LAMP HOUSINGS** are used. The use of a lamp housing interconnection cable provided by a third party vendor or made on the user's end could damage the power supply and lamp housing and pose an electrical shock risk to the user.

The connector pin assignments are listed in the following table.

Pin	Signal	Description
A1	LAMP (+)	Connection to lamp positive terminal
A2	LAMP (-)	Connection to lamp negative terminal
1	GND	Ground for interlock (fan/elapsed time indicator if in housing)
2	INTERLOCK (+)	Connected to +12V to satisfy interlock
3	+12 VDC	DC voltage for interlock (fan/elapsed time indicator if in housing)
4	IGNITOR DRIVE	Momentary ground connection to fire Newport ignitor
5	INTERLOCK (-)	Connected to GND to satisfy interlock

MATING CONNECTOR:

Body: ITT# DAM-7W2P-K87 (includes pins 1-5)

Pins: ITT# DM 53745-1 (requires 2 per connector, A1 and A2)

Backshell: standard 15-pin D-SUB

	<p>ELECTRICAL SHOCK HAZARD</p> <p>When operating the power supply above 60 V, a significant electrical shock risk is present. Before operating the power supply, please inspect the Lamp Housing Interconnection cable and confirm the cable is securely connected to the power supply and lamp housing. Failure to observe this precaution can result in severe injury or death.</p>
---	--

	<p>CAUTION</p> <p>Do not turn on the power supply until the lamp has been installed and all connections have been made to the power supply and lamp housing.</p>
---	---

	<p>WARNING</p> <p>When the Lamp On button is depressed, the lamp will begin emitting light. Do not press the Lamp On button until the output flange is directed in such a way that people, animals and equipment will not be harmed by the light.</p>
---	--

G. TRIGGER INPUT. The BNC connector labeled TRIGGER INPUT is to remotely control the operation of a shutter that is connected to the power supply. A TTL signal may be input to the TRIGGER INPUT connector or a remote switch closure may be wired to the connector.

H. SHUTTER OUTPUT. The BNC connector labeled SHUTTER OUTPUT outputs a TTL signal to an external electronic shutter to open/close the shutter based on the manual or external (RS232/USB) commands input by the user.

I. DETECTOR INPUT. The 71582 detector head of the LIK-LMP light intensity controller kit is a TE cooled Si detector that outputs a current signal proportional to the light output of the lamp, which is input to the power supply via the DETECTOR INPUT BNC connection. This current signal allows the OPS-A Model Power Supply to raise/lower power/current as necessary to maintain a stable light output. This additional level of stability is required for applications that need a highly stable light source or when the user ops to use Intensity or Dosed Exposure operation modes.

3.5 INITIAL START-UP SCREEN

Upon powering up the OPS-A Model Power Supply. The following screen will appear on the power supply's LCD:

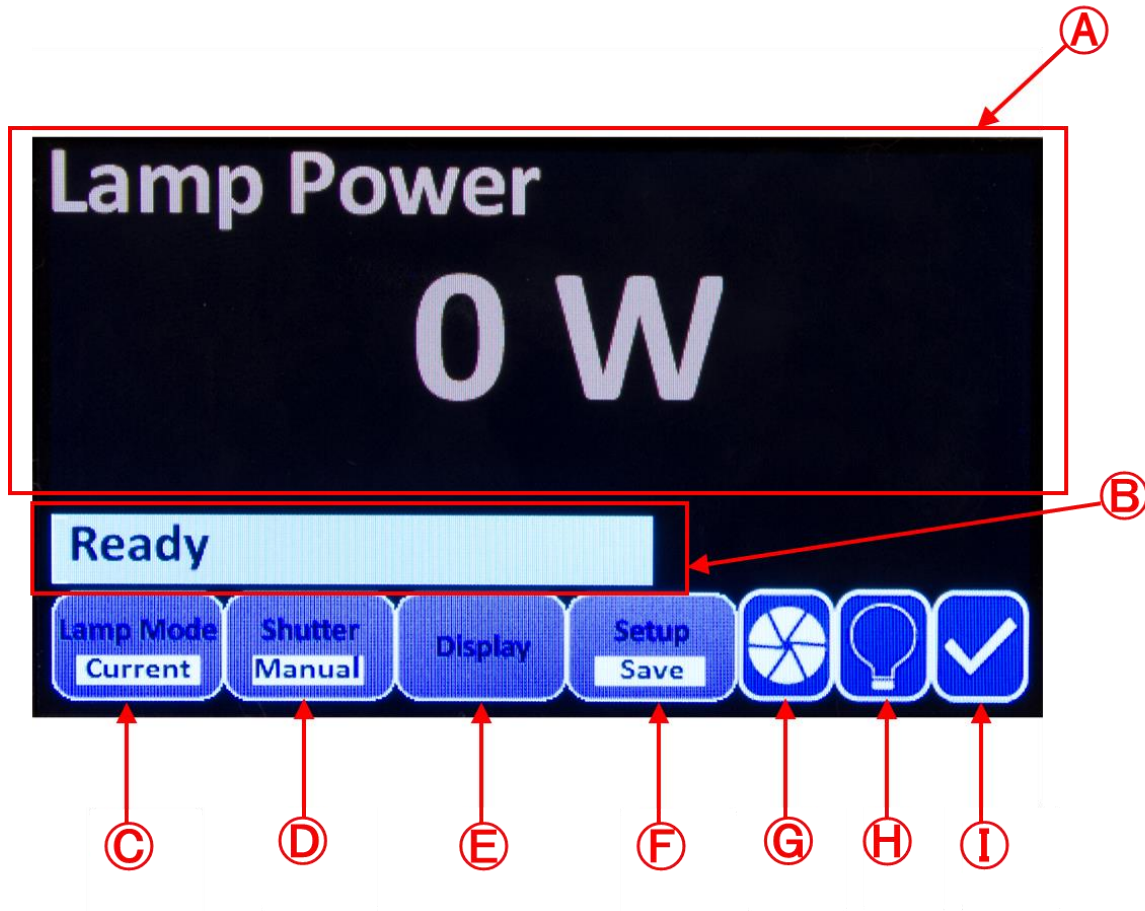

Figure 4 The LCD display of the OPS-A Model Power Supply.

- A. The main section of the LCD screen displays the desired parameter as selected by the user and will be used for menu navigation.
- B. This portion of the LCD screen displays a “Ready” status indicating the power supply and related components (lamp, lamp housing, cable(s)) are prepared for lamp ignition, or displays “Interlock Open,” indicating a problem with the system setup. Similar error messages such as “Cooler Not Ready” when using the LIK-LMP Light Intensity Controller kit and “Function Not Available” may also be displayed here. The meaning of these error messages and troubleshooting techniques are explained in the relevant portions of this manual.
- C. **Lamp Mode.** The operating mode as designated by the user will be displayed by this indicator.
- D. **Shutter.** The setting of the shutter, manual or timed, as designated by the user will be displayed here.

- E. Display.** Pressing the horizontal menu button under this icon will reveal the vertical menu listing the display options available by the OPS-A Model Power Supply.
- F. Setup.** Pressing the horizontal menu button under this icon will allow the user to Save and Load preferred settings, reset the amount of hours the OPS-A has been recording for the current lamp in use, and access other functions of the power supply. More details on the functions accessible with the menu button under this icon are explained throughout this manual.
- G. Shutter Indicator.** This icon displays the open/close status of the shutter.
- H. Lamp Indicator.** This icon displays the ignition status of the lamp.
- I.** This icon will display either a Check Mark, indicating lamp housing connections and lamp housing door are properly secured, or an Exclamation Point, indicating the connections and/or door previously referenced need to be re-examined for secure connection(s)

4 QUICK START GUIDE

4.1 SETTING LAMP PARAMETERS

1. Press the horizontal menu button under the Lamp Mode icon. If Power Mode is desired, press the horizontal menu button under the Lamp Mode indicator until Power appears under Lamp Mode. If Current Mode is desired, press this menu button until Current appears under lamp mode.
2. Upon choosing a lamp mode the operating power/current (Pset/Iset) and maximum operating power/current (Pmax/Imax) will appear on the vertical menu. Press the vertical menu button next to Pset/Iset and use the knob to set this parameter when a red bullet appears next to the current value. Then, set Pmax/Imax. This is typically set to 10% above the rated power/current for the lamp being used.

Be aware that the Imax setting will determine the maximum current the power supply will supply to the lamp, even if the lamp is being operated in Power mode. If the lamp is being operated in Power mode and not reaching the Pset as directed by the user, turn off the lamp. Then, increase Imax while staying within the lamp's maximum current specification. Revert back to Power operation mode and ignite the lamp.

Please note that Power, Current, and Intensity Modes share the same Imax setting. Changing the Imax setting in one mode of operation will change the Imax setting for the other modes of operation. Before igniting the lamp, the maximum specifications should be confirmed and preset by the user to avoid damage to the lamp.

4.2 TURNING THE LAMP ON/OFF

When the lamp parameters have been set, press the LAMP button on the front panel. For an arc lamp, ignition will occur immediately upon pressing the LAMP button.

4.3 LIGHT INTENSITY CONTROL

1. The flux set point must be set first. There are two ways to set the flux set point:
 - A. AutoSet method:
 - i. Use “Current” or “Power” mode to turn ignite the lamp first
 - ii. Press the horizontal menu button under “Display” and select “Lamp Intensity” using the external knob.
 - iii. Press the right most horizontal menu key under Setup until the vertical menu with CoolTemp, Idle, and Autoset appears.
 - iv. Press the “AutoSet” button, the system will automatically adjust the gain of the flux amplifier and set the flux set point to be 90% of current flux reading
 - v. Turn off lamp
 - B. Manual method:
 - i. Use “Current” or “Power” mode to turn ignite the lamp first.
 - ii. Press the horizontal menu button under “Display” and select “Lamp Intensity” using the external knob.
 - iii. Record this value. This value is to be used as the “Flux Set” set point.
 - iii. If the recorded value shows value of 2.5uA, 25uA or 250uA or 2500uA, this indicates that the flux reading has overflowed with existing gain of flux amplifier. If this occurs, the Autoset Method described above should be used.
 - iv. Turn off the lamp.
 - v. Press the horizontal menu key under “Lamp Mode” and continue this button until Intensity appears.
 - vi. When Intensity appears, press the vertical menu button next to Flux Set. Use the knob to change this value to 10% greater than the Flux Set point just recorded.

Users who used the Manual Method described above to establish a Flux Set point can skip Steps 2 and 3 and proceed with pressing the LAMP button to operate the lamp.

2. To change the lamp control mode, use the horizontal menu key under “Lamp Mode” and press this button until Intensity appears.
3. Once Intensity mode is selected, press the vertical menu key next to Flux Set and use the knob to adjust this value. Press the LAMP button to ignite the LAMP.

4. When in “Intensity” mode, if the signal output and/or TE cooler cables connecting the power supply to the 71582 light intensity control kit detector are not connected properly, “Cooler Not Ready” may appear on the message bar of the LCD screen. If this appears, inspect the cables to confirm secure connections.

5 OPERATING MODES

5.1 POWER MODE

In power mode, the lamp is operated at a constant power setting. As the voltage cannot be changed, the current is raised or lowered to maintain the power at the same level. As the lamp ages, the radiant output decreases. As an IR emitter ages, its resistance may double. However, the lamp life is prolonged.

5.2 CURRENT MODE

In current mode, the lamp is operated at a constant current setting. As the voltage cannot be changed, the power is raised or lowered to maintain the current at the same level. As the lamp ages, the power is increased. This results in greater optical output which to some extent may help compensate for a darkening lamp envelope. However, the lamp life is reduced due to the increase in power.

5.3 INTENSITY MODE

Light intensity mode allows the user to increase or decrease the output intensity of the lamp from a Flux Set point. In order operate the lamp in Intensity Mode, the LIK-LMP Light Intensity Controller Kit (sold separately) from Oriel Instruments is required. The LIK-LMP light intensity kit includes a TE cooled detector, and all the necessary adapters and cables for mechanical and electrical compatibility with the lamp housing (both 60000 Q Series and 50-1600 W Oriel Research Arc Lamp Housings adapters included) and OPS model power supply. If a calibrated photodiode or other current output detector was used to determine the desired output intensity of the lamp, the flux (labeled as Output Intensity) displayed on the LCD screen of the power supply can be adjusted to match the current output of the calibrated detector by the use of the Flux Multiplier Function. With the use of the LIK-LMP, Intensity Mode ensures stable operation of the established flux set point of the lamp over long operation periods.

5.3.1. Dosed Mode

Dosed mode is a special operating feature of Intensity Mode. When the lamp is in intensity control mode and a TTL shutter is used, a user can set the Dose for the lamp to output. A Dose consists of a flux and a time interval. When a user sets a flux set point in intensity mode and switches to dose mode, a Dose should be specified by the user. The user should also specify the time interval for the shutter to remain closed in between individual exposures of this Dose, and the amount of cycles he/she would like this Dosed exposure to repeat for. Time is not directly set by the user, the time interval the shutter remains open allowing the lamp to directly output light is determined by the power supply based on the flux set point and the Dose as desired by the user. While operating in Dosed mode a user can Stop a cycle of exposures, pause the current cycle while the shutter is closed, or reset the Total Dose the lamp has output thus far as recorded by the power supply.

6 POWER AND CURRENT OPERATION MODES

6.1 POWER OPERATION MODE

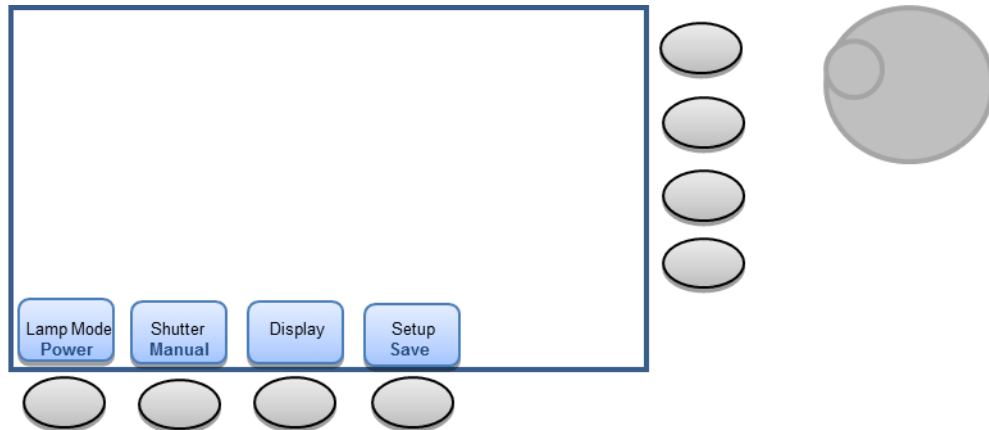

1. Press the horizontal menu button under the Lamp Mode icon on the LCD display until the text under Lamp Mode reads power as shown in the figure above. Upon reaching the Constant Power mode option, the vertical menu for setting the lamp operating power (Pset) and maximum power to be supplied to the lamp (Pmax) will appear as shown above.

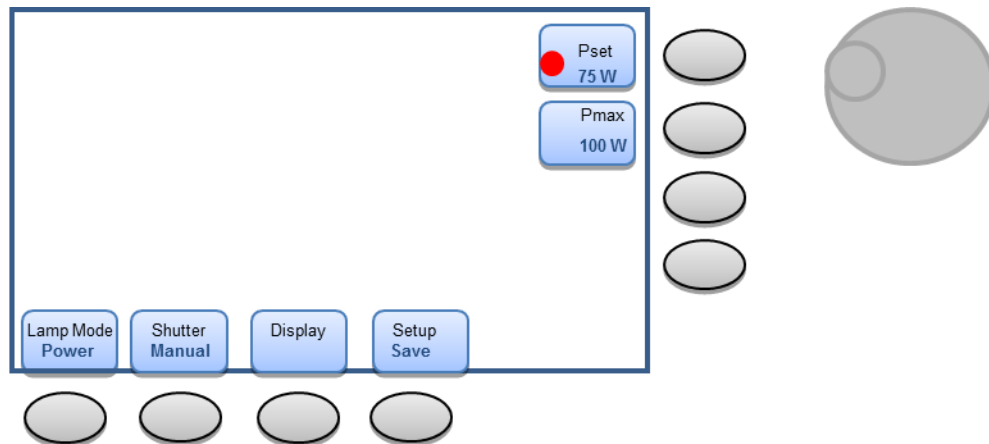

2. To adjust the Pset and Pmax, press the vertical menu button next to each parameter. A red bullet in the box indicating that particular parameter can be changed will appear. That parameter can now be changed by rotating the knob to the right of the vertical menu buttons. Be aware that Pmax cannot be changed when the lamp is ignited.

Note. If using a lamp purchased from Newport Corporation, set Pset to the desired operating power. Pmax is typically set at 10% higher than the lamp rating. If not using a lamp purchased from Newport Corporation, it is best to follow operation power and maximum power supply guidelines determined by the lamp manufacturer.

3. Press CLEAR to clear the vertical menu from the screen and observe the desired operating parameter in real time while the lamp is being operated. The lamp is now ready for ignition.

If the “Warning I_{max} Setting” message appears on the screen as shown below while the power supply is being operated in Power Mode, this indicates that the I_{max} setting in Current Mode is set too low for the lamp to reach the desired Pset.



If this error message appears, power down the lamp. Then, change Lamp Mode to Current Mode as described in the next section. Increase the I_{max} parameter while staying safely within the lamp’s maximum input current specification. Return to Power Mode and ignite the lamp. The power supply will now be able to supply enough current to the lamp to reach the desired Pset.

6.2 CURRENT OPERATION MODE

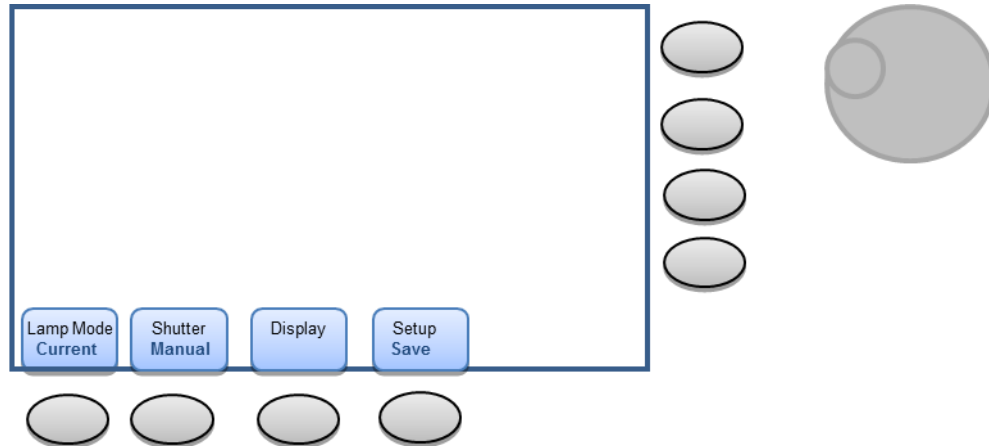

1. Press the horizontal menu button under the Lamp Mode icon on the LCD display until the text under Lamp Mode reads Current as shown in the figure above.

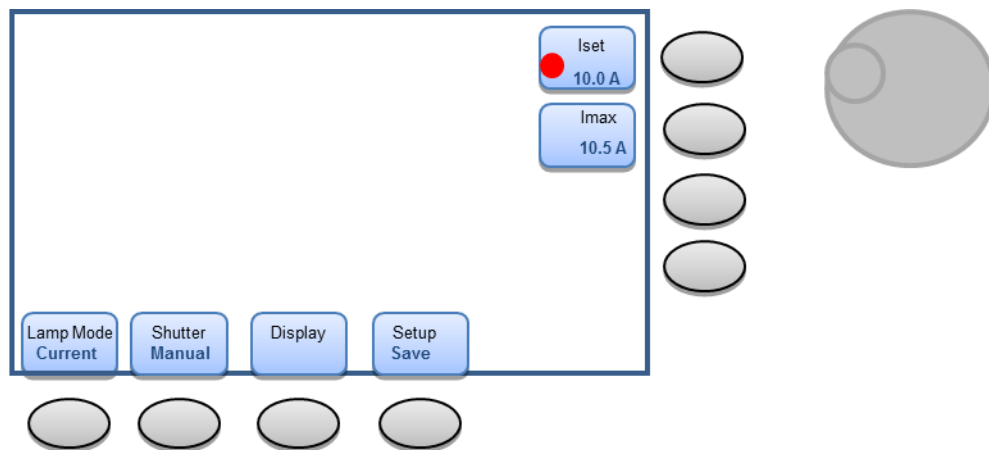

2. Upon reaching the Constant Power mode option, the vertical menu for setting the lamp operating current (Iset) and maximum current to be supplied to the lamp (Imax) will appear as shown on the next page.
3. To adjust the Iset and Imax, press the vertical menu button next to each parameter. A red bullet in the box indicating that particular parameter can be changed will appear. That parameter can now be changed by rotating the knob to the right of the vertical menu buttons. Be aware that Imax can only be changed when the lamp is not ignited.

Note. If a lamp that was not purchased from Newport Corporation is being used, use the manufacturer's current specifications for operation. If the lamp operating power and voltage are known but the operating current is not, determine the current setting by using Ohm's Law: $\text{Amperes} = \text{Power} \div \text{Voltage}$

4. Press CLEAR to clear the vertical menu from the screen and observe the desired operating parameter in real time while the lamp is being operated. The lamp is now ready for ignition.

Please note that the lamp operation mode cannot be changed while the lamp is being operated. If the operating mode is to be changed, power off the lamp and change the lamp operation mode before reigniting the lamp.

7 FIRMWARE AND MODEL INFORMATION

To confirm the current firmware version of the OPS-A Model Power Supply Press the rightmost horizontal menu button until the System 1 menu appears under Setup as shown on the next page:

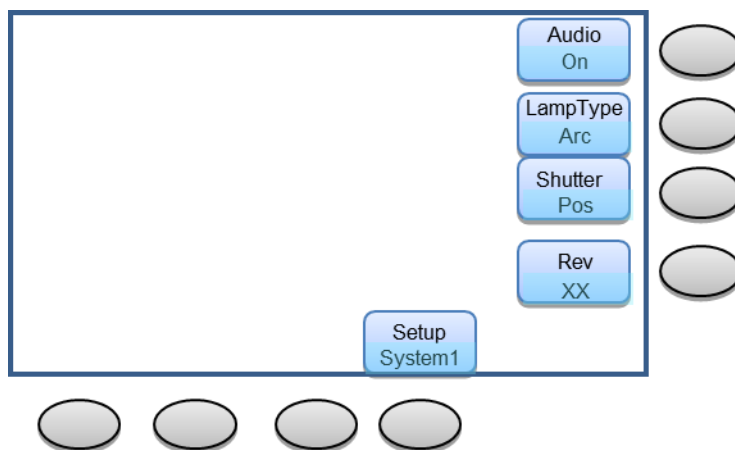

Audio. To make the OPS-A Model Power supply emit an audible alarm when errors such as “Ignition Failure,” select the On option for Audio. Selecting the Off option will cause the power supply to be silent when such error messages appear on the LCD screen. This option can be changed by pressing the vertical menu key and using the external knob to select On or Off when a red bullet appears to the left of the current Audio setting.

LampType. This is a read only setting. For the OPS-A Model Power Supplies, this setting will always read Arc to indicate this power supply is for use with DC Arc Lamps.

Shutter. To change the polarity of the TTL signals from the SHUTTER OUTPUT connector on the rear of the power supply, press the vertical menu button next to this indicator. When a red bullet appears to the left of the current Shutter setting use the knob to select Pos, indicating a positively biased TTL pulse will be sent to an external shutter or Neg, indicating a negatively biased TTL pulse will be sent to an external shutter.

Rev. This is a read only setting used to confirm the current firmware version of the OPS-A Model Power Supply.

7.1 UPDATING THE FIRMWARE

If firmware updates crucial to the operation of the power supply or LCD screen graphic updates (LCD GUI) are made in the future, these updates will be available on the Newport website (<http://www.newport.com/>). Updates can be done as firmware only, image only, or both firmware and image by simply copying the desired files into the root directory of a USB flash drive.

The firmware naming format will be ntpsuxxx.hex, with XXX being the version number of the firmware (000-999). Both ntpsuxxx.hex and NTPSUXXX.hex are acceptable names for the firmware update. During the update the bootloader of the OPS Power Supply will confirm that the firmware version on the USB flash drive is different from the current version used by the power supply. As long as the firmware version on the USB flash drive is different from that of the power supply, the firmware update (or reversion if a previous version exists on the USB flash drive) will occur.

The LCD GUI image file naming format will be imNN_XXX.hex, with NN being the image number (0-5) and XXX being the version number of the firmware (000-999). During the update the bootloader of the OPS Power Supply will confirm that the image file on the USB drive is different from the current version used by the power supply. As long as the LCD GUI version of the USB drive is different from that of the power supply, the image update (or reversion) will occur.



Figure 5 USB Connector for Firmware Updates.

FIRMWARE UPDATE PROCEDURE

1. Copy the new firmware file and/or new LCD GUI image file into the root directory of a USB flash drive.
2. With the OPS Model Power Supply turned off, insert the USB flash drive into the USB slot on the front panel of the power supply.
3. Turn on the power supply.
4. The LCD screen should display the following image:



Figure 6 The LCD screen image displayed during firmware and LCD GUI interface updates.

5. When the update has been completed, the LCD will display the regular LCD GUI interface.
6. If the update involved a firmware update, confirm the firmware update was successful by confirming the firmware version as shown by the procedure explained previously in this section of the manual.

8 INTERLOCK CABLES/CONNECTIONS TO LAMP HOUSINGS

A lamp interconnection cable must be purchased for use with an arc lamp housing, based on the type of lamp being utilized. Replacement cables may also be purchased if needed. Interconnection cables are available on Newport.com.

Model	Lamp Type	Lamp Housing Interconnection Cables (6 foot, 12 foot or 20 foot lengths)	Cable Color
OPS-A150	Hg	Oriel model 70051, 70048 or 70049	Grey
OPS-A150	Xe	Oriel model 70050, 70046 or 70047	Black
OPS-A500	Hg	Oriel model 70051, 70048 or 70049	Grey
OPS-A500	Xe, Hg(Xe)	Oriel model 70050, 70046 or 70047	Black
OPS-A1000	Hg, Hg(Xe),	Oriel model 70051, 70048 or 70049	Grey
OPS-A1000	Xe	Oriel model 70050, 70046 or 70047	Black

For the OPS-A150 and OPS-A500 model power supplies, connect the proper lamp housing interconnection cable into the OUTPUT 1 connector on the power supply and electrical connector on the Resarch Lamp Housing, as directed in the table earlier in this section of the manual.



Figure 7 The output connector on the rear panel of the OPS-A150/OPS-A500 Power Supply for interface with Oriel Lamp Housing. The 70050 (Black) and 70051 (Grey) Lamp Housing Interconnection Cables are also shown.

For the OPS-A1000 model power supply, both a gray and black lamp housing interconnection cable must be used for sufficient input voltage and current supply to ensure ignition and stable operation. The label on the rear panel of the OPS-A1000 power supply instructs which OUTPUT port is designed for each color lamp housing interconnection cable.



Figure 8 Labels on the OPS-A1000 Power Supply and Research Lamp Housing indicating the proper connector for each type lamp housing interconnection cable.

If a replacement cable is needed, please contact Oriel Instruments. Oriel Instruments can only guarantee that the OPS Power Supply will meet performance specifications and be operated safely if lamp housing interconnection cables provided by Oriel Instruments as listed in the table on the previous page are used. The use of a lamp housing interconnection cable provided by a third party vendor or made on the user's end could damage the power supply and lamp housing and pose an electrical shock risk to the user.

8.1 CONNECTION TO A Q SERIES TYPE HOUSING

For connecting the OPS-A Series Power Supply to a Q Series Type Housing, use the proper cable to suit the type of DC arc lamp used as designated in the table on the previous page and the Arc Lamp Interface with Ignitor that has been coupled to the housing. Connect this 5 pin connector on the Arc Lamp Interface Kit to the input connector under the label OUTPUT 1 on the rear panel of the power supply.



Figure 9 The Arc Lamp Interface with Ignitor with 5 pin connector for electrical connection to a suitable power supply.

8.2 CONNECTION TO A RESEARCH LAMP HOUSING

8.2.2 Connecting the OPS-A250/OPS-A500 to a Research Lamp Housing

For connecting the OPS-A250 or OPS-A500 to a Research Lamp Housing, use the proper cable to suit the type of DC arc lamp used as designated in the table early in this section and the label fixed to the Research Lamp Housing. Connect this 5 pin connector on the Arc Lamp Interface Kit to the input connector under the label OUTPUT 1 on the rear panel of the power supply.



Figure 10 The electrical connector for interface with OPS-A Model Power Supply on an Oriel Research Lamp Housing.

8.3.3 Connecting the OPS-A1000 to a Research Lamp Housing

For connecting the OPS-A1000 model power supply to a Research Lamp Housing, connect the lamp housing interconnection cables into the proper connectors as directed by the label on the rear panel of the power supply. A similar label is located on the Research Lamp Housing, directing which color cable is intended for which connector.



Figure 11 The label directing which electrical connector to use for each lamp housing interconnection cable on a 450-1000 W Research Lamp Housing.

8.3 SAFETY INTERLOCK

Newport's Oriol Power Supplies have a safety interlock feature which must be satisfied before the power supply will power the lamp and which, if broken during operation, will disable the power supply. Overheating of the housing or accidental opening of the door will automatically shut down the power supply. If the Interlock Open and alert symbol shown below appear on the LCD interface on the power supply during operation, it is recommended that all connection cables be connected for loose connections and the door of the lamp housing be confirmed as completely closed and secured.

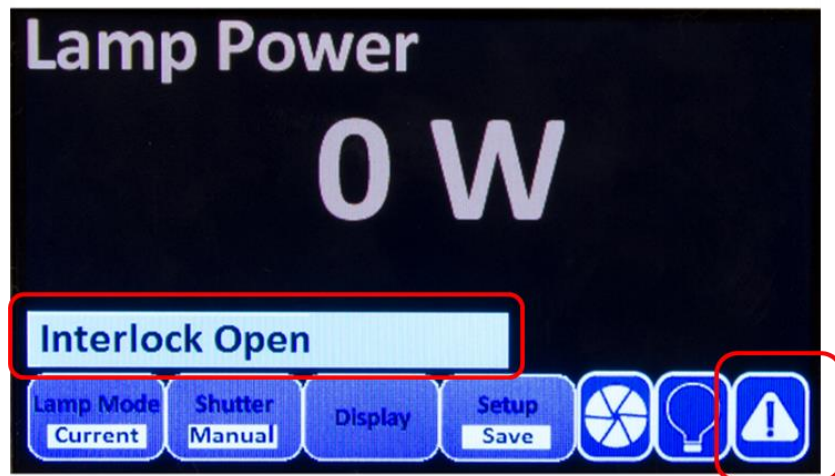

Figure 12 The Interlock Open and warning symbol indicator of the power supply indicates a cable is disconnected and/or the lamp housing is open.

9 DETECTOR THERMOELECTRIC COOLING (APPLICABLE FOR LIK-LMP)

Although the OPS-A Series Power Supply outputs a highly stable voltage and power output with minimum ripple, users may notice instable output of the lamp. This is due to factors beyond the control of the power supply such as lamp aging, ambient temperature fluctuations, and electrode erosion. For applications in which especially high light output stability is required or for operation of the power supply in Light Intensity control mode, the LIK-LMP Light Intensity Controller Kit, offered by Oriel Products be used with the OPS-A Model Power Supply, is required.



Figure 13 The LIK-LMP Light Intensity Controller Kit couples to the Series Q or Research Lamp Housing chosen by the user and includes the necessary cables to connect the LIK-LMP to the OPS-A Power Supply.

Instructions on how to setup and operate the LIK-LMP with the OPS-A Power Supply begin on page 36 of this manual.

The LIK-LMP uses the 75182 detector head, which houses a Thermoelectrically Cooled Silicon Photodiode as its light sensor. The 75182 outputs a current value directly proportional to the output power of the lamp. As conditions beyond the power supply's control mentioned above begin to change the lamp's output, the 75182 relays a different current value to the OPS-A Power Supply. To keep the lamp output power constant to the operator's selected preference, the OPS-A Power Supply constantly changes its output current/power based on the output current of the 75182. This allows the user to have a consistent, stable lamp output throughout the entirety of the lamp's lifetime.

For any photoconductive device such as the 75182, output current is ideally only the result of input light on the active area of the detector. However, unavoidable conditions such as ambient temperature and leakage current cause the detector to output dark current, which is a current output that is not the result of light incident on the active area of the detector. The predominant cause of dark current is thermionic emissions, in which the detector outputs a current value as a result of ambient temperature. To counteract this, silicon photodiode of the 75182 is thermoelectrically cooled, meaning that the light sensing silicon wafer is mounted on a Peltier cooler. This Peltier cooler maintains the temperature of the silicon substrate at a temperature of 0-25 ° C based on the user's setting of the OPS-A Model Power Supply. Stated simply, a lower silicon detector temperature results in a more accurate light intensity

reading. A more accurate light intensity reading allows the OPS-A Model Power Supply to more accurately determine the proper current/power to supply to the lamp to keep output power constant.

To change the temperature of the 75182, press the horizontal menu button under the Setup icon on the LCD interface until the vertical menu showing CoolTemp, Idle, and AutoSet appear on the right as shown on the next page.

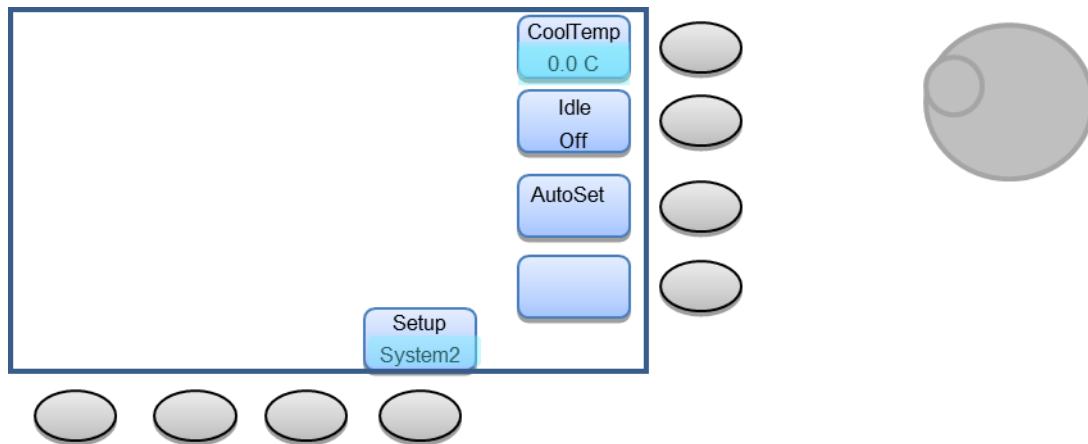

Figure 14 Setting the TE Cooler Temperature

When the menu above appears on the LCD interface, press the vertical menu button next to CoolTemp. The knob on the front panel of the OPS-A Power Supply can then be used to select a detector temperature from 0-25 ° C. The temperature initially shown when this menu is accessed is the temperature set during the last operation involving the use of the 75182.

The error message “Cooler Not Ready” may be observed on the LCD screen. If this error message appears, the connections of the 70062 cable to its appropriate connectors on the rear panel of the OPS-A power supply and 71582 housing should be re-inspected for a secure connection.

If the 70062 TE COOLER and 70018 BNC cables are securely connected to the rear panel of the power supply and the rear panel of the 71582, and this error message appears, the CoolTemp setting needs to be adjusted. Sometimes external conditions such as an ambient operating temperature higher than typical room temperature (21.3° C) can prevent the OPS-A Power Supply from being able to regulate the temperature of the 71582 to the user desired setting. If this occurs, it is advised to access the System2 menu of the Setup Screen and increase/decrease the CoolTemp setting as required. If the current CoolTemp setting is within 13-25 ° C, decrease the Cool Temp setting. If the current CoolTemp setting is within 0-12 ° C, increase the Cool Temp setting. Continue increasing/decreasing the CoolTemp setting as directed until the error message is no longer displayed.

10 INTENSITY OPERATION MODE (LIK-LMP REQUIRED)

Intensity Operation Mode of the OPS-A Model Power Supply requires the use of the LIK-LMP Light Intensity Controller kit (sold separately), also from Oriel Instruments. With the help of the 71582 TE Cooled Detector head used to monitor and relay constant feedback of the lamp output to the OPS Power Supply as described previously in

9 DETECTOR THERMOELECTRIC COOLING, a specific output intensity can be established by the user, monitored, and maintained over long periods of operation.

For applications in which a precise monochromatic or luminous light power is required, a user may first need to adjust current/power supplied to the lamp while using a photosensor calibrated to NIST or other strict standards. When the lamp has been confirmed to output the required power with the calibrated sensor, the output current of the 71582 in response to this same lamp output can be recorded. Intensity Operation Mode of the OPS-A Model Power Supply can be used to ensure the lamp maintains a stable output at this pre-determined operating point. The reason why a sensor calibrated to NIST or other widely recognized standards should not be used during the actual operation of the lamp and only during setup, is because calibration service is expensive and requires a user to send his/her detector to the metrology lab. Repeated or extended use of the sensor increases the frequency at which the photosensor must be returned for re-calibration. The OPS-A Model Power Supply is also specifically designed to control and maintain the operating temperature of the 71582 through its built-in TE cooler, and adjust power/current to the lamp to maintain the lamp's output based on the detector's output current. Establishing a correlation between the output of the calibrated sensor and 71582 at the same light level allows the lamp to be controlled with highly stable output by the feedback of a non-calibrated detector, saving the user money and the temporary inconvenience of not having a calibrated detector. For additional convenience of the user, the Flux Multiplier function of the OPS-A Model Power Supply can be used to adjust the displayed Lamp Intensity on the LCD screen to the same current value as recorded by the calibrated sensor. This allows the 71582 to mimic the performance of a calibrated sensor at that preset operating point of the lamp.

To first use the OPS-A Model Power Supply in operation mode, the LIK-LMP must be attached to the lamp housing or be placed within the light path of the lamp output. If direct mounting to the lamp housing is desired, follow the procedure below for mounting to an Oriel Products housing:

The LIK-LMP contains:

Part Number	Description
71582	TE Cooled Detector Head
70062	Oriel Thermoelectric Cooler to TE Cooled Detectors Cable
70018	Oriel Thermoelectric Cooler to TE Cooled Detectors Cable
68952	Adapter Kit, Research Lamp Housing to Light Intensity Controller/Timer
68954	Adapter Kit, Q Series Lamp Housing to Light Intensity Controller/Timer

10.1 Mounting the LIK-LMP to a Q Series or Research Lamp Housing

1. If an Oriel Products Series Q Housing is being used, use the 68954 Adapter Kit to couple the 71582 detector head to the Series Q Housing. If an Oriel Products Research Lamp Housing is being used, use the 68952 Adapter Kit to couple the 71582 detector head to the Research Lamp Housing. Both mounting examples are shown below:

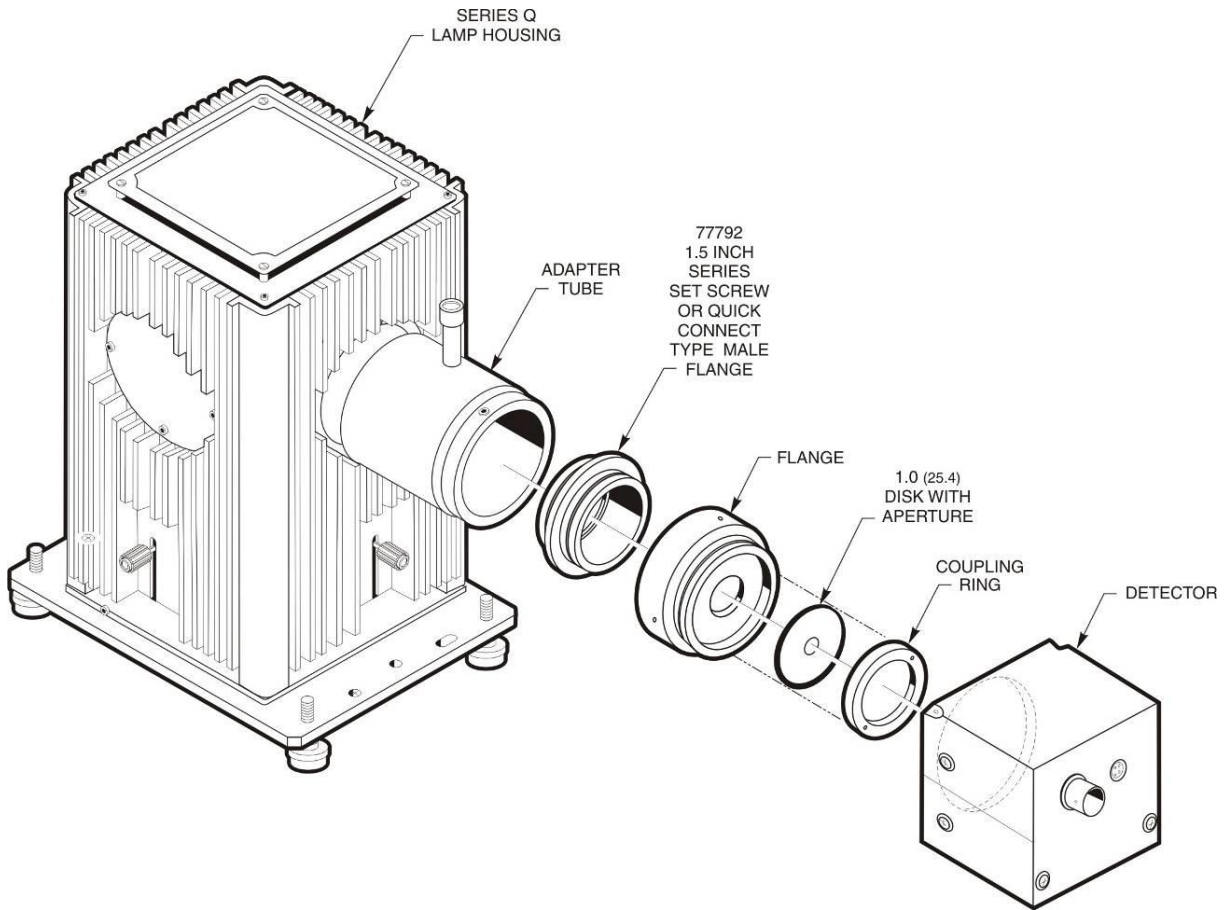

Figure 15 Exploded view of 71582 mounting to a Q Series Housing using the 68954 Adapter Kit.

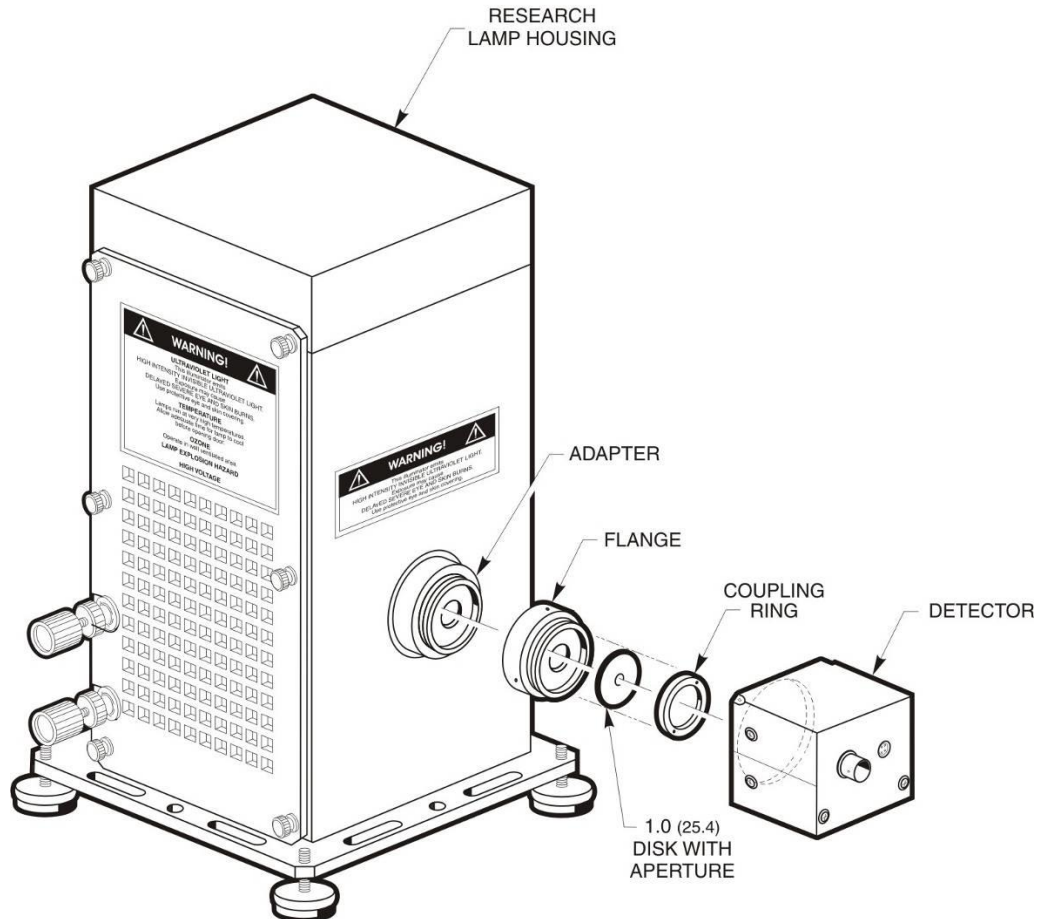

Figure 16 Exploded view of 71582 mounting to a Research Lamp Housing using the 68952 Adapter Kit.

2. Connect the 4 pin connector end of the 70062 cable to the 4 pin output connector on the rear of the 71582 Detector Head. Then, connect the 9 pin input connector on the other end of the 70062 to the 9 pin connector head on the rear panel of the OPS-A Power Supply under the label marked TE COOLER. Complete the connections by connecting the 70018 BNC cable to the BNC connector output on the rear of the 71582 Detector Head and the BNC connector under the label on the rear panel of the power supply marked DETECTOR INPUT.

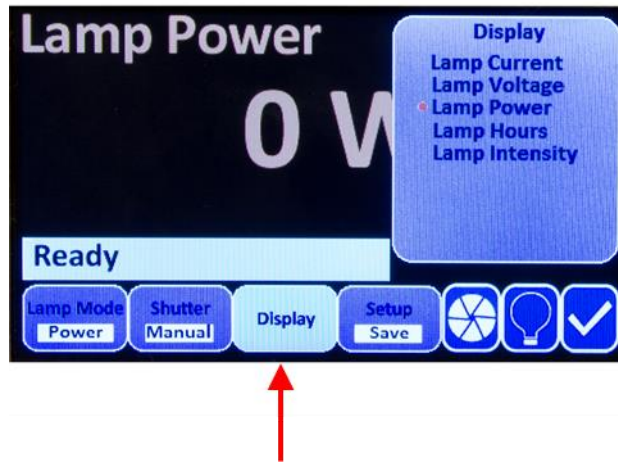

Figure 17 The DETECTOR INPUT and TE COOLER output ports are for direct use of the LIK-LMP with the OPS-A Power Supply.

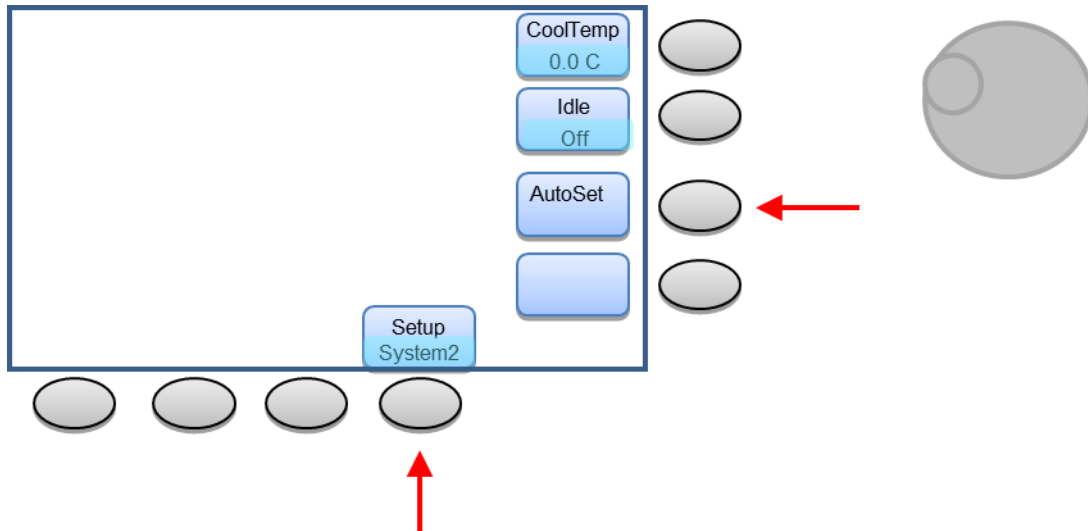

Figure 18 The 70062 (left) and 70018 (right) required for interfacing the 71582 Detector Head with OPS-A Arc Lamp Power Supply.

3. Ignite the lamp using either the Power or Current Operation Modes described earlier in this manual. The Pset/Iset can be adjusted to achieve the desired lamp output power as described previously in this section.



4. Press the horizontal menu button under the Display indicator on the LCD screen and observe the vertical Display menu appear on the right of the screen. Use the knob to the right of the LCD screen to toggle the display to Lamp Intensity as indicated by the red dot to the left of each option. Then, press the CLEAR button to clear the Display menu and observe the current output of the 71582 Detector Head.



5. Press the horizontal menu button under the Setup indicator on the LCD display until System 2 appears with the corresponding vertical menu shown above. Then press the vertical menu button to the right of the AutoSet indicator. This automatically adjusts the gain of the flux amplifier (internal to the OPS-A Power Supply) and sets the displayed flux set point to be 90% of the current flux reading. This is to prevent the user from adjusting the value out of the 1-2450 μA Intensity Control Range if use of the Flux Multiplier is required.
6. Turn off the lamp.
7. Press the horizontal menu button under the Lamp Mode indicator on the LCD display until Intensity Mode with the corresponding vertical menu as shown below appears:

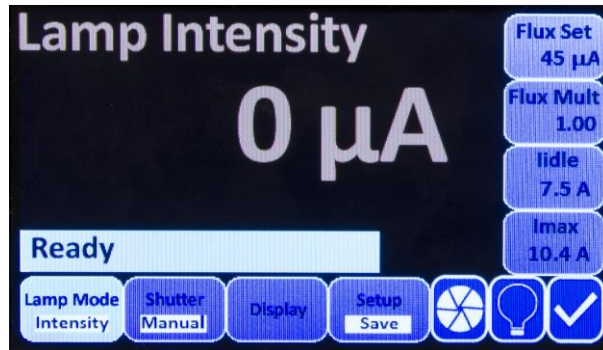

Figure 19 Selecting Intensity Mode as the Operating Mode of the OPS-A Power Supply.

Each changeable parameter on the vertical menu that appears when selecting Intensity mode is defined below:

Flux Set- Flux Set is the output current of the 71582 detector head of the LIK-LMP. If the Autoset process in Step 4 was used prior to changing the lamp operating mode to Intensity Mode, the Flux Set value will display the Autoset value. If Autoset was not used to establish a Flux Set point prior to changing operation of the power supply to Intensity Mode, the Flux Set value the default Flux Set value of the power supply or the last Flux Set value last used when the power supply was operated in Intensity Mode.

In order to change the Flux Set value, press the vertical menu button next to the Flux Set indicator. A red bullet icon on the left of the value currently established for Flux Set should appear on the front panel's interface. Then increase or decrease the Flux Set value to achieve the desired output intensity of the lamp.

Flux Mult- Flux Mult is short for Flux Multiplier. This allows for a user to increase or decrease the displayed Lamp Intensity by a proportional value from 0.01-9999.99.

Flux Multiplier is selected similarly to Flux Set as described above. Simply press the vertical menu button near the Flux Mult interface icon and observe a red bullet appear on the left of the current Flux Mult value. Then, use the knob to increase or the Flux Multiplier value as desired. The Lamp Intensity displayed on the LCD screen can be calculated by $\text{Lamp Intensity} = \text{Flux Set} \times \text{Flux Mult}$.

Be aware that varying the Flux Multiplier and thus the displayed Lamp Intensity does not change the power/current supplied to the lamp or its output intensity. This function simply changes the Lamp Intensity or μA reading on the LCD screen as requested by the user.

lidle- The lidle function allows a user to set the amount of current to be supplied to the lamp during idle mode operation. As implied by its name, this current will only be applied to the lamp when idle mode is turned on.

To change the lidle, press the vertical soft key menu button near the lidle interface icon and observe a red bullet appear on the left of the current lidle value. Then, use the knob to increase or the lidle value as desired. See page 27 of this manual to learn when Idle mode would be beneficial to use.

Imax- Imax is the maximum current to be supplied to the lamp during operation. This parameter is the same current limit that is selected by the user when operating in Constant Current Operation mode. This value will be determined by the Maximum Operating Current specification as defined by the user's lamp manufacturer.

Imax is set by press the vertical soft key menu button near the Imax interface icon. A red bullet will appear on the left of the current lidle value. The Imax parameter can then be increased/decrease by using the knob to the right of the vertical menu button.

Please note that changing the Imax while operating the lamp in Current Mode Operation also changes the Imax during Intensity Mode Operation. Before igniting the lamp in either Current Mode or Intensity Mode operation, the maximum specifications should be confirmed and preset by the user to avoid damage to the lamp.

8. The lamp can now be operated in Intensity Control Mode.

10.1 IDLE FUNCTION

The Idle function may be enabled when the lamp is in Intensity Mode. This function is useful in systems where the 71582 TE Cooled Si detector is not coupled to the lamp housing and located after the shutter relative the light path. In this type of setup, the 71852 is not exposed to any light when the shutter is closed. The detector output drops to zero μA until the shutter is opened.

The Idle function, when enabled, activates when the shutter is closed. Its purpose is to maintain the power supply settings that were in effect prior to the closing of the shutter. This ensures continuous, stable operation of the lamp regardless of the shutter status. Any sudden, drastic changes to the lamp's operating power or current requires time for the lamp to stabilize at its new set point.

When the shutter re-opens with the Idle function enabled, active monitoring of the light output level is resumed by the 71582. As long as no changes were made to the system setup while the shutter was closed, the intensity control set point should not be drastically different from the set point that was in effect before the shutter closed. The Idle function should therefore prevent large changes in light output, and avoid the need for additional lamp stabilization time.

When the Idle function is not enabled, the 71852 detector maintains continuous monitoring of the light level. If the 71582 detector is not located after the shutter in the light path, or if a shutter is not being used, the Idle function should not be enabled.

The Idle function should be set prior to beginning any exposures. It can be accessed through the System2 menu shown below. The default setting is the setting previously used by the user during previous operation.

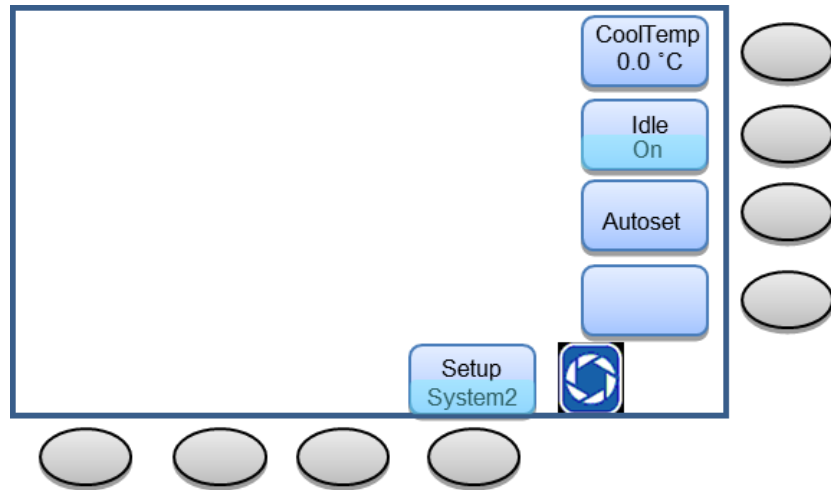

Figure 20 Idle Function Setup.

11 SHUTTER CONTROLLER

The OPS power supplies enable users to control a shutter that responds to a TTL signal. Users may control the shutter using a variety of methods.

Manual mode	A front panel button toggles the shutter open or closed.
Timed mode	The shutter open time, close time, and number of cycles are set by the user.
Dose mode	The dose, close time and number of cycles are set by the user.
External TTL control	The shutter opens or closes based on an external TTL low or high signal.
External TTL trigger	The shutter begins a preset time or dose routine when triggered by a TTL signal going from high to low.
Remote switch trigger	Closing or opening a user-supplied switch, such as a foot pedal or remote push button, controls the shutter.



WARNING

The use of incorrect TTL shutter settings may cause the shutter to open up at an unexpected time. This may result in injury to persons and/or damage to property. Take all necessary precautions against UV light exposure until one is certain the system is behaving as expected.

11.1 SHUTTER STATUS

The shutter status is indicated on the power supply display at all times. If a shutter is not being used in the system, by default it will appear as closed on the display.

Note: the power supply does not receive feedback from the shutter as to whether it is functioning correctly. The shutter status indicator is based on the signal being sent from the power supply's Shutter Output connector.

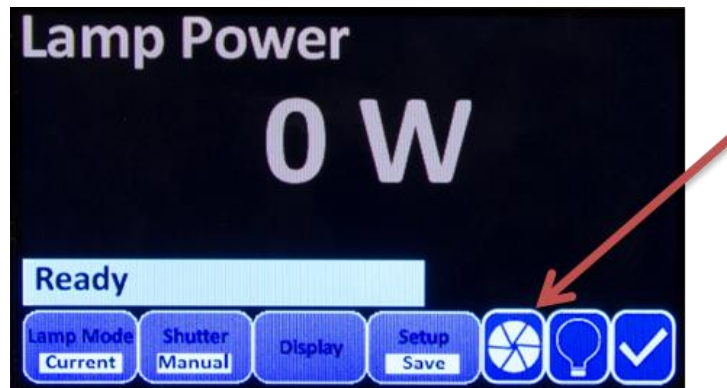

Figure 21 Shutter Status Indicator on Display.

The System1 setup menu provides the means to indicate of the shutter will open or close based on the input of a TTL high or low signal from the Trigger Input connector on the back of the power supply.

If the shutter status symbol on the power supply display indicates the opposite condition with respect to the actual shutter status while using external TTL control, this setting needs to be modified. Refer to the Section in this user's manual regarding External Shutter Control Methods for more information.



Figure 22 Shutter Status Symbols.

11.2 MANUAL SHUTTER MODE

This feature is available when the shutter is set to Manual. The lamp mode may be set to Power, Current or Intensity mode.

To operate the Shutter in Manual mode, press the horizontal menu key under the Shutter icon on the LCD screen until Manual operation mode is listed as shown:

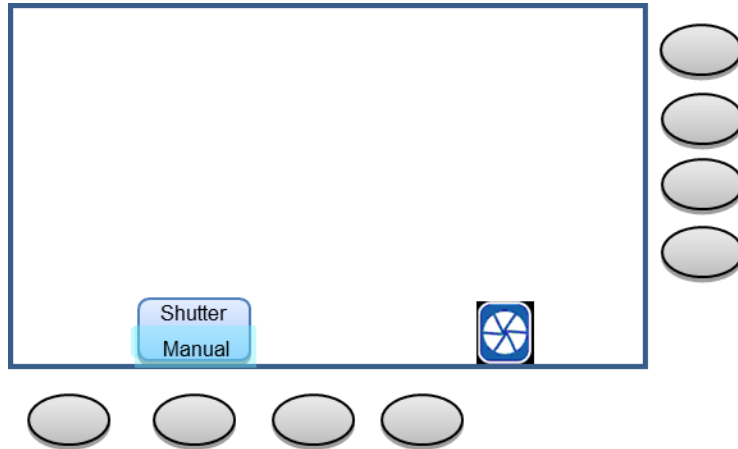

Figure 23 Manual Shutter Mode (Shutter Closed).

To toggle the shutter open or closed, press the button labeled SHUTTER on the front face of the power supply.



Figure 24 Manual Shutter Button.

11.3 TTL SHUTTER CONNECTION

Any shutter that can be driven by a TTL signal may be controlled by the OPS power supply. Connect the shutter to the BNC female connector on the back of the power supply labeled "SHUTTER OUTPUT". This connector is shown in Figure 22.



Figure 25 Shutter Output Connector.

11.4 TTL SIGNAL POLARITY

The settings of the OPS-A Model Power Supply can be adjusted to output both positively and negatively biased TTL pulses depending on the requirements of the external shutter being used. To adjust this TTL signal output polarity, access the System 1 setup menu as shown below:

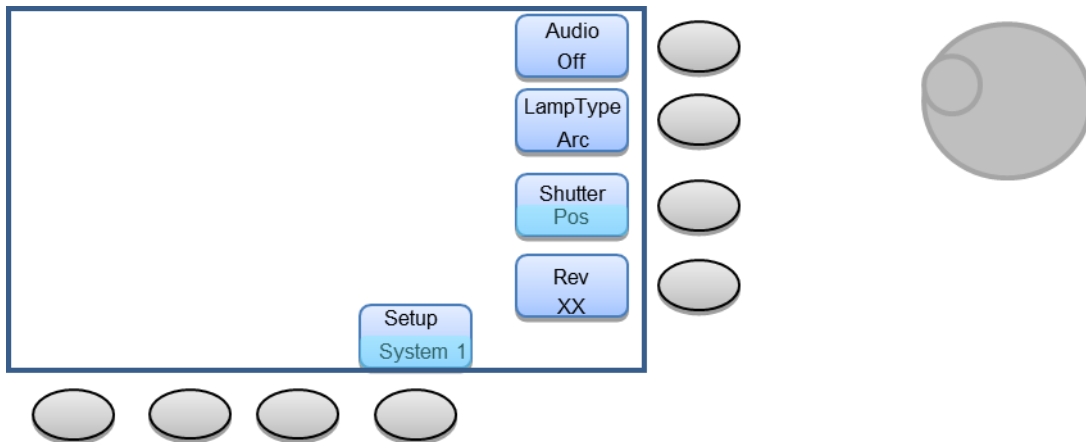

Press the vertical menu button next to the Shutter indicator. When a red bullet appears next to the current Shutter setting, use the knob to adjust to Pos or Neg as required by the external shutter.

Be aware that selecting the wrong TTL polarity as required for the shutter will cause the shutter status indicators described in **11.1 Shutter Status** to indicate the wrong open/closed status. Damage to the external shutter may occur as well from inputting opposite polarity TTL signals than the shutter was designed for.

11.5 TIMED SHUTTER MODE

Timed Shutter Mode is useful for applications in which the area being irradiated needs to be irradiated repeatedly with precise timing intervals rather than continuously exposed to light until the lamp is turned off. This feature is available when the lamp is being operated in Power, Current and Intensity Modes.

1. To operate the shutter in Timed Shutter Mode, press the horizontal menu key under the Shutter indicator until Timed appears under the Shutter indicator and the corresponding vertical menu as shown below appears:

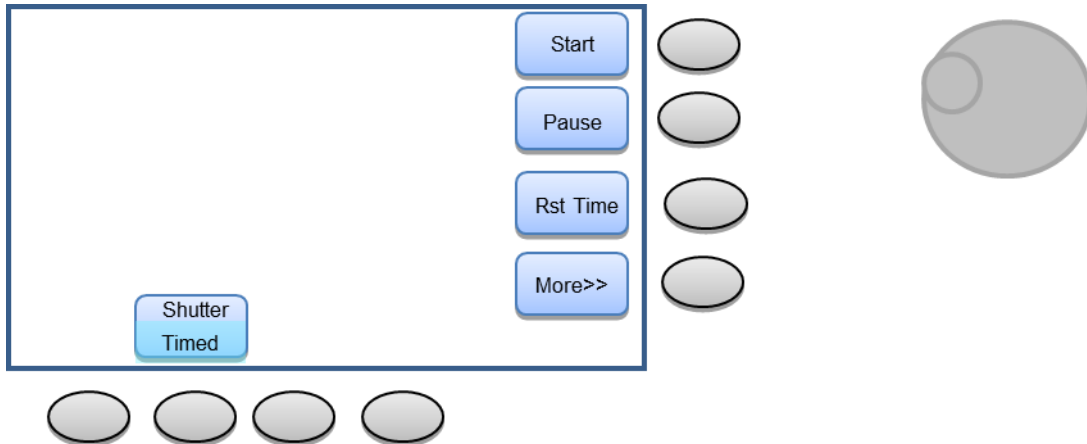

2. To set the Open, Close, and number of cycles for the shutter to operate, Press the vertical menu key next to the More>> icon. The vertical menu as shown on the next page will appear on screen:

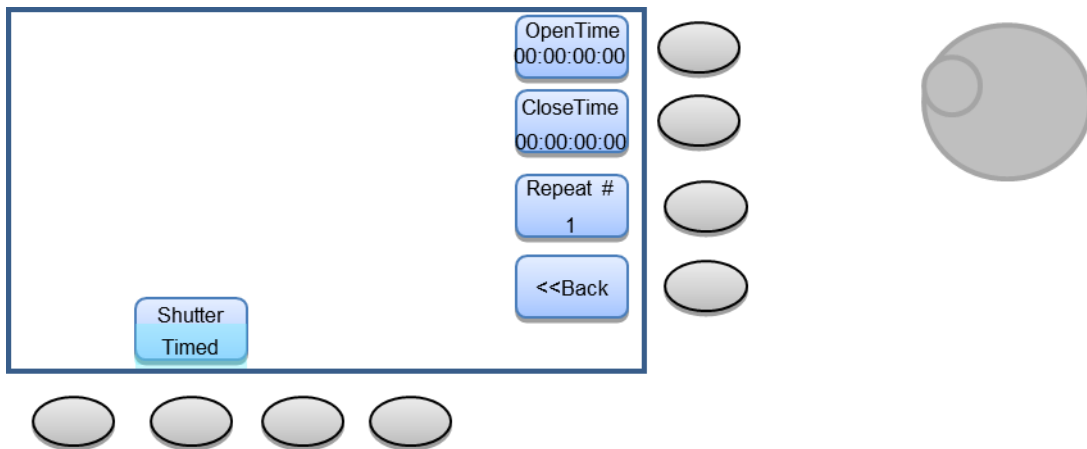

Set the following parameters as required for the application:

Open Time

Pressing this button allows the user to change the length of time the shutter is open. The format is hh:mm:hh.th. The default open time is 1 second and may be set from 10 ms to 99.99 hours. To adjust the Open Time, when press the vertical menu key next to this indicator until the increment of time to be adjusted flashes. Then use the external knob to increase or decrease the timing value as required.

Close Time

This button changes the length of time the shutter is closed between the exposures when **Repeat #** is set to greater than 1 cycle. The format is hh:mm:hh.th. The default close time is 1 second and

may be set from 10 ms to 99.99 hours. To adjust the Close Time, when press the vertical menu key next to this indicator until the increment of time to be adjusted flashes. Then use the external knob to increase or decrease the timing value as required.

Repeat #

This button allows users to set the number of times an exposure repeats. The default is 1 cycle. To adjust the Repeat#, press the vertical menu key next to this indicator. When a red bullet appears next to the current Repeat# setting, use the external knob to increase or decrease this value as required.

<<Back

Pressing this button displays the previous vertical menu choices.

3. Press the vertical menu button next to the **<<Back** indicator to bring back the first menu shown on the previous page.

When the shutter is operated in Timed Exposure Mode, new display options are available. Pressing the horizontal menu key under the Display indicator on the LCD screen shows that Open Time, Close Time, Cycle Number, and Total Time are now available display options. Total Time is the total amount of time the shutter has spent in the Open position, throughout all exposure periods performed by the Power Supply.

4. When ready to begin operating in Timed Shutter Mode, Ignite the lamp in Power, Current, and Intensity Mode as desired. The "Function Not Available" error message appears on the LCD screen if the lamp is not ignited first. Press Start to begin the first exposure.

Start/Stop/Continue

This button starts or stops a dosed exposure, or continues a paused exposure. Once the exposure starts and in progress, the button will display *Stop*. When the exposure is paused, the button will display **Continue**. When the exposure finishes or has been stopped, it will display *Start* in anticipation of the next exposure to be performed.

Pause

Pressing this button pauses an ongoing dosed exposure. Pressing the **Continue** button will allow the exposure to resume. This button functions only when an exposure is in progress.

Rst Time

This button resets the Total Time to 0s. Be aware that Total Time cannot be reset during an exposure or while an exposure is paused. An exposure cycle must be completed, or Stop must be pressed in order to reset the Total Time.

More>>

Pressing this button displays a new set of vertical buttons for parameters related to time control as described in Step 2.

11.6 DOSED SHUTTER MODE

Dosed Shutter Mode is available when the lamp is being operated in Intensity Mode. This function is used when the irradiated area needs to be irradiated in precise, repeated timing intervals, but with precise light intensity output as well.

1. To use Dosed Shutter Mode, begin operating the lamp in Intensity Control Mode. Set the Flux Set, Flux Multiplier, Idle, and I_{max} parameters as necessary/required.
2. Press the horizontal menu key under the Shutter indicator until Dosed appears in the indicator with the corresponding vertical menu as shown below:

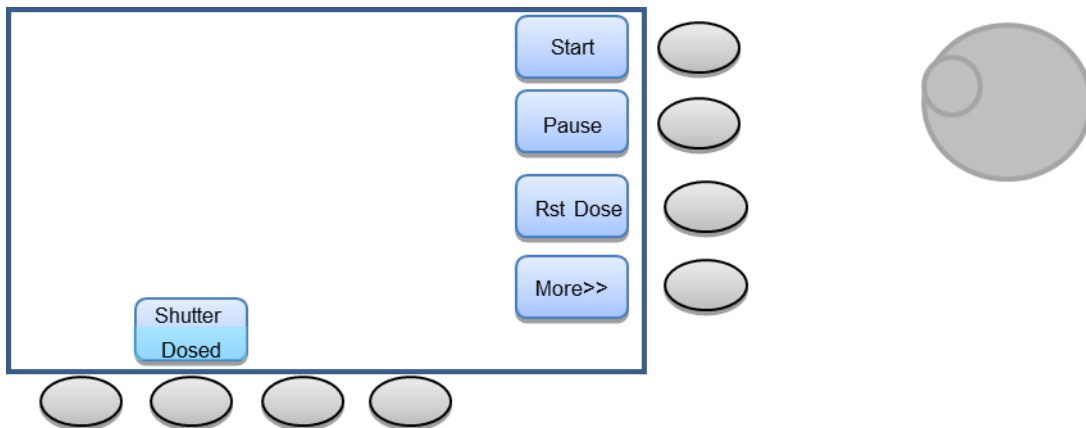

3. Press the vertical menu key next to the More>> indicator to access the vertical menu shown on the next page:

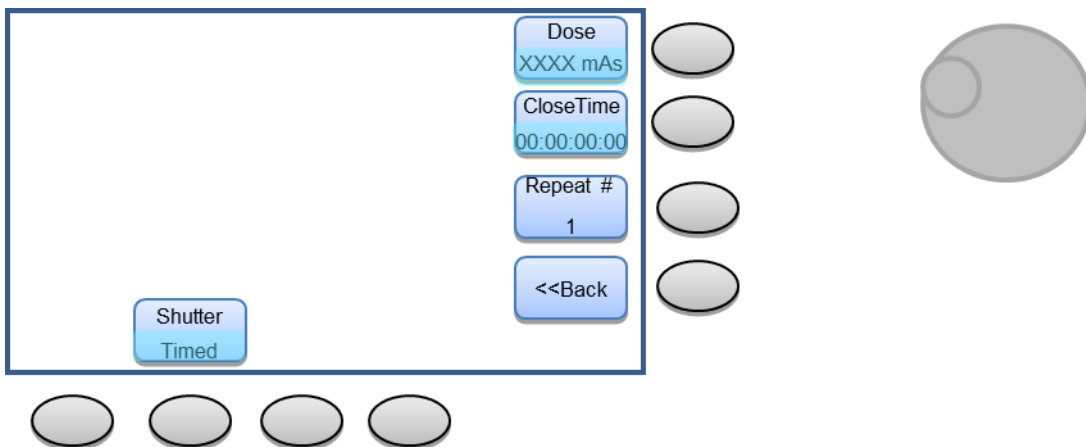

Dose

Pressing this button allows the user to change the displayed Dose for the exposure. Dose consists of a Flux and a time interval. When the Dose is set by the user, the power supply controls the shutter to remain open for the time interval required for the lamp to output the selected Dose value based upon the Flux value set in Intensity Mode. To adjust the Dose value, press the vertical menu key next to the indicator on the LCD screen. When a red bullet appears next to the current setting, use the external knob to adjust the Dose value as required. The default dose is the Dose value previously set by the user and may be set from 0.01 to 9999.99 mAs.

Close Time

This button changes the length of time the shutter is closed between the exposures when **Repeat #** is set to greater than 1 cycle. The format is hh:mm:hh.th. The default close time is 1 second and may be set from 10 ms to 99.99 hours. To adjust the Close Time, when press the vertical menu

key next to this indicator until the increment of time to be adjusted flashes. Then use the external knob to increase or decrease the timing value as required.

Repeat #

This button allows users to set the number of times an exposure repeats. The default is 1 cycle. When a red bullet appears next to the current Repeat# setting, use the external knob to increase or decrease this value as required.

<<Back

Pressing this button displays the previous vertical menu choices.

When the shutter is operated in Dosed Exposure Mode, new display options are available. Pressing the horizontal menu key under the Display indicator on the LCD screen shows that Dose and Total Dose are now available display options. Total Dose is the accumulated Dose the lamp has been allowed to irradiate light onto the irradiation area over multiple cycles.

4. Press the **<<Back** button to return to the original vertical menu as shown in the previous page.
5. When ready to begin operating in Timed Shutter Mode, Ignite the lamp in Power, Current, and Intensity Mode as desired. The “Function Not Available” error message appear on the LCD screen if the lamp is not ignited first. Press Start to begin the first exposure.

Start/Stop/Continue

This button starts or stops a dosed exposure, or continues a paused exposure. Once the exposure starts and in progress, the button will display *Stop*. When the exposure is paused, the button will display *Continue*. When the exposure finishes or has been stopped, it will display *Start* in anticipation of the next exposure to be performed.

Pause

Pressing this button pauses an ongoing dosed exposure. Pressing the *Continue* button will allow the exposure to resume. This button functions only when an exposure is in progress.

Rst Dose

This button resets the total exposure dose to 0 mA or 0 μ A. Be aware that Total Dose cannot be reset during an exposure or while an exposure is paused. An exposure cycle must be completed, or Stop must be pressed in order to reset the Total Dose.

More>>

Pressing this button displays a new set of vertical buttons for parameters related to time control.

11.7 EXTERNAL SHUTTER CONTROL METHODS

The BNC connector labeled “TRIGGER INPUT” on the rear panel may be used to remotely control the operation of a shutter that is connected to the power supply. A TTL signal may be applied to the Trigger Input connector, or a remote switch closure may be wired to the connector.

If the shutter function is set to timed mode and a TTL signal is sent to the Trigger Input connector, the first falling edge (high to low) triggers the start timed exposure cycle.

The Low pulse must be at least 70 milliseconds long to trigger the cycle. The timed cycle then runs to its conclusion and disregards any additional signals received at the Trigger Input connector while the cycle is in progress.

If the shutter is set to manual mode and a TTL signal is sent to the Trigger Input connector, the shutter remains open for the duration of the Low signal.

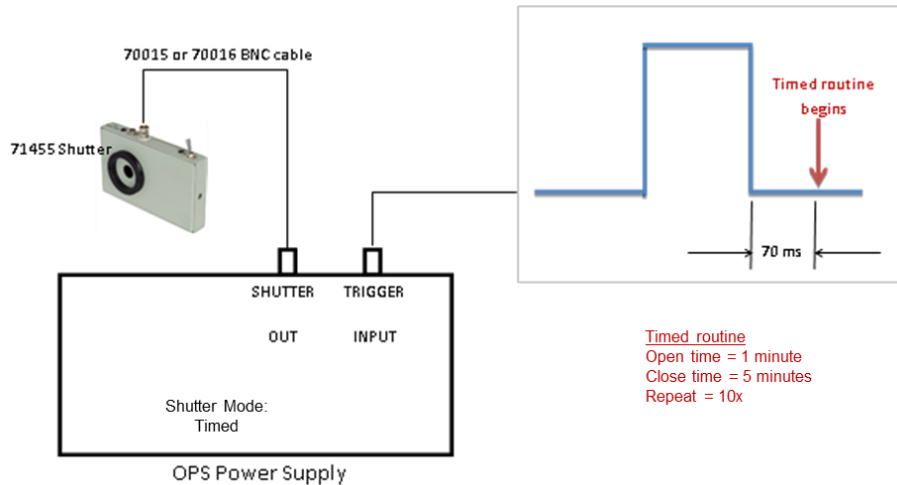



Figure 26 Trigger Example.

By default, the shutter opens when a TTL Low signal is sent through the Trigger Input connector. The power supply setup may be changed to allow an external TTL High signal to open the shutter. Changing this setting is done through the System1 menu, as explained in **11.4 TTL SIGNAL POLARITY** of this manual.

To avoid unexpected shutter behavior, this setting should be changed only when the shutter is closed and no signal is being applied at the Trigger Input connector.

Note: If unsure of the correct TTL setting/shutter compatibility, the user should take all necessary precautions against light exposure until the correct TTL setting/shutter compatibility has been confirmed and the system is behaving as expected.

	<p>WARNING</p> <p>The use of incorrect TTL shutter settings may cause the shutter to open up at an unexpected time. This may result in injury to persons and/or damage to property. Take all necessary precautions against UV light exposure until one is certain the system is behaving as expected.</p>
---	--

12 AUDIO WARNING

An audio buzzer is designed into the OPS power supply. This buzzer is used to provide an alert in the event of the power supply being unable to maintain intensity control of the system. The audio buzzer, if enabled, functions when the power supply is in Intensity mode.

The following conditions will cause an audible buzzer with the corresponding error message:

Error Message	Condition
Interlock Open	Lamp housing connection cable became loose or lamp housing door were opened when the lamp was ignited
Ignition Failed	Ignition failure during operation of the lamp. A very low current draw from the lamp was detected
Heatsink Over Temp	The internal temperature of the power supply's heat sink became too high for safe operation.

It is recommended to follow the advised actions in the Troubleshooting Section of this manual for each error message if the audio alarm is heard.

In addition to an audio warning, a warning icon also appears on the power supply's display, as shown below.



Figure 27 Warning Icon.

12.1 AUDIO WARNING SETUP

The audio warning buzzer may be enabled or disabled according to the user's preferences. If the buzzer is disabled, the only indication of an error will be the warning icon shown on the OPS power supply display. Changing this setting is done through the System1 menu, as shown on the next below.

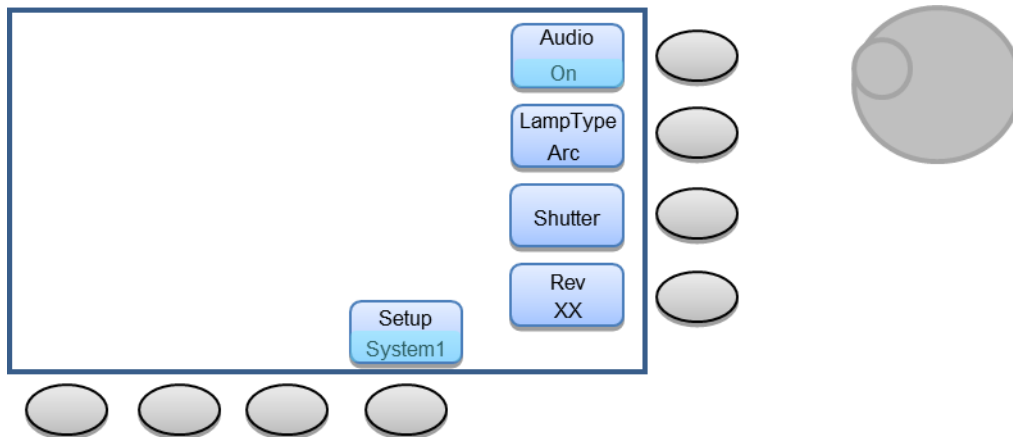

Figure 28 Audio Warning Setup.

1. Press the horizontal menu button under the Setup indicator until System 1 appears with the corresponding vertical menu as shown on the previous page.
2. Press the vertical menu button next to the Audio indicator. When a red bullet appears next to the current setting, use the external knob to change this setting.

3. When done, press the CLEAR button to clear the menu from the screen.

13 MEMORY

The OPS power supply automatically retains the last settings that were in effect prior to powering down the unit. When the unit is powered up again, these settings are automatically loaded.

Because of the versatility of the OPS power supplies, Oriel recognizes that this unit may be utilized in a wide variety of projects. Therefore, the power supply was designed to allow up to four Setups to be saved into memory.

The last used settings of the following parameters are reverted to upon powering on the power supply:

- Lamp Operating Mode (Power, Current, Intensity)
- Operating Power and Current (Pset/Iset)
- Maximum Operating Power and Current (Pmax/Imax)
- Flux Set
- Flux Multiplier (Flux Mult)
- Idle current and Maximum Current in Intensity Mode (Iidle, Imax)
- Alarm Audio (On/Off)
- Shutter TTL (Pos/Neg)
- Detector Cooler Temperature (CoolTemp)
- Shutter Mode (Manual, Timed, Dosed)
- Shutter Open/Close Time (for Timed Shutter Mode)
- Repeat Cycle#
- Dose
- Close Time (for Dosed Shutter Mode)
- Repeat Cycle#
- Total Time, Total Dose

14 SAVING SETTINGS

Selecting one of the Setups allows the current parameters to be saved into memory.

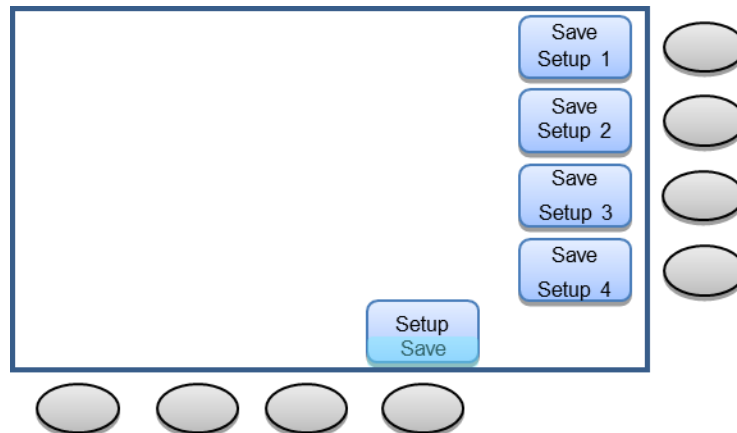

Figure 29 Saving Settings To Memory.

To save settings press the horizontal menu button under the Setup indicator on the LCD screen until Save appears under the Setup icon as shown above. Select one of the four available Setup spaces to store the current operating and press the vertical menu button next to that Setup space. The settings the power supply is currently operating under are now saved under the selected Setup space.

The following parameters are saved when a Setup is saved:

- Lamp Operating Mode (Power, Current, Intensity)
- Operating Power and Current (Pset/Iset)
- Maximum Operating Power and Current (Pmax/Imax)
- Flux Set
- Flux Multiplier (Flux Mult)
- Idle current and Maximum Current in Intensity Mode (Iidle, Imax)
- Alarm Audio (On/Off)
- Shutter TTL (Pos/Neg)
- Detector Cooler Temperature (CoolTemp)
- Shutter Mode (Manual, Timed, Dosed)
- Shutter Open/Close Time (for Timed Shutter Mode)
- Repeat Cycle#
- Dose
- Close Time (for Dosed Shutter Mode)
- Repeat Cycle#
- Total Time, Total Dose

14.1 LOADING SETTINGS

Selecting one of the Setups allows previously saved parameters to be loaded from memory.

It is always suggested to navigate through the settings to verify the correct Setup was retrieved prior to starting the lamp.



CAUTION

The use of inappropriate lamp operating power or current may result in damage to the lamp and/or lamp housing.



WARNING

The use of incorrect TTL shutter settings may cause the shutter to open up at an unexpected time. This may result in injury to persons and/or damage to property.

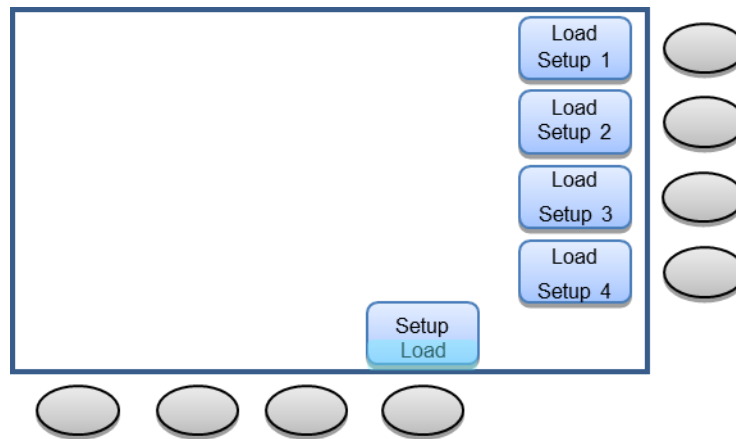

Figure 30 Loading Saved Settings From Memory.

Loading a previously saved Setup is very similar to the method used to save that Setup. Press the horizontal menu button under the Setup indicator until Load appears under Setup as shown above. Press the vertical menu button next to the Setup space the desired settings were saved under. The settings of the previously saved Setup have now been recalled.

15 MAINTENANCE

15.1 POWER SUPPLY CLEANING

Clean the exterior of the OPS when it is not hot from use. Use a clean, dry cloth. Ensure that the ventilation holes are not blocked with dust. Vacuum the openings, if necessary, from the outside of the unit. Ensure the power supply is unplugged from the electrical mains prior to cleaning.

15.2 LAMP CARE AND HANDLING

Do not allow any contaminants or fingerprints to adhere to the lamp envelope or reflector. Always wear powder-free gloves when handling lamps. Handle the lamp by holding the outside of the reflector only. If a lamp becomes contaminated, do not use it before cleaning its envelope with isopropyl alcohol. Dry completely before using.

	<p>WARNING</p> <p>Failing to reset the lamp hours after lamp replacement will make it difficult to track the amount of time the new lamp is in use. A lamp used past its rated life may deteriorate rapidly in performance or burst.</p>
---	---

If contaminants are not removed, it may lead to reduced light output, overheating, damage to the envelope and premature failure. The lamp's reflector is coated and should not be wiped or touched at all. Remove any particulates such as dust using a bulb blower.

16 LAMP LIFETIME AND REPLACEMENT

The anode and cathode of an arc lamp are made of tungsten. The cathode is small and pointed to ensure that the tip reaches a high temperature for efficient electronic emission. The anode is more massive to withstand the electron bombardment and efficiently dissipate the heat produced. Mercury arc lamps have coils on one or both electrodes to help in arc formation. The anode-cathode gap depends on the lamp design, and is directly related to the operating voltage of the lamp.

The tungsten from the electrodes evaporates slowly with use, and deposits on the inside of the lamp envelope. This reduces the radiated output. Towards the end of the lamp's life, UV output is reduced. Also, electrode burn back opens the anode-cathode gap further which in turn changes the operating voltage of the lamp.

Oriel quotes typical lamp life for each lamp. This is the average period for the visible output to fall to 75% of the initial value. It is based on running the lamp for 30 minutes between ignitions. There can be significant tungsten removal from the cathode during ignitions, so frequent starts will reduce lamp life.

	<p>WARNING</p> <p>It is strongly suggested to replace any arc lamp after the rated life to avoid rapid deterioration in output and bursting in a potential dramatic lamp failure.</p>
--	--

To assist users with determining the age of their lamps, Oriel designed the OPS power supplies with a counter that tracks the amount of time the lamp is powered on. It is suggested to reset the lamp hours whenever a lamp is replaced. The lamp hours should be periodically monitored, to ensure the lamp is not used past its rated lifetime and a replacement lamp is ordered. This helps to prevent an unexpected lamp failure, with its resulting down-time and possible damage to the lamp housing.



Figure 31 Arc Lamp Construction.

17 DISPLAYING TOTAL LAMP HOURS

Press the button underneath “Display” on the front panel. Use the scroll wheel on the power supply until Lamp Hours is selected. Press the Display or CLEAR button in order to view the number of hours the lamp has been turned on.

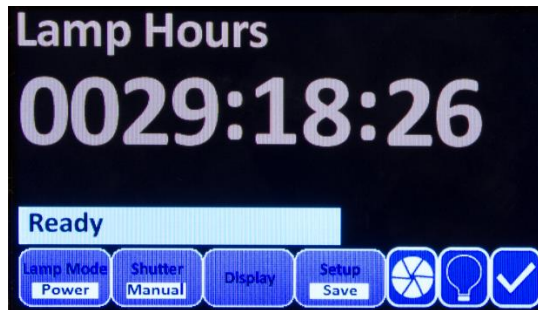
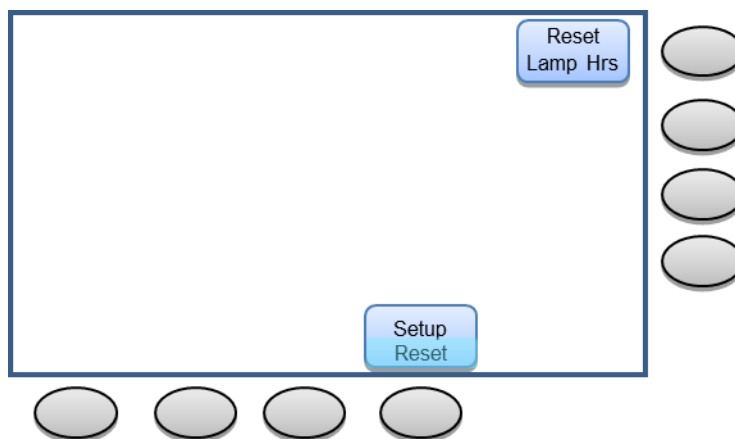

Figure 32 Displaying Lamp Hours.

17.1 RESETTING TOTAL LAMP HOURS

Press the horizontal menu button under the Setup indicator on the front display until the Reset menu is displayed, as shown below. Click the Lamp Hrs button in order to reset the total number of hours.



The lamp hours can only be reset when the lamp is not ignited. The Reset Lamp Hours feature was integrated into the power supply to allow a user to monitor lamp lifetime from installation or its first usage.

If necessary, the monitoring of any time interval while the lamp is ignited can be done with the use of an external shutter and the Display settings.

18 OPS-A SERIES OVERVIEW

	OPS-A150	OPS-A500	OPS-A1000
Approved Lamp Wattage	50 – 150 W	200 – 500 W	450 – 1000 W
Power Factor	>0.99		
Input Voltage	95 – 264 VAC		
Input Current Max	3 A	7 A	13 A
Input Frequency	47 – 63 Hz		
Output Current Range	1.5 – 10 A	3 – 24 A	17.5 – 55 A
Output Voltage Range	0 – 45 VDC	0 – 100 VDC	0 – 45 VDC
Line Regulation	0.01%		
Output Voltage Ripple	< 0.1 % rms	< 1.0 % rms	< 0.1 % rms
Light Ripple	< 0.5 % rms	< 1 % rms	
Meter Accuracy (% of full scale)	<0.05 %		
Digital Meter Resolution, Voltage	0.01 VDC		
Digital Meter Resolution, Power	1 W		
Digital Meter Resolution, Current	0.01 A		
Safety Interlock Voltage	12 VDC/GND		
Operating Mode	Constant Current, Power, or Intensity		
Operating Temperature	10 – 45 °C		
Max Relative Humidity	80%		
Max Weight lb (kg)	12 (6)		
Max Dimensions (W x D x H) in.	12.0 x 16.25 x 4.25		
Shutter Control Resolution	10 ms		
Min Shutter Exposure Time			
Intensity Control Range (µA)	1 – 2450		
Intensity Control Resolution (µA)	1		
Intensity Multiplier (gain)	0.01 – 9999.99		
Dose Control Range (mA)	0.01 – 9.999 x 10 ¹²		
Dose Control Resolution (mA)	0.01		

Time Control Range	0.01 s – 99.99 hr
Time Control Resolution (s)	0.01
Lamp Hours Used Display Range	1 s – 9999.99 hr
Lamp Recording Resolution (s)	1
Temperature Control Range when using LIK-LMP	0 – 25 °C
Compliance	CE and RoHS

19 TROUBLESHOOTING

This chart provides the basic troubleshooting information for the Newport Model OPS power supplies when used with Newport lamp housing. Contact a Newport sales engineer or your local representative if more information is required.

Symptom	Action
Power supply does not turn on, e.g. <ul style="list-style-type: none"> • Fan not turning • Display does not turn on 	Check <ul style="list-style-type: none"> • AC power cable is properly connected to AC INPUT terminal • AC Main Power switch is switched to the ON position • AC power at wall outlet
Fault light <ul style="list-style-type: none"> • Display shows “Interlock Open” 	Turn off AC power and Check <ul style="list-style-type: none"> • Lamp interconnection connection cable(s) are firmly fixed to connectors on power supply and lamp housing • Door to lamp housing is closed • If the lamp was running before this error message appeared and the cooling fan of the lamp housing was operational, this indicates too high a temperature inside the lamp housing. Confirm there is no blockage of the cooling fan or vents of the lamp housing.

<p>Fault light</p> <ul style="list-style-type: none"> • Display shows “Ignition Failed” • Ticking sound heard from top of lamp housing during ignition cycle approximately once per second 	<p>This message is displayed usually when trying to ignite and ignition fails. It is a result of no current flow from supply after 5 second of trying to ignite the lamp.</p> <ul style="list-style-type: none"> • Turn off the power supply and disconnect the Lamp Interconnection Cable(s) between the lamp housing and the power supply. • Check lamp connection and polarity inside the lamp housing. A lamp installed upside down or with reversed polarity should be removed and replaced immediately. • Reconnect the Lamp Ignition Cable(s) between the lamp housing and power supply. Turn on the power supply. Re-attempt lamp ignition. • Confirm the hours of usage on the lamp. A lamp approaching the end of its rated lifetime will be difficult to ignite. • Attempt ignition with a new lamp. • If fault repeats contact Newport for RMA information.
<p>Shutter icon indicates the opposite of its actual status with external shutter TTL control.</p>	<p>In the System1 setup menu, change the Shutter setting to reflect the required TTL signal polarity.</p>
<p>Fault light</p> <ul style="list-style-type: none"> • Display shows “Cooler Not Ready” 	<p>This message is displayed when the 70062 cable is not securely connected to the power supply and/or 71582, or the power supply is attempting to change the operating temperature of the detector to a temperature not possible due to external conditions.</p> <ul style="list-style-type: none"> • Inspect the connections of the 70062 cable at the rear of the power supply and 71582 TE cooled detector to ensure the connections are securely in place. • Increase/decrease the CoolTemp setting in the System 2 menu as necessary until a temperature possible with external conditions is obtained.
<p>Fault light Display shows “Heatsink Overtemp”</p>	<p>This message is displayed when the heatsink temperature sensor reading inside the power supply has exceeded 90 °C.</p> <ul style="list-style-type: none"> • Cycle power to the power supply • If fault repeats contact Newport for RMA information.
<p>Fault light Display shows “Power Supply Failed”</p>	<p>This message is displayed when the power supply cannot be enabled for the lamp or there is a short in the Lamp Housing Interconnection Cable.</p> <ul style="list-style-type: none"> • Turn off the power supply and replace the Lamp Housing Interconnection Cable with one confirmed to be working. • If fault repeats contact Newport for RMA information

<p>Fault light Display shows "Change Shutter Mode 1st"</p>	<p>This message will flash for 2 seconds if the user tries to change the Lamp Mode from Intensity Mode to another mode while the Shutter Mode is in Dosed Mode.</p> <ul style="list-style-type: none">• Change the Shutter Mode to Manual or Timed Mode first, then change the Lamp Mode.
<p>Fault light Display shows "Function Not Available"</p>	<p>This message will flash for 2 seconds if the user presses the Start or Pause button when the lamp is not ignited while operating in Timed or Dosed Shutter Mode or presses the Pause button when the lamp is ignited but no Timed or Dose Mode shutter sequence is running.</p>

<p>Fault light</p> <ul style="list-style-type: none">• Display shows “Autoset Fail” when attempting to obtain Autoset parameters for lamp intensity when operating in Power or Current operating modes.	<p>The following conditions will cause the Autoset Fail error message to display:</p> <ul style="list-style-type: none">• Cooler is not ready (most likely is caused by the cooler cable not connected).• Lamp is not on.• No flux signal or saturated flux signal, causing the flux signal to be out of range of 50uA to 2500uA. <p>The following corrective actions are recommended:</p> <ol style="list-style-type: none">1. Follow the steps in the Action procedure for Display shows “Cooler Not Ready” as described above.2. Confirm if lamp is ignited when Autoset button is pushed.3. Press the CLEAR button to clear the error message.4. If the lamp is not currently ignited, ignite the lamp and attempt to Autoset again. <p>If the Power Supply fails to Autoset, the flux reading of the LIK-LMP’s 71582 detector head out of the recordable range of the power supply.</p> <ol style="list-style-type: none">1. If the 71582 detector head is directly connected to lamp housing switch to the other Disk with Aperture included with the LIK-LMP.2. If the 71582 detector head is external from the lamp housing, adjust the position of the detector head (distance from light source, filtering if applicable, etc.) to make the flux output within range of the power supply. <p>If using RS232 or USB method of external control, the command “FAULT?” can be used to determine the cause of Autoset failure. Each corresponding bit, when set, indicates the corresponding fault:</p> <ul style="list-style-type: none">• Bit3: Cooler is not ready (most likely is caused by the cooler cable not connected).• Bit9: Lamp is not on.• Bit4: No flux signal (Flux reading is less than 0.2uA even at the highest gain of 1000).• Bit5: Saturated flux signal (Flux reading is at full scale even at lowest gain of 1).• Bit2: Flux signal is out of range of 50uA to 2500uA. <p>Using the FAULT? command will allow the user to determine the cause of Autoset failure more efficiently.</p>
---	--

EU DECLARATION OF CONFORMITY

We declare that the products, identified with the **CE** mark, comply with requirements of the Directive, 2014/30/EU and Directive 2006/95/EC.

Manufacturer's name: Newport Corporation
Manufacturer's address: 1791 Deere Avenue
Irvine CA 92606 USA
Declares that the product:
Product Name: Optical Power Supply
Model Numbers: OPS-A150
OPS-A500
OPS-A1000
Type of equipment: Electrical equipment for measurement, control and laboratory use in industrial locations

conforms to the following Product Specifications:

Safety: EN 61010-1:2010
EMC: EN 61326-1:2013

complies with the following Directives:

EMC Directive 2004/108/EC
Low Voltage Directive 2006/95/EC

and accordingly, carries the **CE mark**

CE mark affixed:

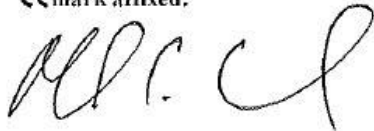

02/06/2015

Mark Carroll

VP, Instruments Business

Newport Corporation

1791 Deere Ave, Irvine, CA 92606 USA

APPENDIX A: COMPUTER CONTROL

The power supply may be manually controlled using the front panel, or it may interface to a PC using a USB or RS232 connection.

- Pin 1 Not used.
- Pin 2 TX.
- Pin 3 RX.
- Pin 4 Not used.
- Pin 5 GND.
- Pin 6 Not used.
- Pin 7 Not used.
- Pin 8 Not used.
- Pin 9 Not used.

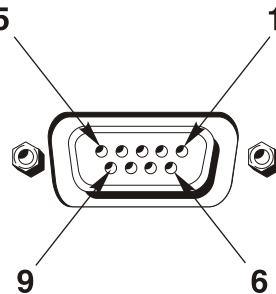

Figure 33 RS232 Connector

Serial Port Setup:

9600 Baud, 8 bits, 1 Stop, No Parity, No Flow Control

Syntax:

ASCII Text

Received command lines are to be terminated by CR

Transmitted responses are terminated by CR/LF

Parameters separated by a space or "="

Parameter and Response Types and Format:

ASCII strings representing:

fp : Floating Point : fff.ff or ff.f

i : Integer : iii

c : Character : c

t : Time : hhh:mm:sec.th

Sample command: EXPMODE T sets exposure mode to AUTO-TIME

COMMAND SET

Command String	Parameter	Response	Description
STB?	none	STBXX (HEX) Bit 3 - Fault Bit 0 - Interlock	A response of '9' indicates that both bit 0 and 3 are set. Indicating that the unit is in fault and the interlock is open.
ESR?	none	ESRXX (HEX) Bit 5 - Command Error Bit 0 - Operation Complete	A response of '64' indicates that the unit did not understand the command. A response of '1' indicates that the prior command has been processed.
AMPS?	none	ff.f	Lamp current in A
VOLTS?	none	fff.f	Lamp voltage in V
WATTS?	none	iiii	Lamp power in W
LAMP HRS?	none	iiii	Accumulated lamp on time in hours
A-PRESET?	none	ff.f	Lamp current preset value in A
P-PRESET?	none	iiii	Lamp power preset value in W
A-LIM?	none	ff.f	Lamp current limit value in A
P-LIM?	none	iiii	Lamp power limit value

			in W
IDN?	none	c	Power supply model: A: Model A B: Model B C: Model C D: Model D E: Model E
START	none	ESRXX (See ESR command for Hex value definition)	Start the lamp
STOP	none	ESRXX (See ESR command for Hex value definition)	Stop the lamp
RST	none	ESRXX (See ESR command for Hex value definition)	Reset power supply to factory default
RSTHRS	none	ESRXX (See ESR command for Hex value definition)	Reset lamp hours to 0
MODE	i i = 0: Power mode i = 1: Current mode	ESRXX (See ESR command for Hex value definition)	Set lamp mode
COMM	i i = 0: front panel unlock i = 1: front panel lockout	ESRXX (See ESR command for Hex value definition)	Lockout/unlock front panel keys
SAVE	i i = 1-4, memory location 1-4	ESRXX (See ESR command for Hex value definition)	Save operation parameters to location specified
RECALL	i i = 1-4, memory location 1-4	ESRXX (See ESR command for Hex value definition)	Load operation parameters from location specified
A-PRESET	ff.f	ESRXX (See ESR	Set PRESET current

		command for Hex value definition)	value if < current limit (A-LIM); else returns ESR error bit 5 (Command Error)
P-PRESET	iii	ESRXX (See ESR command for Hex value definition)	Set PRESET power value if < power limit (P-LIM); else returns ESR error bit 5 (Command Error)
A-LIM	ff.f	ESRXX (See ESR command for Hex value definition)	Set current limit when lamp is off
P-LIM	iii	ESRXX (See ESR command for Hex value definition)	Set power limit when lamp is off
STARTEXP	none	0 for success	Starts exposure r running
STOPEXP	none	0 for success	Stops exposure running
PAUSE	none	0 for success	Pauses exposure
EXPSTATE?	none	O= running open cycle P = paused C= running close cycle S = stopped	Queries the present exposure state
RUN?	none	1 = Exposure is running 0 = Exposure is stopped	Queries the exposure running status
EXPMODE?	none	T = Auto timed D= Auto Dose M = Manual	Queries Exposure Mode
EXPMODE	T, D or M	0 for success	Sets Exposure mode, see query above
SHUTTER?	none	1 = Activated (Open) 0 = Deactivated (Closed)	Queries the shutter state.

EXPDOSE?	none	fff.ff	Queries the present dosage for a running exposure
DOSE	fff.ff	0 for success	Sets dosage to run each exposure cycle for.
DOSE?	none	fff.ff	Queries the dosage for exposures cycles
TOTALDOSE?	none	ffff.ff	The total accumulated lifetime dosage
CLRTOTALDOSE	none	0 for success	Clears total dosage
CLRTOTALTIME	none	0 for success	Clear total time of exposure
TOTALTIME?	none	hhhh:mm:ss.th	Queries the total accumulates open exposure time
OPENTIME?	none	hh:mm:ss.th	Queries the open time for exposures cycles
OPENTIME	hh:mm:ss.th	0 for success	Sets the open time for exposures cycles
EXPOPEN?	none	hh:mm:ss.th	Queries present open time for a running exposure
CLOSETIME	hh:mm:ss.th	0 for success	Sets the close time between exposures cycles
CLOSETIME?	none	hh:mm:ss.th	Queries the close time between exposures cycles
EXPCLOSE?	none	hh:mm:ss.th	Queries present close time for a running exposure
TIMETOGO?	none	hh:mm:ss.th	Queries the time left in the present exposure period (open or close)
EXPCYCLE?	none	i	Returns the number of exposure cycles currently running

REPEAT	i	0 for success	Sets the number of exposure cycles to be run
REPEAT?	none	i	Returns the number of exposure cycles to run
AUTOSETUP	none	0 for success	Begins auto setup sequence
QTH?	none	1: OPS-Q Models 0: OPS-A Models	Queries model types
FLUX?	none	ffff.ff	Queries the flux value
FLUXMULT?	none	ffff.ff	Queries the flux multiplier
FLUXMULT	ffff.ff	0 for success	Sets the flux multiplier
FLUXCONTROL?	none	1: on 0: off	Queries status on flux control
DETECTOR?	none	ffff.ff	Queries the detector, returns uA
COOLER?	none	1 = ready 0 = not ready	Queries the status of the cooler controller
IDLE%?	none	1.0 = idle on 0.0 = idle off	Query the idle status, only return 1.0 or 0.0
IDLE%	1.0 = idle on 0.0 = idle off	0 for success	Set the idle mode, 0.0 turn off idle mode, any non-zero number will turn on idle mode

FAULT?	none	decimal integer value 0 = no errors bit definitions for errors: bit 0 = flux control operating at max range bit 1 = flux control operated at min range bit 2 = auto setup failed to find range bit 3 = auto setup with cooler not ready bit 4 = auto setup failed to see signal bit 5 = auto setup detector saturated bit 6 = auto setup failed to find set point bit 7 = received command not understood bit 8 = received parameter invalid for command	Queries flux control fault
AUDIOOFF	none	0 for success	Disable buzzer even in a fault condition
AUDIOON	none	0 for success	Enable buzzer, buzzer will be turned on when error occurs

WARRANTY AND SERVICE CONTACTING ORIEL INSTRUMENTS

Oriel Instruments belongs to Newport Corporation's family of brands. Thanks to a steadfast commitment to quality, innovation, hard work and customer care, Newport is trusted the world over as the complete source for all photonics and laser technology and equipment.

Founded in 1969, Newport is a pioneering single-source solutions provider of laser and photonics components to the leaders in scientific research, life and health sciences, photovoltaics, microelectronics, industrial manufacturing and homeland security markets.

Newport Corporation proudly serves customers across Canada, Europe, Asia and the United States through 9 international subsidiaries and 24 sales offices worldwide. Every year, the Newport Resource catalog is hailed as the premier sourcebook for those in need of advanced technology products and services. It is available by mail request or through Newport's website. The website is where one will find product updates, interactive demonstrations, specification charts and more.

To obtain information regarding sales, technical support or factory service, United States and Canadian customers should contact Newport Corporation directly.

Newport Corporation
1791 Deere Avenue
Irvine, CA 92606 USA

Telephone: 800-222-6440 (toll-free in United States)
949-253-1727

Fax: 949-253-1680

Sales: oriel.sales@newport.com
Technical assistance: oriel.tech@newport.com
Repair Service: rma.service@newport.com

Customers outside of the United States must contact their regional representative for all sales, technical support and service inquiries. A list of worldwide representatives can be found on Newport's website: <http://www.newport.com>.

REQUEST FOR ASSISTANCE / SERVICE

Please have the following information available when requesting assistance or service:

Contact information for the owner of the product.
Instrument model number (located on the product label).
Product serial number and date of manufacture (located on the product label).
Description of the problem.

To help Oriel's Technical Support Representatives diagnose the problem, please note the following:

Is the system used for manufacturing or research and development?
What was the state of the system right before the problem?
Had this problem occurred before? If so, when and how frequently?
Can the system continue to operate with this problem, or is it non-operational?
Were there any differences in the application or environment before the problem occurred?

REPAIR SERVICE

This section contains information regarding factory service for this product. The user should not attempt any maintenance or service of the system beyond the procedures outlined in this manual. This product contains no user serviceable parts other than what is noted in this manual. Any problem that cannot be resolved should be referred to Oriel Instruments.

If the instrument needs to be returned for service, a Return Material Authorization (RMA) number must be obtained prior to shipment to Oriel Instruments. This RMA number must appear on both the shipping container and the package documents.

Return the product to Oriel Instruments, freight prepaid, clearly marked with the RMA number and it either will be repaired or replaced at Oriel's discretion.

Oriel is not responsible for damage occurring in transit. The Owner of the product bears all risk of loss or damage to the returned Products until delivery at Oriel's facility. Oriel is not responsible for product damage once it has left the facility after repair or replacement has been completed.

Oriel is not obligated to accept products returned without an RMA number. Any return shipment received by Oriel without an RMA number may be reshipped by Newport, freight collect, to the Owner of the product.

NON-WARRANTY REPAIR

For Products returned for repair that are not covered under warranty, Newport's standard repair charges shall be applicable in addition to all shipping expenses. Unless otherwise stated in Newport's repair quote, any such out-of-warranty repairs are warranted for ninety (90) days from date of shipment of the repaired Product.

Oriel will charge an evaluation fee to examine the product and determine the most appropriate course of action. Payment information must be obtained prior to having an RMA number assigned. Customers may use a valid credit card, and those who have an existing account with Newport Corporation may use a purchase order.

When the evaluation had been completed, the owner of the product will be contacted and notified of the final cost to repair or replace the item. If the decision is made to not proceed with the repair, only the evaluation fee will be billed. If authorization to perform the repair or provide a replacement is obtained, the evaluation fee will be applied to the final cost. A revised purchase order must be submitted for the final cost. If paying by credit card, written authorization must be provided that will allow the full repair cost to be charged to the card.

WARRANTY REPAIR

If there are any defects in material or workmanship or a failure to meet specifications, notify Oriel Instruments promptly, prior to the expiration of the warranty.

Except as otherwise expressly stated in Oriel's quote or in the current operating manual or other written guarantee for any of the Products, Oriel warrants that, for the period of time set forth below with respect to each Product or component type (the "Warranty Period"), the Products sold hereunder will be free from defects in material and workmanship, and will conform to the applicable specifications, under normal use and service when correctly installed and maintained. Oriel shall repair or replace, at Oriel's sole option, any defective or nonconforming Product or part thereof which is returned at Buyer's expense to Oriel facility, provided, that Buyer notifies Oriel in writing promptly after discovery of the defect or nonconformity and within the Warranty Period. Products may only be returned by Buyer when accompanied by a return material authorization number ("RMA number") issued by Oriel, with freight prepaid by Buyer. Oriel shall not be responsible for any damage occurring in transit or obligated to accept Products returned for warranty repair without an RMA number. Buyer bears all risk of loss or damage to the Products until delivery at Oriel's facility. Oriel shall pay for shipment back to Buyer for Products repaired under warranty.

WARRANTY PERIOD

All Products (except consumables such as lamps, filters, etc.) described here are warranted for a period of twelve (12) months from the date of shipment or 3000 hours of operation, whichever comes first.

Lamps, gratings, optical filters and other consumables / spare parts (whether sold as separate Products or constituting components of other Products) are warranted for a period of ninety (90) days from the date of shipment.

WARRANTY EXCLUSIONS

The above warranty does not apply to Products which are (a) repaired, modified or altered by any party other than Oriel; (b) used in conjunction with equipment not provided or authorized by Oriel; (c) subjected to unusual physical, thermal, or electrical stress, improper installation, misuse, abuse, accident or negligence in use, storage, transportation or handling, alteration, or tampering, or (d) considered a consumable item or an item requiring repair or replacement due to normal wear and tear.

DISCLAIMER OF WARRANTIES: EXCLUSIVE REMEDY

THE FOREGOING WARRANTY IS EXCLUSIVE AND IN LIEU OF ALL OTHER WARRANTIES. EXCEPT AS EXPRESSLY PROVIDED HEREIN, ORIEL MAKES NO WARRANTIES, EITHER EXPRESS OR IMPLIED, EITHER IN FACT OR BY OPERATION OF LAW, STATUTORY OR OTHERWISE, REGARDING THE PRODUCTS, SOFTWARE OR SERVICES. NEWPORT EXPRESSLY DISCLAIMS ANY IMPLIED WARRANTIES OF MERCHANTABILITY OR FITNESS FOR A PARTICULAR PURPOSE FOR THE PRODUCTS, SOFTWARE OR SERVICES. THE OBLIGATIONS OF ORIEL SET FORTH IN THIS SECTION SHALL BE ORIEL'S SOLE LIABILITY, AND BUYER'S SOLE REMEDY, FOR BREACH OF THE FOREGOING WARRANTY. Representations and warranties made by any person including distributors, dealers and representatives of Oriel / Newport Corporation which are inconsistent or in conflict with the terms of this warranty shall not be binding on Oriel unless reduced to writing and approved by an expressly an authorized officer of Newport.

LOANER / DEMO MATERIAL

Persons receiving goods for demonstrations or temporary use or in any manner in which title is not transferred from Newport shall assume full responsibility for any and all damage while in their care, custody and control. If damage occurs, unrelated to the proper and warranted use and performance of the goods, recipient of the goods accepts full responsibility for restoring the goods to their original condition upon delivery, and for assuming all costs and charges.

Confidentiality & Proprietary Rights

Reservation of Title:

The Newport programs and all materials furnished or produced in connection with them ("Related Materials") contain trade secrets of Newport and are for use only in the manner expressly permitted. Newport claims and reserves all rights and benefits afforded under law in the Programs provided by Newport Corporation.

Newport shall retain full ownership of Intellectual Property Rights in and to all development, process, align or assembly technologies developed and other derivative work that may be developed by Newport. Customer shall not challenge, or cause any third party to challenge the rights of Newport.

Preservation of Secrecy and Confidentiality and Restrictions to Access:

Customer shall protect the Newport Programs and Related Materials as trade secrets of Newport, and shall devote its best efforts to ensure that all its personnel protect the Newport Programs as trade secrets of Newport Corporation. Customer shall not at any time disclose Newport's trade secrets to any other person, firm, organization, or employee that does not need (consistent with Customer's right of use hereunder) to obtain access to the Newport Programs and Related Materials. These restrictions shall not apply to information (1) generally known to the public or obtainable from public sources; (2) readily apparent from the keyboard operations, visual display, or output reports of the Programs; 3) previously in the possession of Customer or subsequently developed or acquired without reliance on the Newport Programs; or (4) approved by Newport for release without restriction.

First printing 2015

© 2015 by Newport Corporation, Irvine, CA. All rights reserved.

No part of this manual may be reproduced or copied without the prior written approval of Newport Corporation.

This manual has been provided for information only and product specifications are subject to change without notice. Any change will be reflected in future printings.

Newport Corporation 1791 Deere Avenue Irvine, CA, 92606 USA