



User's Guide

Current Source / TE Controller Module
LCM-39427/437



ILX Lightwave · 31950 Frontage Road · Bozeman, MT, U.S.A. 59715 · U.S. & Canada: **1-800-459-9459** · International Inquiries: 406-556-2481 · Fax 406-586-9405

ilx.custhelp.com · www.newport.com/ilxlightwave



TABLE OF CONTENTS



Safety Information and the Manual v

General Safety Considerations v

Safety Symbols vi

 Safety Marking Symbols vi

Warrantyvii

 Limitationsvii

 Returning an Instrumentvii

 Claims for Shipping Damageviii

 Comments, Suggestions, and Problems ix

Chapter 1 Introduction and Specifications

Specifications 2

Chapter 2 Installation and Operation

Installing the LCM-39427/437 Module 5

Removing the LCM-39427/437 Module 6

Operation 6

The LASER Connector 8

Connecting to Your Laser 8

 Laser Diode Connections and Shielding 8

Photodiode Feedback Connections 11

Grounding Considerations 12

Thermistor Current Switch 12

The TEC Connector 13
 TEC Grounding Considerations 13
TEC Interlock 13
Booster Operation 14

Chapter 3 Calibration

Recommended Equipment 16
 Environmental Conditions 16
 Warm Up 16
Laser Controller Calibration Procedures 17
 Local Operation Current Source Calibration 17
 Remote Operation Current Source Calibration 18
 Local Operation I_{PD} Current Calibration 19
 Remote Operation IPD Current Calibration 21
 Local Operation Laser Voltage Measurement Calibration 23
 Remote Operation Laser Voltage Measurement Calibration 24
TEC Calibration Procedures 25
 Local Operation Thermistor Calibration 25
 Remote Operation Thermistor Calibration 26
 Local Operation ITE Current Calibration 27
 Remote Operation ITE Current Calibration 28



LIST OF FIGURES



Figure 2.1	LCM-39427/437 Back Panel	7
Figure 2.2	Back Panel LD Connector	8
Figure 2.3	Common Laser Cathode - Photodiode Cathode	9
Figure 2.4	Common Laser Cathode - Photodiode Anode	9
Figure 2.5	Common Laser Anode - Photodiode Cathode	10
Figure 2.6	Common Laser Anode - Photodiode Anode	10
Figure 2.7	Back Panel TEC Connector	13
Figure 3.1	I _{PD} Calibration Circuit	19

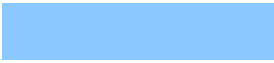

LIST OF FIGURES

SAFETY AND WARRANTY INFORMATION



The Safety and Warranty Information section provides details about cautionary symbols used in the manual, safety markings used on the instrument, and information about the Warranty including Customer Service contact information.

Safety Information and the Manual

Throughout this manual, you will see the words *Caution* and *Warning* indicating potentially dangerous or hazardous situations which, if not avoided, could result in death, serious or minor injury, or damage to the product. Specifically:

CAUTION

Caution indicates a potentially hazardous situation which can result in minor or moderate injury or damage to the product or equipment.

WARNING

Warning indicates a potentially dangerous situation which can result in serious injury or death.

General Safety Considerations

If any of the following conditions exist, or are even suspected, do not use the instrument until safe operation can be verified by trained service personnel:

- Visible damage
- Severe transport stress
- Prolonged storage under adverse conditions
- Failure to perform intended measurements or functions

If necessary, return the instrument to ILX Lightwave, or authorized local ILX Lightwave distributor, for service or repair to ensure that safety features are maintained (see the contact information on page ix). All instruments returned to ILX Lightwave are required to have a Return Authorization Number assigned by an official representative of ILX Lightwave Corporation. See Returning an Instrument on page vii for more information.











SAFETY SYMBOLS

This section describes the safety symbols and classifications. Technical specifications including electrical ratings and weight are included within the manual. See the Table of Contents to locate the specifications and other product information. The following classifications are standard across all ILX Lightwave products:

- Indoor use only
- Ordinary Protection: This product is NOT protected against the harmful ingress of moisture.
- Class I Equipment (grounded type)
- Electrical Rating: 100 - 240 V; ~ 2.5A; 225W; 50/60 Hz
- Mains supply voltage fluctuations are not to exceed $\pm 10\%$ of the nominal supply voltage.
- Pollution Degree 2
- Installation (overvoltage) Category II for transient overvoltages
- Maximum Relative Humidity: <80% RH, non-condensing
- Operating temperature range of 10 °C to 40 °C
- Storage and transportation temperature of -40 °C to 70 °C
- Maximum altitude: 3000 m (9843 ft)
- This equipment is suitable for continuous operation.

Safety Marking Symbols

This section provides a description of the safety marking symbols that appear on the instrument. These symbols provide information about potentially dangerous situations which can result in death, injury, or damage to the instrument and other components.

 <p>Caution, refer to manual</p>	 <p>Earth ground Terminal</p>	 <p>Alternating current</p>	 <p>Visible and/or invisible laser radiation</p>
 <p>Caution, risk of electric shock</p>	 <p>Protective Conductor Terminal</p>	 <p>Caution, hot surface</p>	 <p>Frame or chassis Terminal</p>
 <p>On: In position of a bistable push control. The slash (/) only denotes that mains are on.</p> <p>or (/)</p>		 <p>Off: Out position of a bistable push control. The circle (O) only denotes that mains are off.</p> <p>or (O)</p>	

WARRANTY

ILX LIGHTWAVE CORPORATION warrants this instrument to be free from defects in material and workmanship for a period of one year from date of shipment. During the warranty period, ILX will repair or replace the unit, at our option, without charge.

Limitations

This warranty does not apply to fuses, lamps, defects caused by abuse, modifications, or to use of the product for which it was not intended.

This warranty is in lieu of all other warranties, expressed or implied, including any implied warranty of merchantability or fitness for any particular purpose. ILX Lightwave Corporation shall not be liable for any incidental, special, or consequential damages.

If a problem occurs, please contact ILX Lightwave Corporation with the instrument's serial number, and thoroughly describe the nature of the problem.

Returning an Instrument

If an instrument is to be shipped to ILX Lightwave for repair or service, be sure to:

- 1 Obtain a Return Authorization number (RA) from ILX Customer Service.
- 2 Attach a tag to the instrument identifying the owner and indicating the required service or repair. Include the instrument serial number from the rear panel of the instrument.
- 3 Attach the anti-static protective caps that were shipped with the instrument and place the instrument in a protective anti-static bag.
- 4 Place the instrument in the original packing container with at least 3 inches (7.5 cm) of compressible packaging material. **Shipping damage is not covered by this warranty.**
- 5 Secure the packing box with fiber reinforced strapping tape or metal bands.
- 6 Send the instrument, transportation pre-paid, to ILX Lightwave. Clearly write the return authorization number on the outside of the box and on the shipping paperwork. ILX Lightwave recommends you insure the shipment.

If the original shipping container is not available, place your instrument in a container with at least 3 inches (7.5 cm) of compressible packaging material on all sides.

Repairs are made and the instrument returned transportation pre-paid. Repairs are warranted for the remainder of the original warranty or for 90 days, whichever is greater.

Claims for Shipping Damage

When you receive the instrument, inspect it immediately for any damage or shortages on the packing list. If the instrument is damaged, file a claim with the carrier. The factory will supply you with a quotation for estimated costs of repair. You must negotiate and settle with the carrier for the amount of damage.



Comments, Suggestions, and Problems

To ensure that you get the most out of your ILX Lightwave product, we ask that you direct any product operation or service related questions or comments to ILX Lightwave Customer Support. You may contact us in whatever way is most convenient:

Phone (800) 459-9459 or (406) 586-1244

Fax (406) 586-9405

On the web at: www.newport.com/ilxlightwave

Or mail to:

ILX Lightwave
31950 Frontage Road
Bozeman, Montana, U.S.A 59715
www.newport.com/ilxlightwave.com

When you contact us, please have the following information:

Model Number: _____

Serial Number: _____

End-user Name: _____

Company: _____

Phone: _____

Fax: _____

Description of what is connected to the ILX Lightwave instrument:

Description of the problem:

If ILX Lightwave determines that a return to the factory is necessary, you are issued a Return Authorization (RA) number. Please mark this number on the outside of the shipping box.

You or your shipping service are responsible for any shipping damage when returning the instrument to ILX Lightwave; ILX recommends you insure the shipment. If the original shipping container is not available, place your instrument in a container with at least 3 inches (7.5 cm) of compressible packaging material on all sides

SAFETY AND WARRANTY INFORMATION

Warranty

INTRODUCTION AND SPECIFICATIONS

CAUTION

The LCM-39427/437 module requires LDC-3900 firmware version 2.7 or greater. Usage with previous versions of firmware may produce unpredictable results.

The LCM-39427/437 Current Source/TE Controller Module is a precision laser controller (current source and temperature controller) module for use in the LDC-3900 Modular Laser Diode Controller. It may be installed in any of the four bays at the rear of the LDC-3900 (and may readily be interchanged with any other LDC-3900 module).

Features of the LCM-39427/437 include:

- Service-free modularity (calibration information is stored on the LCM-39427/437)
- Closed-case calibration
- High-stability, low noise design
- Flexible setup with LDC-3900 Save/Recall front panel functions
- Photodiode feedback control mode

Specifications

	LCM-39427	LCM-39437
Isolation	Each module is isolated from other modules and earth ground. TEC and current source independently isolated.	
Output Connectors		
Current Source Output	9-pin, D-sub	9-pin, D-sub
Photodiode Input	15-pin, D-sub	15-pin, D-sub
Drive Current Output¹		
Output Current Range ⁹	0 - 500 mA	0 - 1000 mA
Setpoint Resolution	10 μ A	100 μ A
Setpoint Accuracy	$\pm 0.05\%$ of FS	$\pm 0.1\%$ of FS
Compliance Voltage	6V	6V
Temperature Coefficient	100 ppm / $^{\circ}$ C	100 ppm / $^{\circ}$ C
Short-Term Stability (one hour) ²	25 ppm	25 ppm
Long-Term Stability (24 hours) ³	50 ppm	50 ppm
Noise and Ripple (μ A / rms) ⁴		
Unfiltered	<4 μ A	<4 μ A
With Model 320 Filter ⁵	<1.5 μ A	<1.5 μ A
Transients		
Operational ⁶	<1 mA	<1 mA
1kV EFT	<4 mA	<4 mA
Surge ⁷	<7 mA	<7 mA
Drive Current Limit Settings		
Range	0 - 500 mA	0 - 1000 mA
Accuracy	± 5 mA	± 510 mA
Photodiode Feedback		
Type	Current input differential, zero bias, all modules	
Range	20 - 4000 μ A	20 - 4000 μ A
Output Stability ⁸	N/A	N/A
Setpoint Accuracy	N/A	N/A
External Analog Modulation		
Input	0-10V, 10 k Ω	0-10V, 10 k Ω
Transfer Function	50 mA / V	100 mA / V
Bandwidth (3dB)	DC to 250 kHz	DC to 200 kHz

Drive Current Measurement (Display)		
Output Current Range	0 - 500.00 mA	0 - 1000.0 mA
Output Current Resolution	0.01 mA	0.01 mA
Output Current Accuracy ¹⁰	±0.5 mA	±1 mA
Photodiode Current Range	0 - 4000 µA	0 - 4000 µA
PD Current Resolution	1 µA	1 µA
PD Responsivity Range	0.00 - 1000.00 µA / mW	0.00 - 1000.00 µA / mW
PD Responsivity Resolution	0.01 µA / mW	0.01 µA / mW
Optical Power Range	0.00 - 1000.0 mW	0.00 - 1000.0 mW
Optical Power Resolution	10 µW	10 µW
Voltage Range	0-7V	0-7V
Voltage Accuracy	±5 mV	±5 mV
Temperature Control Output⁹		
Temperature Control Range ¹¹	-99.9°C to 99.9 °C	-99.9°C to 99.9 °C
Thermistor Setpoint		
Resolution (-20°C to +20°C)	0.1°C	0.1°C
Accuracy (-20°C to +20°C)	±0.2°C	±0.2°C
Resolution (+20°C to +50°C)	0.2°C	0.2°C
Accuracy (+20°C to +50°C)	±0.2°C	±0.2°C
Short Term Stability (1 hour) ¹³	<±0.05°C	<±0.05°C
Long Term Stability (24 hours) ¹⁴	<±0.1°C	<±0.1°C
Output Type	Bipolar, constant current source, all modules	
Compliance Voltage	>6V DC	>6V DC
Short Circuit Output Current	2A	2A
Maximum Output Power	12W	12W
Current Noise and Ribble	<1 mA rms	<1 mA rms
Current Limit Range	0 - 2 A	0 - 2 A
Current Limit Set Accuracy	0.05 A	0.05 A
Control Algorithm	Smart Integrator, Hybrid PI, all modules	
Temperature Sensor		
Types	Thermistor (2-wire NTC)	Thermistor (2-wire NTC)
Thermistor Sensing Current	10/100 µA (user-selectable)	10/100 µA (user-selectable)
Usable Thermistor Range	20 - 450,000Ω typical	20 - 450,000Ω typical
User Calibration	Steinhart-Hart	Steinhart-Hart

TEC Measurement (Display)		
Temperature Range	-99.9°C to 99.9°C	-99.9°C to 99.9°C
Thermistor Resistance		
10 μ A Setting	0.00 - 450.00 k Ω	0.00 - 450.00 k Ω
100 μ A Setting	0.000 - 45.000 k Ω	0.000 - 45.000 k Ω
TE Current	-2.000 to 2.000 A	-2.000 to 2.000 A
Temperature Accuracy	± 0.5 °C	± 0.5 °C
Thermistor Resistance Accuracy		
10 μ A Setting	± 0.05 k Ω	± 0.05 k Ω
100 μ A Setting	± 0.005 k Ω	± 0.005 k Ω
TE Current	± 0.05 A	± 0.05 A

- 1 All values measured after a one-hour warm-up period.
- 2 Over any one hour period, half-scale output.
- 3 Over any 24 hour period, half-scale output.
- 4 Measured from resulting intensity fluctuations of a laser diode, measured optically with a 150 kHz bandwidth photo detector. Measurements made with 1 MHz detector are typically 10% higher.
- 5 ILX Lightwave model LNF-320 low-noise filter option may be used if lower noise performance is required.
- 6 Maximum output current transient resulting from normal operational situations (e.g., power on-off), as well as accidental situations (e.g., power line plug removal). For more information request ILX "Transient Test Standards" #LDC-00196.
- 7 Maximum output current transient resulting from a 1000V power line transient spike. Tested to ILX Lightwave Technical Standard #LDC-00196.
- 8 Maximum monitor photodiode current drift over any 30-minute period. Constant-power mode stability specification assumes zero drift in detector responsivity.
- 9 Output current rated into a 1 Ω load.
- 10 Measured at 25°C.
- 11 Software limits of range.
- 12 Accuracy figures quoted for a 10k Ω thermistor. Accuracy figures are relative to calibration standard. Both resolution and accuracy are dependent on the user-defined configuration of the instrument.
- 13 Over any one-hour period at 25°C. Short-term temperature stability is a strong function of the thermal environment of the thermistor and TE module. Room air currents in particular can easily cause fluctuations of 0.1°C in an exposed mounting configuration.
- 14 Over any 24 hour period at 25°C.

In keeping with our commitment to continuing improvement, ILX Lightwave reserves the right to change specifications without notice and without liability for such changes.

INSTALLATION AND OPERATION

This section describes the procedures for installing and removing a LCM-39427/437 module from the LDC-3900.

Note: The LDC-3900 will power-up in a default state upon detecting any change in the LDC 3900 system configuration (such as installing a new module). All parameters and SAVE/RECALL settings will be set to default values, based on the new configuration. Calibration data is stored in the LCM-39427/437 module itself, and is never lost due to reconfiguration of the LDC-3900.

Installing the LCM-39427/437 Module

To install the LCM-39427/437 module into the LDC-3900, follow these steps:

- 1 Turn the LDC-3900 power off.
- 2 Place the LCM-39427/437 module into an open bay on the back of the LDC-3900 and slide the module into place. There are tracks at the top and bottom of the bay which guide the module into place. Push the module into place until the board edge clicks into place with an audible "pop." This indicates that the module is "locked" into place. Fasten module to the mainframe with the Module Locking Screws (see Figure 2.1) to secure the module. It is then ready to be used in the LDC-3900.
- 3 Power-up the LDC-3900.
- 4 After the LDC-3900 has completed its power-up sequence, the (ADJUST) LAS and TEC indicators which correspond to the newly installed LCM-39427/437 module should be lit in green, indicating that the module has been recognized as a LASER controller in its respective bay.

CAUTION

Removing and installing modules with the mainframe powered up (hot swapping) will damage the module and/or the mainframe.

Removing the LCM-39427/437 Module

To remove the LCM-39427/437 module from the LDC-3900, follow these steps:

- 1 Turn the LDC-3900 power off.
- 2 Unfasten the Module Locking Screws (see Figure 4.1) on the LCM-39427/437 module back panel.
- 3 Grasp the LCM-39427/437 module by the handle which extends from the bottom of the back panel. Gently, but firmly, pull the module out of the LDC-3900.
- 4 If the LCM-39427/437 module is replaced in the LDC-3900 before the LDC-3900 is powered up again, the LDC-3900 will retain its memory of all parameter settings and SAVE/RECALL values. However, if the LDC-3900 is powered up and detects a change in its system configuration, all parameters and SAVE/RECALL information will be lost. Calibration data is stored in the LCM-39427/437 module itself, and is never lost due to reconfiguration of the LDC-3900.

Operation

This section describes the procedures for connecting and running a laser diode with the LCM-39427/437 module. Refer to Chapter 2 of the LDC-3900 Instruction Manual for front panel description and operation.

Refer to Figure 2.1 for the following discussion of connections to the LCM-39427/437.

Note: The LCM-39427/437 module only operates from the front panel with both the TEC and LASER outputs turned on or off together.

If you wish to run the LCM-39427/437 current source with no temperature control, the TEC output must be shorted (or a dummy load connected) to pins 1/2 and 3/4 of the TEC connector. Also, a sensor load resistor (i. e. 10K Ohms) must be connected between pins 7 and 8).

If you wish to run the LCM-39427/437 TEC controller with no laser (current) output, the LAS interlock pins 1 and 2 must be shorted. Also, the LAS output pins 4/5 and 8/9 must be shorted.

With LDC-3900 v3.1 and higher, the LAS and TEC outputs may be controlled independently using the LAS:ONLY:OUT and TEC:ONLY:OUT commands.

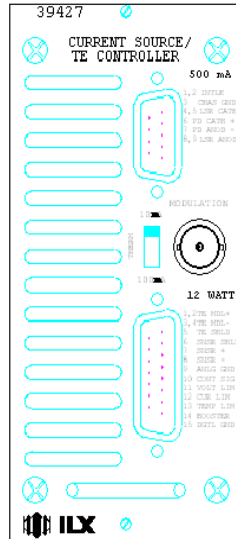

Figure 2.1 LCM-39427/437 Back Panel

When operating the LCM-39427/437 module, note the following differences from a standard module in the LDC-3900 front panel operation:

- Pressing the ADJUST switch will toggle between LAS adjust, TEC adjust and none.
- The (OUTPUT) ON switch turns both the LAS and TEC outputs on or off together. They are always both on or off.
- The (LASER MODE) SELECT switch selects I mode only. (I_{LBW} and Constant Power mode are not available on the LCM-39427/437 modules).

The LASER Connector

On the back panel of the LCM-39427/437 you will find a 9-pin D-connector for the LD connections. The pinout diagram for this connector is shown in Figure 2.2.

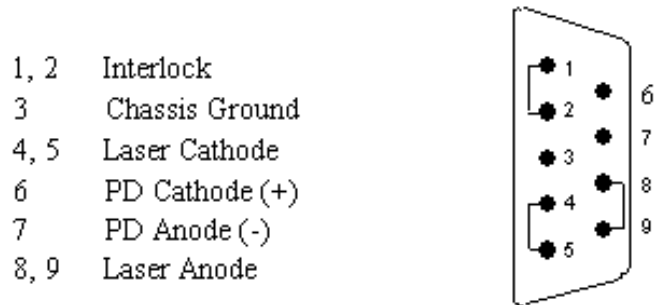

Figure 2.2 Back Panel LD Connector

Connecting to Your Laser

When connecting laser diodes and other sensitive devices to the LCM-39427/437, we recommend that the LDC-3900 be powered up and the LASER output be off (OUTPUT LED off). In this condition, a low impedance shunt is active across the output terminals. When disconnecting devices, it is only necessary to turn the OUTPUT off.

Laser Diode Connections and Shielding

IMPORTANT - Before connecting the laser diode to the LDC-3900 Modular Laser Diode Controller, be sure that the front panel OUTPUT LED is off (output off). Before turning on the LASER output, be sure that the current limit has been correctly set.

The following figures show the possible configurations of connecting laser diodes and photodiodes with the LDC-3900 Modular Laser Diode Controller and LCM-39427 or 39437 modules.

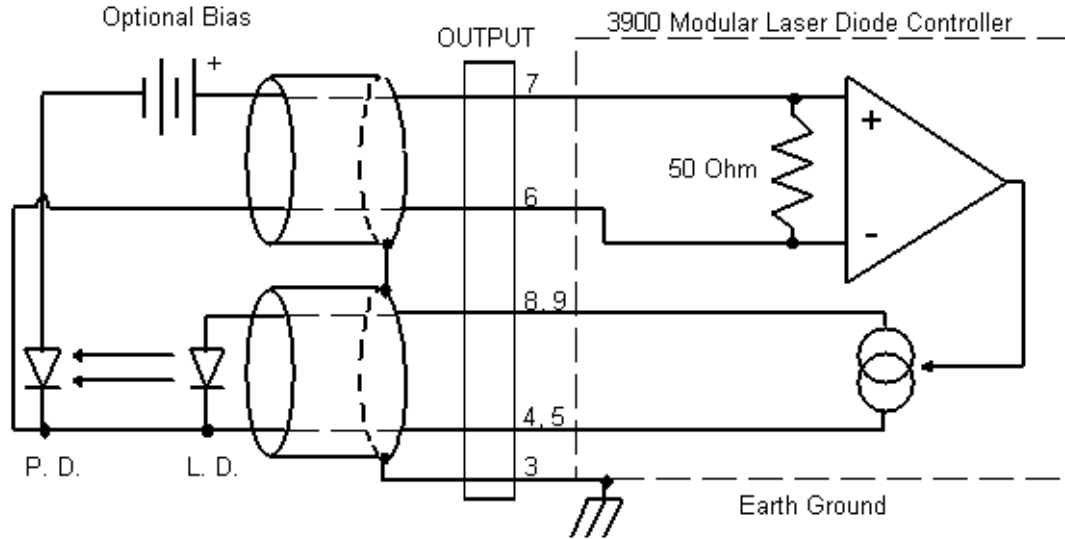

Figure 2.3 Common Laser Cathode - Photodiode Cathode

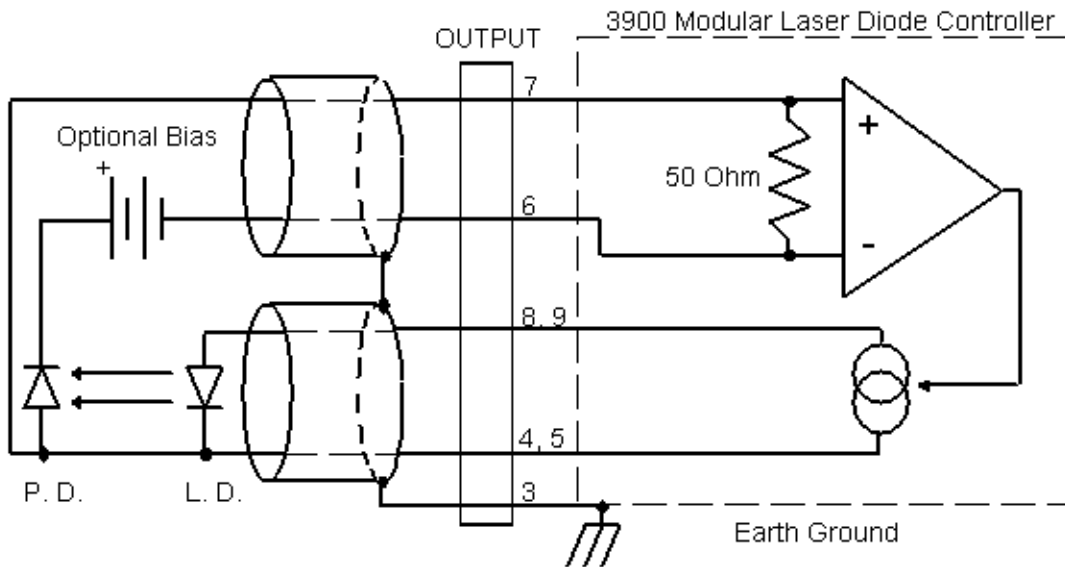

Figure 2.4 Common Laser Cathode - Photodiode Anode

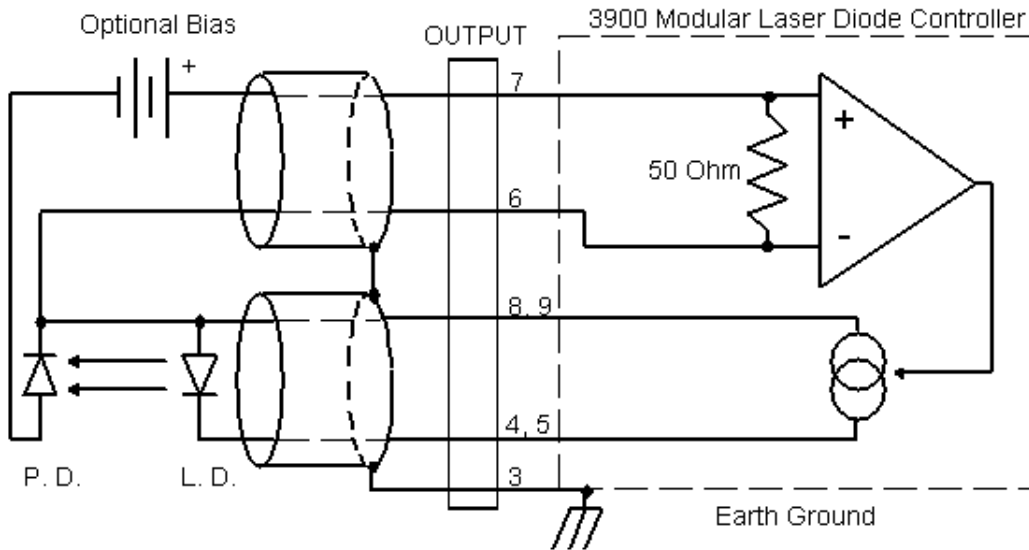

Figure 2.5 Common Laser Anode - Photodiode Cathode

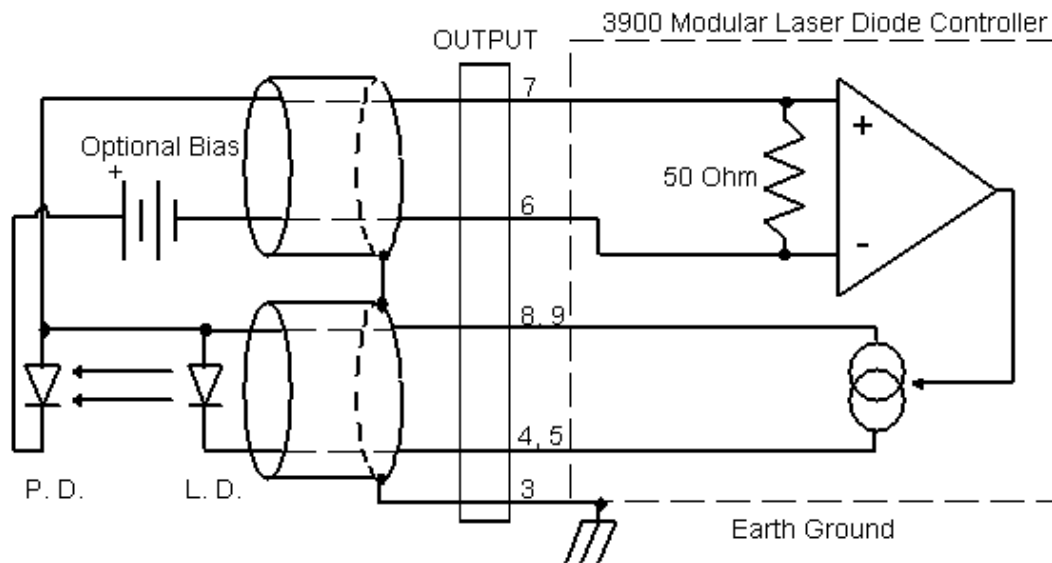

Figure 2.6 Common Laser Anode - Photodiode Anode

CAUTION

The cable connections to the laser must be secure enough that they won't open-circuit, should they be jostled or bumped. Should an open circuit occur during laser operation, the LASER output will be turned off automatically.

Experience indicates that should an open circuit occur during laser operation (while the LASER is ON), the laser may be damaged by a momentary circuit break-and-remake before the final circuit break. Although the LCM-39427/437 provides a proprietary debounce protection circuit for the LASER output, secure cabling is important.

It is recommended that the connections to the LCM-39427/437 output be made using twisted wire pairs with an earth-grounded shield (see Figures 2.3 - 2.6). The output terminals of the current source are left floating relative to earth ground to suppress AC power-on/power-off transients that may occur through an earth-ground path. If the output circuit is earth-grounded at some point (such as through the laser package and mount), the user must be careful to avoid multiple earth grounds in the circuit. Multiple earth grounds may provide circuit paths that induce spurious currents in the photodiode feedback circuit and output leads.

Photodiode Feedback Connections

The connector on the back panel of the LCM-39427/437 contains the current supply output. The photodiode signal is input at the connector at pins 6 and 7. The LCM-39427/437 photodiode input is zero biased.

Many laser diode modules contain an internal photodiode that monitors the back-facet emission of the laser. Usually, this photodiode is internally connected to either the laser anode or cathode. The previous figures show the recommended connections and shielding for the various configurations of laser diode modules and photodiode feedback schemes.

The photodiode and laser inputs on the LCM-39427/437 are electrically isolated from ground and each other. So, if a 4 pin connection is made (no common connections) no additional jumpers are required. The previous figures show the recommended connections and shielding for 3-pin lasers (where the common connection is internal to the device). A 4-pin laser should be connected with the same shielding as shown in Figures 2.3 to 2.6, but the common shield connection (between the photodiode and the laser) is optional.

Grounding Considerations

The current source outputs of the LCM-39427/437 are isolated from chassis ground allowing either output terminal to be grounded at the user's option. Figures 2.3 - 2.6 show the proper earth-ground shielding for laser diode/photodiode connections.

Thermistor Current Switch

The THERM switch is used to select the thermistor source current level. Table 2.1 shows the THERM positions and corresponding position code. When the THERM switch is changed during TEC mode operation, the new current source range code will be indicated on the TEC display for three seconds.

Table 2.1 SENSOR SELECT Switch Positions

Switch Position	Code
100 μ A	--01
10 μ A	--02

The 10 μ A and 100 μ A designations are for the thermistor current level. When using a thermistor, the thermistor supply current depends on the thermistor operating temperature range and the required temperature resolution.

The TEC Connector

On the LCM-39427/437 back panel, you will find the 15-pin D-connector for the TEC MODULE. This connector is used for the input and output connections, as shown by the pin-out diagram of Figure 2.7.

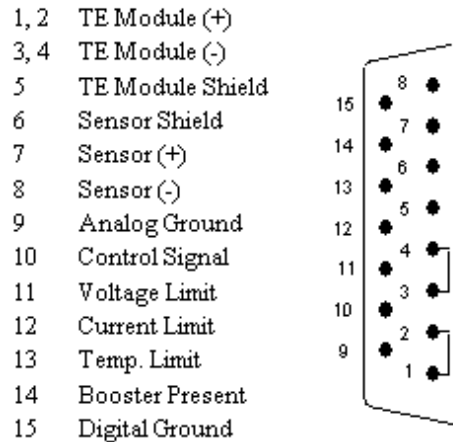

Figure 2.7 Back Panel TEC Connector

TEC Grounding Considerations

DO NOT allow Sensor (-) to connect to TEC Module (-) or TEC Module (+) directly or through a common ground. Even a momentary connection when the output is off will cause damage to the instrument and/or device. For the TEC connector, if any one terminal pin is grounded, then no other terminal pin should be grounded. Instrument damage caused by shorting these pins is not covered under warranty.

TEC Interlock

On the back panel TEC connector, pins 13 (TEMP LIMIT) and 15 (DIGITAL GND) form a type of interlock. These two pins are normally not connected (open circuit), and must remain open for the TEC output to be on. If there is a short circuit between these pins the TEC output will be disabled. When this short circuit is present, the TEC Interlock Error condition/event will be reported in the TEC Event Status Register and the TEC Condition Status Register.

This circuit is useful for remote monitoring of temperature, and therefore is labeled TEMP LIMIT on the back panel connector. This interlock is intended for use with an external current booster. A switch or control circuit of the user's own design is required.

Booster Operation

The LCM-39427/437 may be used to control a booster current source which accepts a control signal of up to ± 10.0 volts. A booster current source may be required if the LCM-39427/437's output is not adequate to control a thermal load.

Whenever a connection is present between the BOOSTER PRESENT (pin 14) and DIGITAL GROUND (pin 15) of the back panel TEC Input/Output connector, the (BOOSTER) CONTROL SIGNAL (pin 10) voltage will be available for controlling a booster TEC current source.

The Booster Enabled condition is reported in the TEC Condition Status register. Through the GPIB interface, this condition may be used to trigger a service request.

The booster current source should use the control voltage which is available between the (BOOSTER) CONTROL SIGNAL (pin 10) and ANALOG GND (pin 9) of the back panel TEC connector.

When the BOOSTER PRESENT signal is connected to DIGITAL GROUND, the LIM I value may be increased above the normal operation maximum of 2.0 Amps, to a maximum of 10.0 Amps. This is permitted for operation with a booster current source so that the CONTROL SIGNAL voltage may be ± 10.0 volts. The CONTROL SIGNAL voltage is linearly proportional to the control current, which is limited by the LIM I parameter.

Whether or not a booster current source is used, the LCM-39427/437 uses a sensor for controlling the temperature. The feedback loop GAIN may require adjustment when a booster current source is used. This is because a booster current source may be used with different thermal loads than those found with normal LCM-39427/437 operation, and those loads may require larger or smaller GAIN values in order to settle to the set temperatures in a desirable fashion. See Section 2.10.6 of the LDC-3900 Instruction Manual for setting the GAIN value.

During operation, if the status of the connection between the BOOSTER PRESENT and DIGITAL GROUND changes, this event will be reported in the TEC Event Status Register. When the GPIB option is implemented, this event may be used to trigger a service request.

CALIBRATION



The LCM-39427/437 should be calibrated every 12 months or whenever performance verification indicates that calibration is necessary.

All calibrations can be done with the case closed. The instrument is calibrated by changing the internally stored digital calibration constants.

Recommended Equipment

Recommended test equipment for calibrating the LCM-39427/437 is listed below. Equipment other than that shown in the table may be used if the specifications meet or exceed those listed. If your LDC-3900 is equipped with the model 1231 GPIB/IEEE 488.2 interface you may refer to later sections in this chapter for calibration procedures using the GPIB, if desired.

Description	Manufacturer/Model	Specification
DMM	HP 3457A	0.1 μ A or 0.1 mV resolution DC Amps (at 1.0 A): \pm 1% Resistance (at 10 Ω): 0.02%
Resistor		49 Ω , 5 W, low TCR, for voltage calibration
I_{PD} Calibration		
Resistors	R1 R2 R3 R4	49 Ω , 1%, 1/4 W 100 Ω , 1%, 1/4 W 5 Ω , 1%, 10 W 1 M Ω , 1%, 1/4 W
Optical Isolator	TIL117	
Connector	D-sub	9-pin male
Battery		9 volts
TEC Calibration		
Resistors	Metal Film High Power	10 K Ω for 100 μ A calibration 100 K Ω for 10 μ A calibration 1 Ω , 10 W, low TCR, for current calibration

Environmental Conditions

Calibrate this instrument under laboratory conditions. We recommend calibration at 23 °C \pm 1.0 °C. When necessary, however, the LCM-39427/437 may be calibrated at its intended use temperature if this is within the specified operating temperature range of 0 to 50 °C.

Warm Up

The LDC-3900 should be allowed to warm up for at least 1 hour before calibration.

Note: For all calibration procedures (except thermistor calibration) a proper load must be present on both the LASER and TEC output connectors. This is because both outputs are always turned on and off together. Calibration procedures may be aborted with no ill effect by powering off the LDC-3900 before the last value is entered for any calibration procedure.

Laser Controller Calibration Procedures

There are three calibration procedures that need to be made for the LCM-39427/437. They are calibration of the constant current source, calibration of the laser voltage measurement, and calibration of the photodiode current measurement circuits.

The LCM-39427/437 implements a two-point calibration for the Laser current source. Two current levels are applied to a load, and the resulting measured currents are fed back (by the user) to the LCM-39427/437. The LCM-39427/437 calibration program uses the two data points to calculate calibration constants that it will thereafter use to set current.

If you use the IEEE-488.2/GPIB interface, follow the procedures in the remote operation current source calibration section to calibrate the LCM-39427/437 remotely.

Local Operation Current Source Calibration

The following procedure is for local (front panel) operation. At the end of this procedure, the instrument will automatically calibrate the current limit.

- 1 Select the LCM-39427/437 to be calibrated by pressing the appropriate (ADJUST) LAS/TEC switch until the LAS indicator is orange. Set the LASER current limit (LIM I) to 450 mA (90% of full scale), and current set point to 400 mA (80% of full scale). Connect a calibrated DMM to measure the current through pins 5 to 8.
- 2 Turn the (LASER ENABLE) ON switch and press the appropriate (OUTPUT) ON switch to turn the LASER output on. If the LASER output is not on, the LASER I calibration mode cannot be entered. If the LASER output is on, but the LASER channel is not selected (see Step 1), calibration will be performed improperly.
- 3 Enter the LASER I calibration mode by pushing the (GPIB) LOCAL and (LASER DISPLAY) I switches at the same time. The LASER display will indicate output current in mA. The LDC-3900 will beep when it is ready to accept a new calibration value.
- 4 Press and hold in the (PARAMETER) SET switch and turn the ADJUST knob until the LASER display indicates the same current as measured via the DMM.
- 5 Release the (PARAMETER) SET switch to accept the first calibration value. After the (LASER DISPLAY) SET switch is released, the LDC-3900 will beep. It will then apply the second calibration current, approximately one-fourth of the original current.
- 6 The LDC-3900 will beep when it is ready to accept the second calibration value. When it does, press and hold in the (PARAMETER) SET switch and turn the ADJUST knob until the LASER display indicates the same current as measured via the DMM.
- 7 Release the (PARAMETER) SET switch to accept the second calibration value. After the (PARAMETER) SET switch is released, the LDC-3900 will perform a limit calibration, then calculate the calibration constants, store them to nonvolatile memory on the LCM-39427/437, beep, and return to its former (before calibration) state after about 15 seconds.

Remote Operation Current Source Calibration

The following procedure is for remote (GPIB) operation.

- 1 Select the LCM-39427/437 to be calibrated by sending the "LAS:CHAN x" command, where x is the channel of the LCM-39427/437. Set the LASER limit to 90% of full scale via the "LAS:LIM:I 450" command, and current set point to 80% of full scale via the "LAS:LDI 400" command. Connect a calibrated DMM to measure the current through pins 5 to 8.
- 2 Turn the (LASER ENABLE) ON switch. Enter the "LAS:OUT ON" command to turn the LASER output on. If the LASER output is not on, the LASER I calibration mode cannot be entered. (The TEC output will also be on.)
- 3 Enter the LASER I calibration mode by issuing the "LAS:CAL:LDI" command. The LDC-3900 will beep when it is ready to accept the first calibration point.
- 4 Input the first actual (measured) LASER output current (as an <nrf value>) via the "LAS:LDI <nrf value>" command.

If this value is to be measured and entered remotely via a GPIB controlled DMM, for example, the measured value of the current should not be entered until the LDC-3900 is ready to receive it.

The LDC-3900 will be ready to receive the current value when, after a "LAS:CAL:LDI?" query is sent, the response from the LDC-3900 is "1". This query should be issued every 1 - 3 seconds. The instrument should be ready for calibration in about 1 - 2 seconds.

- 5 Once the actual I value is entered via the "LAS:LDI" command, the LDC-3900 will beep and will apply a new current equal to approximately one-fourth (1/4) the previous set current. The LDC-3900 will be ready to receive the second current value when, after a "LAS:CAL:LDI?" query is sent, the response from the LDC-3900 is "1".
- 6 Input the second actual (measured) LASER output current (as an <nrf value>) as in Step 4.
- 7 Once the second actual I value is entered via the "LAS:LDI" command, the LDC-3900 will beep, a limit calibration will be performed, and then the new calibration constants will be calculated and stored into non-volatile memory on the LCM-39427/437. The "OPC?" query may be used (after the "LAS:LDI" value is sent) to determine when the calibration is completed. This will take about 15 seconds to complete.

The operation complete flag (bit 0 of the Standard Event Status Register) may be used to trigger a service request. This type of interrupt is enabled by setting bit 0 of the Service Request Enable register (via the *ESE command) and bit 5 of the Service Request Enable register (via the *SRE command). Service request (SRQ) handling depends on your GPIB hardware. Refer to your GPIB user's manual for details.

Local Operation I_{PD} Current Calibration

The following procedure is for calibrating the photodiode current measurement. There is no constant power mode supported in this module. When these values are reached and are stable, the user enters the actual value of the current, as measured by an external DMM. The LCM-39427/437 then automatically calibrates the LASER feedback circuits.

This procedure is for local (front panel) operation.

- 1 Select the LCM-39427/437 to be calibrated by pressing the appropriate (ADJUST) switch until the LAS indicator is orange. With the LASER output off, connect a calibrated ammeter to the PD Anode output of the LCM-39427/437, and connect the circuit of Figure 3.1 to the LASER and PD outputs.

If a calibrated ammeter (with 0.1 μA resolution) is not available, place a calibrated DMM (with 0.1 mV resolution) to measure the voltage across the resistor, R1, as shown in Figure 3.1. Calculate the current in the following steps by using Ohm's Law:

$$I = E / R$$

-where E is the accurately measured voltage across the resistor, and R is the accurately measured load resistance. (A 4-point probe resistance measurement is recommended.)

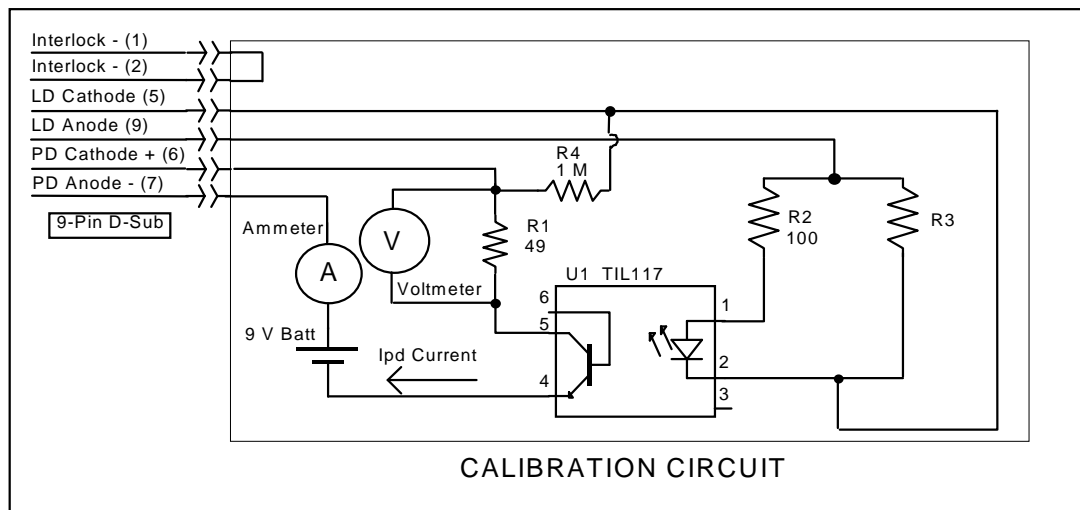

Figure 3.1 I_{PD} Calibration Circuit

- 2 Set the LASER current limit (LIM I) to 500 mA. Set the current set point to about 150 mA.
- 3 Turn the (LASER ENABLE) ON switch and press the appropriate (OUTPUT) ON switch to turn the LASER output on. (The TEC output will also be on.) If the LASER output is not on, the LASER I_{PD} calibration mode cannot be entered. Adjust the current set point until the measured I_{PD} value is about 4000 μA. The measured I_{PD} value can be viewed by pressing the (LASER DISPLAY) I_{PD}/P_{PD} switch.

- 4 Press the (GPIB) LOCAL and (LASER DISPLAY) I_{PD}/P_{PD} switches at the same time to place the LCM-39427/437 in its LASER I_{PD} Calibration mode. After a few seconds the LDC-3900 will beep and the LASER display will show the I_{PD} set point value.
- 5 After the value on the LASER display is stable (has not changed by more than one digit for several seconds) the LCM-39427/437 is ready for the actual I_{PD} value to be entered.

Press and hold in the (PARAMETER) SET switch and turn the ADJUST knob until the LASER display shows the correct value, as shown on the calibrated ammeter (or the calculated I_{PD} value from Step 1).

- 6 Release the (PARAMETER) SET switch to store the first calibration value into non-volatile memory. It will then expect the second calibration current, approximately one-fourth of the original current.
- 7 The LDC-3900 will beep when it is ready to accept the second calibration value. When it does, press and hold in the (PARAMETER) SET switch and turn the ADJUST knob until the LASER display indicates the same current (as measured directly, or as calculated in Step 1, from the measured voltage).
- 8 Release the (PARAMETER) SET switch to accept the second calibration point. After the (PARAMETER) SET switch is released, the LDC-3900 will calculate the calibration constants, store them to nonvolatile memory on the LCM-39427/437, beep, and return to its former (before calibration) state.

Remote Operation IPD Current Calibration

The following procedure is for calibrating the photodiode measurement over GPIB. When these values are reached and are stable, the user enters the actual value of the current, as measured by an external DMM. The LCM-39427/437 then automatically calibrates the LASER feedback circuits.

This procedure is for remote (GPIB) operation.

- 1 With the LASER output off, connect a calibrated ammeter to the PD Anode output of the LCM-39427/437, and connect the circuit of Figure 3.1 to the LASER and PD outputs.

If a calibrated ammeter (with 0.1 μA resolution) is not available, place a calibrated DMM (with 0.1 mV resolution) to measure the voltage across the resistor, R1, as shown in Figure 3.1. Calculate the current in the following steps by using Ohm's Law:

$$I = E / R$$

-where E is the accurately measured voltage across the resistor, and R is the accurately measured load resistance. (A 4-point probe resistance measurement is recommended.)

- 2 Select the LCM-39427/437 to be calibrated by sending the "LAS:CHAN x" command, where x is the channel of the LCM-39427/437. Set the LASER current limit via the "LAS:LIM:I 200" command. Set the IPD set point to 150 mA via the "LAS:MDI 150" command.
- 3 Turn the (LASER ENABLE) ON switch. Enter the "LAS:OUT ON" command to turn the LASER output on. (The TEC output will also be on.) If the LASER output is not on, the LASER I_{PD} calibration mode cannot be entered.
- 4 Enter the "LAS:MDI?" query to read back the I_{PD} measurement. Adjust the current via the "LAS:LDI x" command until the I_{PD} measurement is about 3600 μA . The greater the current, the greater the I_{PD} value will become. Continue this process until the "LAS:MDI?" returns a value between 3500 and 3600 μA . Then, enter the "LAS:CAL:MDI" command to place the LCM-39427/437 in its Laser I_{PD} Calibration mode.
- 5 After a few seconds, the LDC-3900 will be ready. Enter the first actual I_{PD} current value (as an <nrf value>) via the "LAS:MDI <nrf value>" command.

The measured value of the current should not be entered until the LDC-3900 is ready to receive it. The LDC-3900 will beep when it is ready to accept a new calibration value.

The LDC-3900 will be ready to receive the I_{PD} value when, after a "LAS:CAL:MDI?" query is sent, the response from the LDC-3900 is "1".

- 6 Once the actual I_{PD} value is entered via the "LAS:MDI" command, the LDC-3900 will beep and the new calibration value will be stored into non-volatile memory. It will then set the current to approximately one-fifth of the original I_{PD} value and wait for the second calibration value to be entered. The LDC-3900 will be ready to receive the second I_{PD} value when, after a "LAS:CAL:MDI?" query is sent, the response from the LDC-3900 is "1".
- 7 Input the second actual (measured) I_{PD} current (as an <nrf value>) as in Step 5.

- 8 Once the second actual monitor diode current value is entered via the "LAS:MDI" command, the LDC 3900 will beep and the new calibration constants will be calculated and stored into non-volatile memory in the LCM-3900. The "OPC?" query may be used (after the "LAS:MDI" value is sent) to determine when the calibration is completed.

The operation complete flag (bit 0 of the Standard Event Status Register) may be used to trigger a service request. This type of interrupt is enabled by setting bit 0 of the Service Request Enable register (via the *ESE command) and bit 5 of the Service Request Enable register (via the *SRE command). Service request (SRQ) handling depends on your GPIB hardware. Refer to your GPIB user's manual for details.

Local Operation Laser Voltage Measurement Calibration

The following procedure is for calibrating the LASER voltage measurement via the front panel.

- 1 With the LASER output off, connect a calibrated voltmeter, in parallel with a $49\ \Omega$, 5 Watt, low temperature coefficient resistor, to the LASER output of the LCM-39427/437 (pins 5 and 8).
- 2 Select the LCM-39427/437 to be calibrated by pressing the appropriate (ADJUST) switch until the LAS indicator is orange. Set the LASER current limit (LIM I) to 200 mA. Set the LASER I set point to 100 mA.
- 3 Turn the (LASER ENABLE) ON switch and press the appropriate (OUTPUT) ON switch to turn the LASER output on. (The TEC output will also be on.) If the LASER output is not on, the LASER voltage calibration mode cannot be entered.
- 4 Press the (GPIB) LOCAL and (LASER DISPLAY) V switches at the same time to place the LCM-39427/437 in its LASER Voltage Calibration mode.
- 5 After a few seconds, the LDC-3900 will beep when it is ready to accept a new calibration value. Press and hold in the (PARAMETER) SET switch and turn the ADJUST knob to enter the LASER voltage measurement value which appears on the DMM. Release the (PARAMETER) SET switch to enter the value.

Once the actual voltage value is entered, the LDC-3900 will beep. It will then set the output to approximately one-fourth of the original voltage, and then it will expect the second calibration voltage point to be entered

- 6 Input the second actual (measured) LASER voltage (as an <nrf value>) as in Step 5.
- 7 Once the second actual voltage value is entered, the LDC-3900 will beep and the new calibration constants will be calculated and stored into non-volatile memory on the LCM-39427/437.

Remote Operation Laser Voltage Measurement Calibration

The following procedure is for calibrating the LASER voltage measurement via GPIB.

- 1 With the LASER output off, connect a calibrated voltmeter, in parallel with a 49 Ω , 5 Watt, low temperature coefficient resistor, to the LASER output of the LCM-39427/437 (pins 5 and 8).
- 2 Select the LCM-39427/437 to be calibrated by sending the appropriate "LAS:CHAN x" command, where x is the channel number of the LCM-39427/437. Set the LASER current limit via the "LAS:LIM:I 200". Set the I set point via the "LAS:LDI 100" command.
- 3 Turn the (LASER ENABLE) ON switch. Enter the "LAS:OUT ON" command to turn the LASER output on. (The TEC output will also be on.) If the LASER output is not on, the LASER voltage calibration mode cannot be entered.
- 4 Enter the "LAS:CAL:LDV" command to place the LCM-39427/437 in its LASER Voltage Calibration mode.
- 5 After a few seconds, the LDC-3900 will be ready for the actual laser voltage to be entered (as an <nrf value>) via the "LAS:LDV <nrf value>" command. The measured value of the voltage should not be entered until the LDC-3900 is ready to receive it.

The LDC-3900 will be ready to receive the voltage value when, after a "LAS:CAL:LDV?" query is sent, the response from the LDC-3900 is "1".

- 6 Once the actual voltage value is entered via the "LAS:LDV" command, the LDC-3900 will beep. It will then expect the second calibration voltage point, approximately one-fourth of the original voltage. The LDC-3900 will be ready to receive the second voltage value when, after a "LAS:CAL:LDV?" query is sent, the response from the LDC-3900 is "1".
- 7 Input the second actual (measured) LASER voltage (as an <nrf value>) as in Step 5.
- 8 Once the second actual voltage value is entered via the "LAS:LDV" command, the LDC-3900 will beep and the new calibration constants will be calculated and stored into non-volatile memory on the LCM-39427/437.

The operation complete flag (bit 0 of the Standard Event Status Register) may be used to trigger a service request. This type of interrupt is enabled by setting bit 0 of the Service Request Enable register (via the *ESE command) and bit 5 of the Service Request Enable register (via the *SRE command). Service request (SRQ) handling depends on your GPIB hardware. Refer to your GPIB user's manual for details.

Note: For all calibration procedures (except thermistor calibration) a proper load must be present on both the LASER and TEC output connectors. This is because both outputs are always turned on and off together. Calibration procedures may be aborted with no ill effect by powering off the LDC-3900 before the last value is entered for any calibration procedure.

TEC Calibration Procedures

There are two calibration procedures required for the TEC section of the LCM-39427/437. They are calibration of the resistance at the 10 microamp and the 100 microamp thermistor source current settings, and calibration of the ITE current and limits.

Local Operation Thermistor Calibration

The following procedure is for calibrating the 100 μA and 10 μA thermistor constant current sources so that the thermistor resistances for these ranges will be as accurate as possible. Use nominal values of 10 $\text{K}\Omega$ for the 100 μA setting and 100 $\text{K}\Omega$ for the 10 μA setting. This procedure is for local (front panel) operation.

- 1 Set the THERM RANGE switch on the back panel of the LCM-39427/437 to the 100 μA position. Select the LCM-39427/437 for calibration by pressing the appropriate (ADJUST) LAS/TEC switch (so that the TEC indicator is orange).
- 2 Measure and record the exact resistance of your metal film resistors. (A 4-point probe resistance measurement is recommended.) These resistors are very temperature sensitive (calibration can be impacted by the warmth of your fingers while holding the resistor). Attempt to measure the resistors and calibrate the instrument at the same temperature.
- 3 Connect the correct metal film resistor to the thermistor input of the LCM-39427/437 TE connector (pins 7 and 8, see Figure 2.1).
- 4 Enter the TEC sensor calibration mode by pushing the (GPIB) LOCAL and (TEC DISPLAY) R switches at the same time. The TEC display will become blank for 2 seconds, then the sensor code (SENSOR SELECT switch position) value will be displayed for 2 seconds. After this, the TEC display will indicate sensor resistance in $\text{K}\Omega$. The LDC-3900 will beep when it is ready to accept a new calibration value.
- 5 Press and hold in the (PARAMETER) SET switch and turn the ADJUST knob until the TEC display indicates the same resistance you recorded for the metal film resistor.
- 6 Release the (PARAMETER) SET switch to store the new value into non-volatile memory on the LCM-39427/437. After the (PARAMETER) SET switch is released, the LDC-3900 will beep and return to its former state (before calibration).
- 7 Switch the THERM RANGE switch (back panel of the LCM-39427/437) to the 10 μA position and repeat this procedure with the other resistor.

Remote Operation Thermistor Calibration

The following procedure is for calibrating the 100 μA and 10 μA thermistor constant current sources so that the thermistor resistances for these ranges will be as accurate as possible. Use nominal values of 10 $\text{K}\Omega$ for the 100 μA setting and 100 $\text{K}\Omega$ for the 10 μA setting. This procedure is for remote (GPIB) operation.

- 1 Set the THERM RANGE switch on the back panel of the LCM-39427/437 to the 100 μA position.
- 2 Measure and record the exact resistance of your metal film resistors. (A 4-point probe resistance measurement is recommended.) These resistors are very temperature sensitive (calibration can be impacted by the warmth of your fingers while holding the resistor). Attempt to measure the resistors and calibrate the instrument at the same temperature.
- 3 Connect the correct metal film resistor to the LCM-39427/437 thermistor input (pins 7 and 8, see Figure 4.1). Use nominal values of 10 $\text{K}\Omega$ for the 100 μA setting and 100 $\text{K}\Omega$ for the 10 μA setting.
- 4 Enter the "TEC:CHAN x" command over the GPIB to select the channel of the LCM-39427/437 to be calibrated, where x = the channel number.

Enter the "TEC:CAL:SENsor" command. The TEC display will show the resistance value. The LDC 3900 will beep when it is ready to accept a new calibration value.

If this value is to be measured and entered remotely via a GPIB controlled DMM, for example, the measured value of the resistance should not be entered until the LDC-3900 is ready to receive it.

The LDC-3900 will be ready to receive the resistance value when, after a "TEC:CAL:SEN?" query is sent, the response from the LDC-3900 is "1".

- 5 Input the actual resistance (in k^*) measured by the external DMM (as an <nrf value>) via the "TEC:R <nrf value>" command.

After the "TEC:R" value is entered, the "**OPC?" query may be used to determine when the calibration sequence is done. However, the "**OPC", or "**WAI" command, or "**OPC?" query should not be issued until after the expected "TEC:R" value is entered, or the system will "hang". This happens because the LDC-3900 will wait indefinitely for an input, yet not allow any input until the calibration is finished.

- 6 Once the "TEC:R" value is sent, the LDC-3900 will beep and return to its former state (before calibration). The "OPC?" query may be used (after the "TEC:R" value is sent) to determine when the calibration is completed.

The operation complete flag (bit 0 of the Standard Event Status Register) may be used to trigger a service request. This type of interrupt is enabled by setting bit 0 of the Service Request Enable register (via the *ESE command) and bit 5 of the Service Request Enable register (via the *SRE command). Service request (SRQ) handling depends on your GPIB hardware. Refer to your GPIB user's manual for details.

- 7 Switch the THERM RANGE switch (back panel) to the 10 μA position and repeat this procedure with the other resistor.

Local Operation ITE Current Calibration

The following procedure is for calibrating the ITE constant current source for both polarities of current. This procedure calibrates the zero current set point automatically, then it automatically drives the TE current output to internally set limits of ± 1 amp. When each of these values is reached and is stable, the user enters the actual value of the current, as measured by an external DMM. The LDC-3900 then automatically calibrates the TEC current source and limits.

This procedure is for local (front panel) operation.

- 1 With the output off, connect a 1Ω , 10 W resistor across the TEC output terminals (on the TE OUTPUT connector, see Figure 4.1) and use a calibrated DMM to measure the voltage across the resistor.

Calculate the current in the following steps by using Ohm's Law:

$$I = E / R$$

-where E is the accurately measured voltage across the resistor, and R is the accurately measured load resistance. (A 4-point probe resistance measurement is recommended.)

Select the LCM-39427/437 for calibration by pressing the appropriate (ADJUST) LAS/TEC switch (so that the TEC indicator is orange). If the TEC output is not off, the TEC current calibration mode cannot be entered.

- 2 Press the (GPIB) LOCAL and (TEC DISPLAY) ITE switches at the same time to place the LCM-39427/437 in its TEC Current Calibration mode. The OUTPUT must be off to enter the TEC calibration mode. The LDC-3900 will automatically turn the LCM-39427/437 OUTPUT on during calibration, when it is required.

The TEC display will show a value of about zero amps as the LCM-39427/437 calibrates itself for a zero current level. After about 20 seconds the LDC-3900 will beep and the TEC display will begin to change to show about 1 amp, for calibration.

- 3 After the value on the TEC display is stable (has not changed by more than one digit for several seconds) the LDC-3900 is ready for the actual I value to be entered.

Press and hold in the (PARAMETER) SET switch and turn the ADJUST knob until the TEC display shows the correct value, as calculated from Step 1.

- 4 Release the (PARAMETER) SET switch to store the new calibration value into non-volatile memory on the LCM-39427/437. The LDC-3900 will then beep to indicate that it is ready for the user to enter the calibration value for its negative polarity output.
- 5 Repeat Steps 3 and 4 for the negative polarity of the TEC output current. After the value for the negative polarity of the TEC output is entered, the LCM-39427/437 will automatically calibrate its current limits and set points. After a few seconds, the LDC-3900 will return to its former state (before calibration). The LDC-3900 will beep when it has finished storing all of the new calibration values.

Remote Operation ITE Current Calibration

The following procedure is for calibrating the ITE constant current source for both polarities of current. This procedure calibrates the zero current set point automatically, then it automatically drives the TE current output to internally set limits of ± 1 amp. When each of these values is reached and is stable, the user enters the actual value of the current, as measured by an external DMM. The LDC-3900 then automatically calibrates the TEC current source and limits.

This procedure is for remote (GPIB) operation.

- 1 With the output off, connect a 1 Ω , 10 W resistor across the TEC output terminals and use a calibrated DMM to measure the voltage across the resistor. Calculate the current in the following steps by using Ohm's Law:

$$I = E / R$$

-where E is the accurately measured voltage across the resistor, and R is the accurately measured load resistance. (A 4-point probe resistance measurement is recommended.)

- 2 Enter the "TEC:CHAN x" command over the GPIB to select the channel of the LCM-39427/437 to be calibrated, where x = the channel number. Enter the "TEC:OUTPUT OFF" command to force the output off.

Enter the "TEC:CAL:ITE" command over the GPIB to place the LCM-39427/437 in its TEC Current Calibration mode. The LDC-3900 will automatically calibrate its zero output current and beep when it is ready to continue. If the TEC output is not off, the TEC current calibration mode cannot be entered.

The LCM-39427/437 will first perform a zero point calibration. This takes about 20 seconds. Then it will set the output to 1 Amp, for calibration.

- 3 When the LDC-3900 is ready for the actual TEC current value to be entered, a remote query of "TEC:CAL:ITE?" will return a response of "1".

When the measured value (actual ITE) is stable and the LDC-3900 is ready to proceed, enter the value by issuing the "TEC:ITE <nrf value>" command, where the absolute value of the actual ITE measurement is the <nrf value>.

To ensure measurement stability of the actual I value when the measurement is taken as a part of an automated test, the DMM measurement should be polled in a loop. When the measured value is consistent within one digit for 5 seconds (for example), the actual I value could be considered stable.

- 4 Once the actual ITE value is entered via the "TEC:ITE" command, the new calibration value is stored into non-volatile memory on the LCM-39427/437. The LDC-3900 will then be ready for the user to enter the negative calibration value.
- 5 Repeat Steps 3 and 4 for the negative polarity of the TEC output current (entering the absolute value of the measurement). After the value for the negative polarity of the TEC output is entered, the LCM-39427/437 will automatically calibrate its current limits and set points. After a few seconds, the LDC-3900 will return to its former state (before calibration). The LDC-3900 will beep when it has finished storing all of the new calibration values.

After the last "TEC:ITE" value is entered, the "*OPC?" query may be used to determine when the calibration sequence is done. However, the "*OPC", or "*WAI" command, or "*OPC?" query should not be issued until after the last "TEC:ITE" value is entered, or the system will "hang". This happens because the LDC-3900 will wait indefinitely for an input, yet not allow any input until the calibration is finished.

If the "*OPC?" query is issued during ITE calibration, the time out period of the GPIB driver should be at least 1 minute to prevent the GPIB driver from timing out and "hanging" the system. Refer to your GPIB driver instruction manual for information on setting the GPIB driver time out period.

The operation complete flag (bit 0 of the Standard Event Status Register) may be used to trigger a service request. This type of interrupt is enabled by setting bit 0 of the Service Request Enable register (via the *ESE command) and bit 5 of the Service Request Enable register (via the *SRE command). Service request (SRQ) handling depends on your GPIB hardware. Refer to your GPIB user's manual for details.

