

NA=0.3

EFL=6.2 mm

CT=3.48 mm

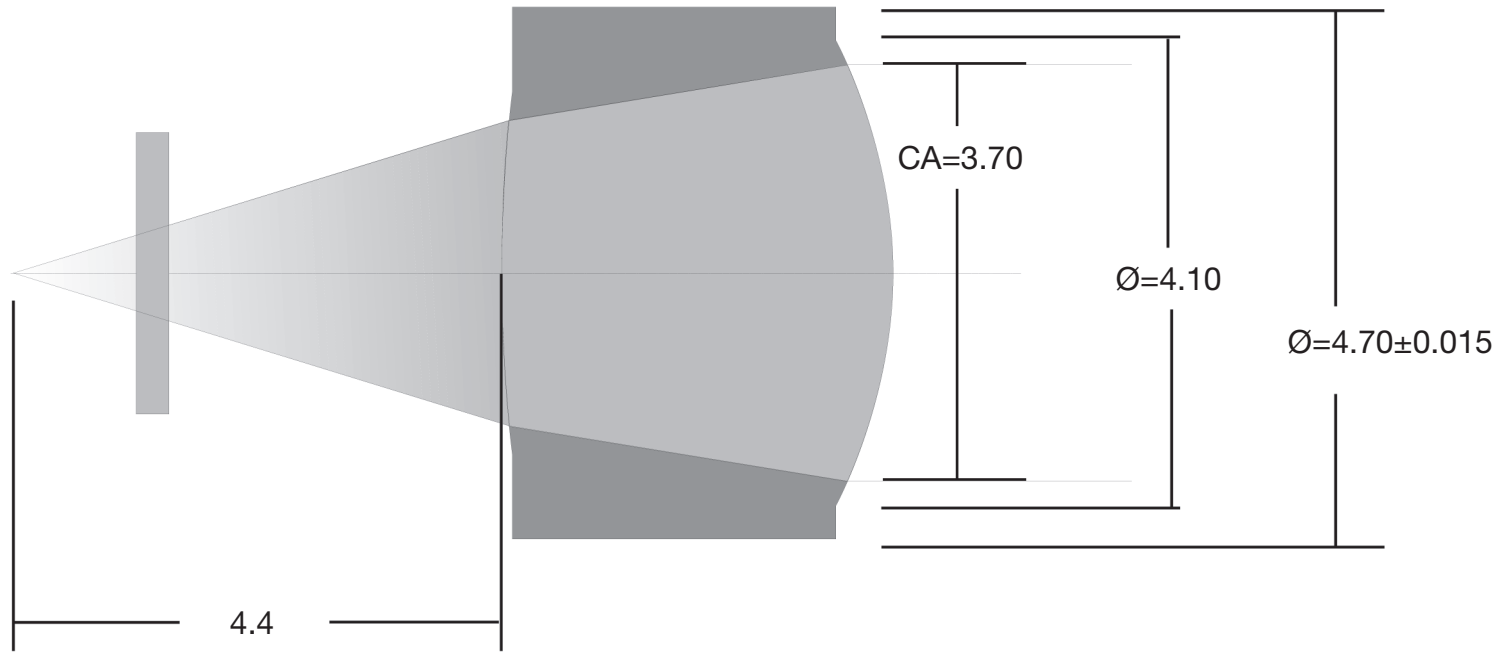

Dimensions in mm