

NA=0.6

EFL=2.7 mm

CT=1.43 mm

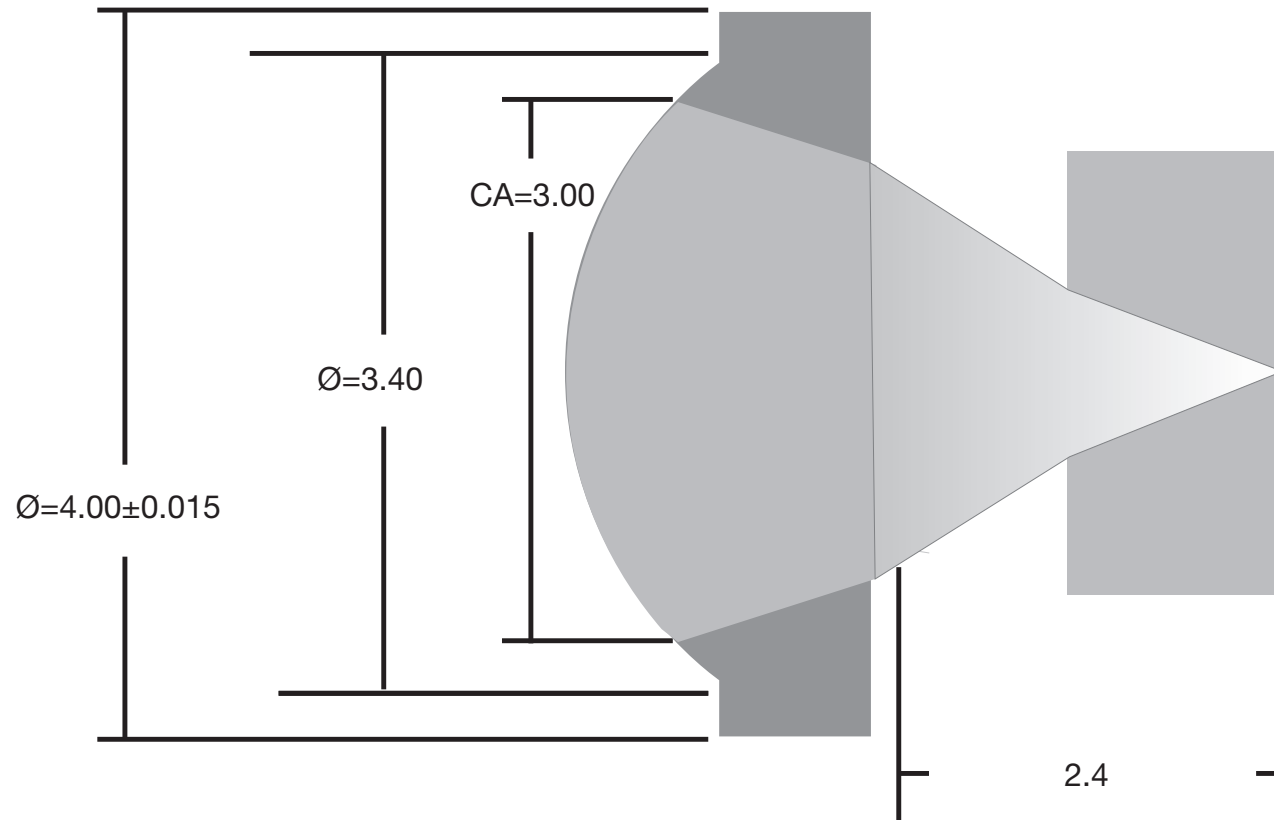

Dimensions in mm