

NA = 0.5

EFL = 3.9 mm

CT = 3.05 mm

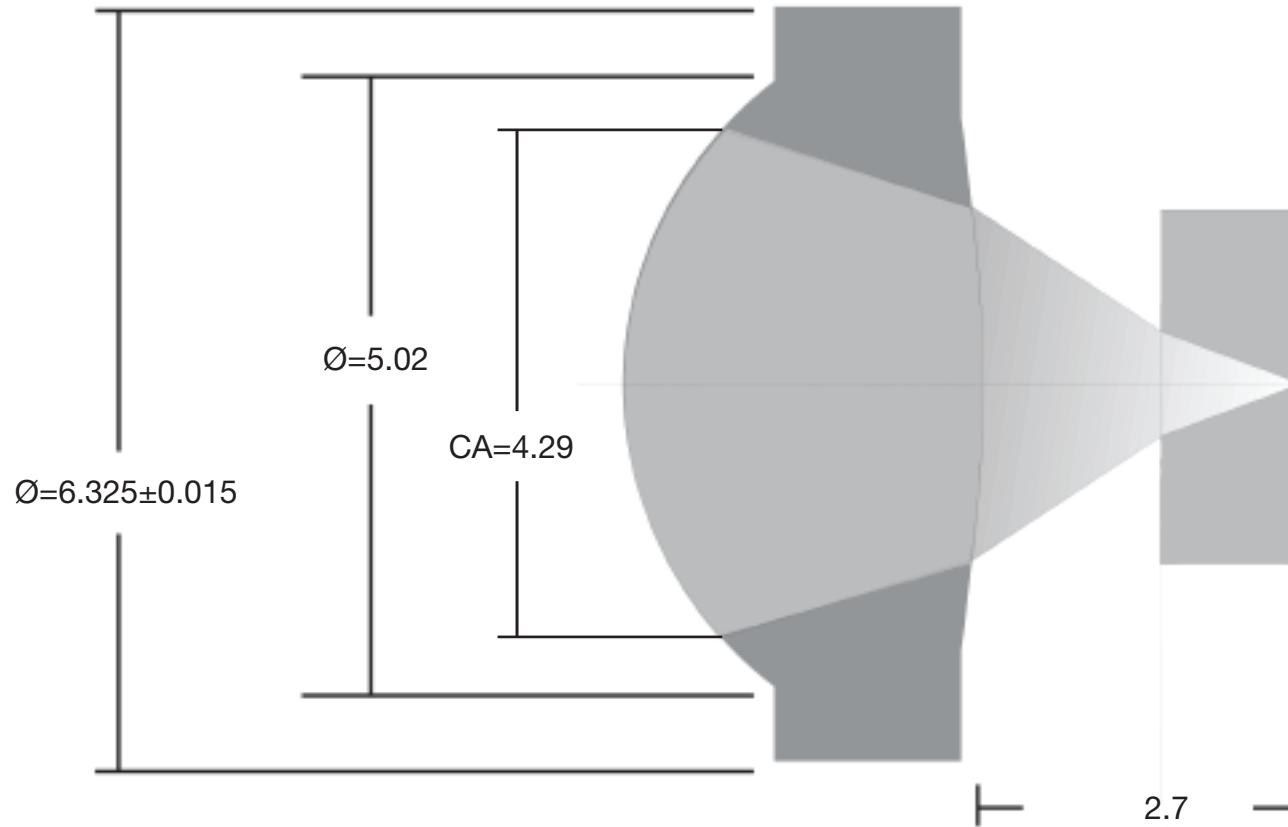

Dimensions in mm