

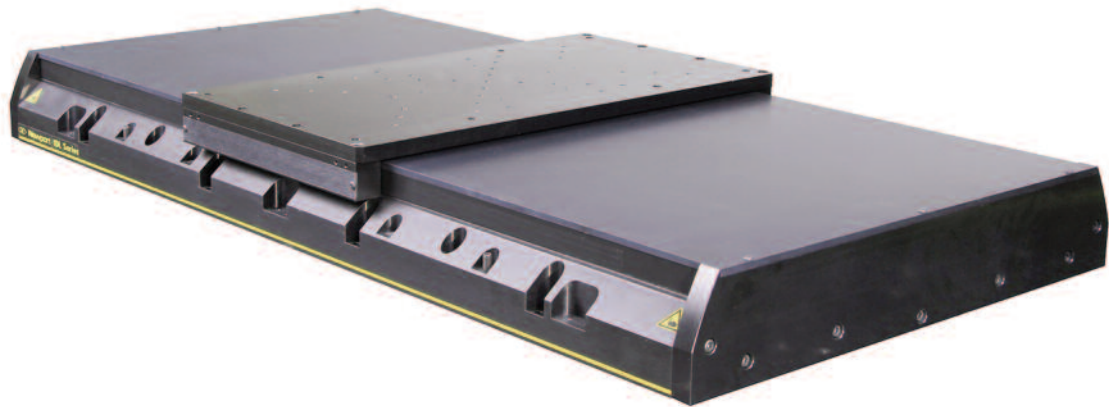

IDL560-LM Series

Long Travel Industrial Linear Stages



 **Newport®**

USER'S MANUAL

Warranty

Newport Corporation warrants this product to be free from defects in material and workmanship for a period of 1 year from the date of shipment. If found to be defective during the warranty period, the product will either be repaired or replaced at Newport's discretion.

To exercise this warranty, write or call your local Newport representative, or contact Newport headquarters in Irvine, California. You will be given prompt assistance and return instructions. Send the instrument, transportation prepaid, to the indicated service facility. Repairs will be made and the instrument returned, transportation prepaid. Repaired products are warranted for the balance of the original warranty period, or at least 90 days.

Limitation of Warranty

This warranty does not apply to defects resulting from modification or misuse of any product or part.

CAUTION



CAUTION

Please return equipment in the original (or equivalent) packing.

You will be responsible for damage incurred from inadequate packaging if the original packaging is not used.

Warranty does not apply to damages resulting from:

- **Incorrect usage:**
 - **Load on the stage greater than maximum specified load.**
 - **Carriage speed higher than specified speed.**
 - **Improper grounding.**
 - **Connectors must be properly secured.**
 - **When the load on the stage represents an electrical risk, it must be connected to ground.**
 - **Excessive or improper cantilever loads.**
- **Modification of the stage or any part thereof.**

This warranty is in lieu of all other warranties, expressed or implied, including any implied warranty of merchantability or fitness for a particular use. Newport Corporation shall not be liable for any indirect, special, or consequential damages.

© 2018 by Newport Corporation, Irvine, CA. All rights reserved.

Original instructions.

No part of this document may be reproduced or copied without the prior written approval of Newport Corporation. This document is provided for information only, and product specifications are subject to change without notice. Any change will be reflected in future publishings.

Table of Contents

Warranty	ii
Declaration of Incorporation	v
Definitions and Symbols.....	vi
Warnings	vii
Caution	ix
<hr/>	
1.0 — Introduction.....	1
<hr/>	
2.0 — Description	2
2.1 Design Details	2
<hr/>	
3.0 — Characteristics.....	3
3.1 Definitions	3
3.2 Mechanical Specifications	4
3.3 Hard Stop: Speed Limitation Versus Load	4
3.4 Load Characteristics and Stiffness	5
3.5 Stage Weights	5
<hr/>	
4.0 — Drive and Motor.....	6
4.1 Motor characteristics (Direct Drive Brushless Motor).....	6
4.2 Command Signals.....	6
4.3 Sensor Positions.....	7
4.4 Position Feedback Signals.....	7
4.5 General Wiring.....	8
4.6 Pinouts.....	8
Hall Effect Sensor (SUB-D15F Connector)	8
Encoder (SUB-D15M Connector).....	8
Encoder (SUB-D26HDM Connector on E5820A Adapter)	9
Motor (DB9W4M Connector).....	9
4.7 IDL560-LM Cable Wirings	9
4.8 Air Tube.....	10
<hr/>	
5.0 — Stage Installation.....	11
5.1 Unpacking	11
5.2 Setting Up.....	11
5.3 Mounting Conditions	13
5.4 Air Blowing.....	13
<hr/>	

6.0	— Connection to Newport Controllers	14
6.1	Warnings on Controllers	14
6.2	Connection	15
6.3	Cables	15
6.4	Adapter for the XPS-D Newport Controller	15

7.0	— Connection to Non-Newport Controllers	16
------------	--	----

8.0	— Dimensions	17
------------	---------------------	----

9.0	— Maintenance	17
9.1	Maintenance	18
9.2	Repair	18
9.3	Calibration	18

Service Form		19
--------------	--	----

Declaration of Incorporation

	DECLARATION OF INCORPORATION OF PARTLY COMPLETED MACHINERY	N° of Certificate IDL560-LM
	following Annex II-1B of the Directive 2006/42/EC on machinery	Number of pages 1/1

THE MANUFACTURER, MICRO-CONTROLE Spectra-Physics, established in France, 9 rue du Bois Sauvage F-91055 Evry
Hereby declares that the partly completed machinery: <ul style="list-style-type: none"> • Description : "IDL560-LM" • Function: Long Travel Industrial Linear Stages. • Model: IDL560-450; LM IDL560-600LM.
– the technical file of which was compiled by: Mr Hervé LE COINTE, Quality Director, MICRO-CONTROLE Spectra-Physics, Zone Industrielle - B.P.29 F-45340 Beauce La Rolande France
– complies with the applicable essential requirements included in Annex I of the Directive 2006/42/EC except § 1.3.7 and 1.1.5 for which a residual risk exists when putting the equipment into service – complies with all the relevant provisions of the Directive 2014/35/EU “Low Voltage” – was designed and built in accordance with the relevant provisions of the Directive 2014/30/EU relating to electro-magnetic compatibility, applying good engineering practices and respecting the information on the intended use of its components – complies with all the relevant provisions of the Directive 2011/65/EU relating to RoHS2.
– was designed and built in accordance with the following harmonised standards: <ul style="list-style-type: none"> • EN ISO 60204-1 « Safety of machinery – Electrical equipment of machines – Part 1 General requirements » • NF EN 61326-1:2013 « Electrical equipment for measurement, control and laboratory use – EMC requirements – Part 1: General requirements » • NF EN ISO 12100:2010 « Safety of machinery – General principles for design – Risk assessment and risk reduction »
Hereby declares that the relevant technical documentation described in Annex VII, part B has been compiled.
Undertakes to present upon request the relevant technical documentation to the competent authorities of the Member States for at least 10 years following this date; the documentation will be available on our manufacturing site in Beauce-La-Rolande (45, France).
Hereby declares that this equipment must not be put into service until the final machinery into which it is to be incorporated has been declared in conformity with the provisions of this Directive.

ORIGINAL DECLARATION

Done in Beauce La Rolande on 22 May 2017
 Hervé LE COINTE
 Quality Director



Definitions and Symbols

The following terms and symbols are used in this documentation and also appear on the product where safety-related issues occur.

General Warning or Caution



The exclamation symbol may appear in warning and caution tables in this document. This symbol designates an area where personal injury or damage to the equipment is possible.

The following are definitions of the Warnings, Cautions and Notes that may be used in this manual to call attention to important information regarding personal safety, safety and preservation of the equipment, or important tips.



WARNING

Warning indicates a potentially dangerous situation which can result in bodily harm or death.



CAUTION

Caution indicates a potentially hazardous situation which can result in damage to product or equipment.

NOTE

Note indicates additional information that must be considered by the user or operator.

Warnings and Cautions



ATTENTION

This stage is a Class A device. In a residential environment, this device can cause electromagnetic interference. In this case, suitable measures must be taken by the user.

WARNING

When the IDL560-LM stage is installed or combined with other instruments in a machine, additional testing to directive 2006/42/EC may be required. It is the responsibility of the end-user or integrator to perform a risk-analysis and the necessary tests to conform to the EC directives.

Newport is not liable for damages caused by not executing this responsibility.

Warnings

Improper use of an IDL560-LM can cause material damage, shock, injury, or death. Read and understand this User's Manual before operating an IDL560-LM stage.

If the IDL560-LM is used in a condition not specified by Newport, the safety features provided by the stage can be impaired.

WARNING

The motion of objects of all types carries potential risks for operators. Ensure the protection of operators by prohibiting access to the dangerous area and by informing the personnel of the potential risks involved.

WARNING

Very fast moving parts of the stage or any attachments can cause crushing or shearing injuries. All personnel must remain clear of any moving parts.

WARNING

The connection of electrical devices must meet safety and electrical standards. Grounding methods indicated in this manual must be applied.

WARNING

Due to the nature of this stage, the installation, use and maintenance of this stage must be performed by trained personnel who are familiar with safety regulations that are applicable to this product.

**WARNING**

The magnetic channel included in this device has the potential to disrupt pacemakers. Consequently, it is recommended that individuals maintain a distance of 1 meter or more from the stage as a precautionary measure.

WARNING

Do not use this stage when its motor is emitting smoke or is unusually hot to the touch or is emitting any unusual odor or noise or is in any other abnormal state.

Stop using the stage immediately, switch off the motor power and then disconnect the electronics power supply.

After checking that smoke is no longer being emitted contact your Newport service facility and request repairs. Never attempt to repair the stage yourself as this can be dangerous.

WARNING

Make sure that this stage is not exposed to moisture and that liquid does not get into the stage.

Nevertheless, if any liquid has entered the stage, switch off the motor power and then disconnect the electronics from power supply.

Contact your Newport service facility and request repairs.

WARNING

Do not insert or drop objects into this stage, this may cause an electric shock, or lock the drive.

Do not use this stage if any foreign objects have entered the stage. Switch off the motor power and then disconnect the electronics power supply.

Contact your Newport service facility for repairs.

WARNING

Do not place this stage in unstable locations such as on a wobbly table or sloping surface, where it may fall or tip over and cause injury.

If this stage has been dropped or the case has been damaged, switch off the motor power and then disconnect the electronics power supply.

Contact your Newport service facility and request repairs.

WARNING

Do not attempt to modify this stage; this may cause an electric shock or downgrade its performance.

WARNING

Do not exceed the usable depth indicated on the mounting holes (see section “Dimensions”). Longer screws can damage the mechanics or cause a short-circuit.

WARNING

Do not exceed speed and load limitations as specified in this manual.

Caution

CAUTION

Do not place this stage in a hostile environment such as X-Rays, hard UV,... or in any vacuum environment.

CAUTION

Do not place this stage in a location affected by dust, oil fumes, steam or high humidity. This may cause an electric shock.

CAUTION

Do not leave this stage in places subject to extremely high temperatures or low temperatures. This may cause an electric shock.

- Operating temperature: +10 to +35 °C
 - Storage/Operating altitude: 1000 m
 - Storage/Operating humidity: 85%
 - Storage temperature: -10 to +40 °C (in its original packaging)
-

**CAUTION**

Do not move this stage if its motor power is on.

Make sure that the cable to the electronics is disconnected before moving the stage. Failure to do so may damage the cable and cause an electrical shock.

CAUTION

Be careful that the stage is not bumped when it is being carried. This may cause it to malfunction.

CAUTION

When handling this stage, always unplug the equipment from the power source for safety.

CAUTION

When the carriage is in its end-of-run position, it is strongly recommended not to go beyond this point as this may damage the stage mechanism.

CAUTION

Contact your Newport service facility to request cleaning and specification control every year.

Long Travel Industrial Linear Stages

IDL560-LM Series

1.0 Introduction

This manual provides operating instructions for the IDL560-LM stage that you have purchased.

RECOMMENDATION

Read and understand this user's manual before operating an IDL560-LM stage.

Inside this manual you will find useful information and technical references. It is recommended the user download all support documentation from the IDL560-LM page of the Newport website for reference.

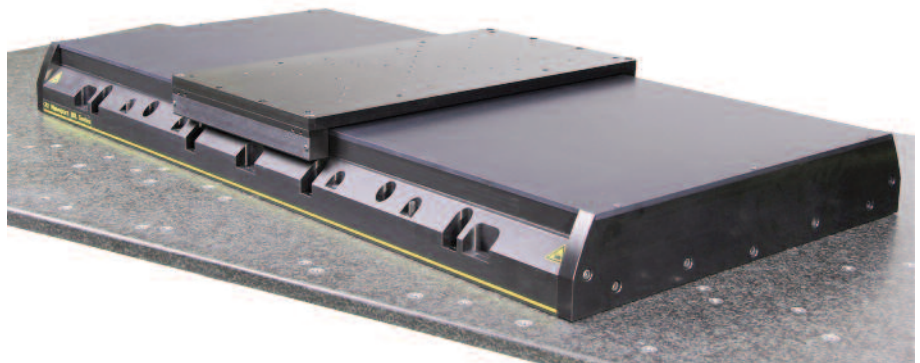

IDL560-600LM Stage.

RECOMMENDATION

We recommend you carefully read the chapter “Connection to electronics” before using the IDL560-LM stage.

2.0 Description

The IDL560-LM Series of Industrial-grade linear stages is another robust family of high quality Newport products, designed for higher throughput and reliability. This series is designed specifically for laser micro-machining applications that require high precision, down to 250 nm. Additional features for use in industrial environments include a hard top cover, flexible side bands and air purge.

Starting with an FEA-optimized body, recirculating bearings, high efficiency linear motor and a direct read linear encoder, all components were selected to enable the high precision and dynamic performance expected of high throughput and demanding applications. Other features include positive and negative end of runs to prevent overtravel, energy absorbers for unintended scenarios and an origin switch that can be used as a reference for absolute positioning.

Four sizes are offered to address a wide range of loads and travel.

2.1 Design Details

Base Material	Aluminum
Bearings	Recirculating caged ball bearings
Drive Mechanism	Ironless linear motor
Feedback	Linear steel scale with 20 μ m pitch
Limit Switches	Positive and Negative End-Of-Run -5 V
Origin	Optical at center of travel
Cable	4.5 m Connectorized, optional cable management

3.0 Characteristics

3.1 Definitions

Specifications of our products are established in reference to ISO 230 standard part II “Determination of accuracy and repeatability of positioning numerically controlled axes”.

This standard gives the definition of position uncertainty which depends on the 3 following parameters:

Absolute Accuracy

Difference between ideal position and real position.

Accuracy

Difference between ideal position and real position after the compensation of linear errors.

Linear errors include: cosine errors, inaccuracy of screw or linear scale pitch, angular deviation at the measuring point (Abbe error) and thermal expansion effects. All Newport motion electronics can compensate for linear errors.

The relation between absolute accuracy and on-axis accuracy is as follows:

$$\text{Absolute Accuracy} = \text{Accuracy} + \text{Correction Factor} \times \text{Travel}$$

Repeatability

Ability of a system to achieve a commanded position over many attempts.

Reversal Value (Hysteresis)

Difference between actual position values obtained for a given target position when approached from opposite directions.

Minimum Incremental Motion (MIM or Sensitivity)

The smallest increment of motion a device is capable of delivering consistently and reliably.

Resolution

The smallest increment that a motion device can theoretically move and/or detect. Resolution is not achievable, whereas MIM, is the real output of a motion system.

Yaw, Pitch

Rotation of carriage around the Z axis (Yaw) or Y axis (Pitch), when it moves.

The testing of accuracy, repeatability, and reversal error are made systematically with test equipment in controlled environment (20^{±1} °C).

A linear cycle with 21 data points on the travel and 4 cycles in each direction gives a total of 168 points.

Guaranteed and Typical Specifications

Guaranteed maximum performance values are verified per Newport's A167 metrology test procedure. For more information, please consult the metrology tutorial section in the Newport catalog or at www.newport.com

3.2 Mechanical Specifications



	IDL560-450LM	IDL560-600LM
Travel Range (mm)	450	600
Minimum Incremental Motion ⁽²⁾ (μm)		0.050
Bi-directional Repeatability ⁽¹⁾ (μm)		±0.10 (±0.25)
Typical (Guaranteed)		
Accuracy ⁽¹⁾ (μm)	(±2.5)	±1.5 (±3.0)
Typical (Guaranteed)		
Origin Repeatability (μm)		±0.1
Maximum Speed (mm/s)		2,000
Max. Acceleration (m/s ²)		30
Moving Mass (kg)		26
Pitch ⁽¹⁾⁽³⁾ , Guaranteed (μrad)	(±33)	(±40)
Yaw ⁽¹⁾⁽³⁾ , Guaranteed (μrad)	(±30)	(±30)
Straightness/Flatness	±7/±7	±8/±8
Normal Center Load Capacity [Cz] (N)		2,000
Axial Load, Continuous, [±Cx] (N)		393

¹⁾ For the definition of Typical and Guaranteed specifications see "Motion Basics Terminology & Standards" Tutorial at www.newport.com

²⁾ Driver dependent.

³⁾ To obtain arcsec units, divide μrad value by 4.8.

NOTE

The following specifications are controller/drive dependent. Refer to the IDL560-LM Series page on www.newport.com for specifications achievable with specific Newport controller/drive combination.

- MIM
- Accuracy
- Repeatability
- Max Speed
- Max Acceleration

3.3 Hard Stop: Speed Limitation Versus Load

IDL560-LM stages use electrical end-of-run and elastomer hard stops to stop the carriage as smoothly as possible past the end-of-runs. The overtravel allowed by the hard stops is 0.35 in. (9 mm).

When the stage is used with a controller supplied by Newport, the factory settings of the "software limits" prohibit any commanded motion beyond this travel range.

Nevertheless, for safety reasons, follow the recommendations above to minimize risk of mechanical damage, in case of failure or incorrect adjustment of parameters.

The maximum speed of the stage must be limited so that the hard stops will always stop the carriage in 0.35 in. (9 mm) or less, to avoid any shock between the carriage and stage body.

The graph at left, provides stage speed as a function of applied load. This curve defines allowed operating conditions to stop within the 0.35 in. (9 mm) over-travel allowed by the hard stops. To stop within this distance, the user must maintain speed and load within this tolerance. This graph assumes correct wiring of the electrical end of runs will cut motor power before contact with the hard stop.

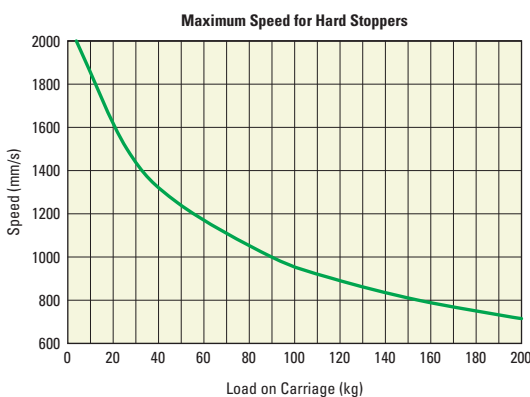

3.4 Load Characteristics and Stiffness

Normal Load Capacity (Cz)

Maximum load a stage can move while maintaining specifications.

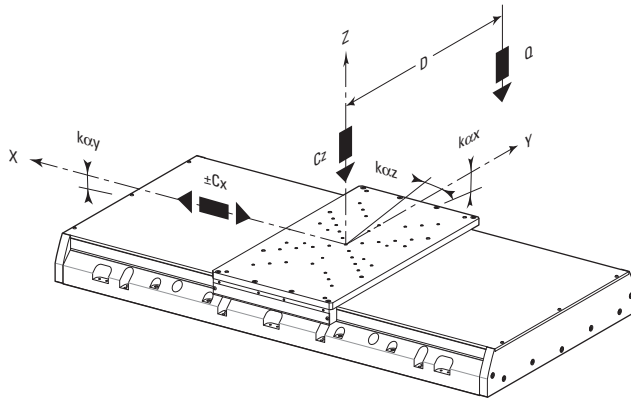

Cz, Normal center load capacity on bearings	2000 N
±Cx, Axial Load, Continuous	393 N
kαx, Angular stiffness (Roll)	0.15 μrad/Nm
kαy, Angular stiffness (Pitch)	0.4 μrad/Nm
kαz, Angular stiffness (Yaw)	0.1 μrad/Nm

Max. values for the normal center load (Cz) and the off-center load (Q) are given in the graphs below.

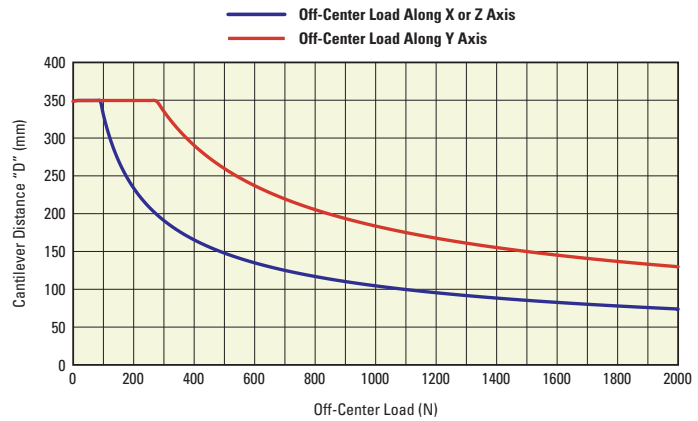

3.5 Stage Weights

The stage weights indicated below do not include the cables.

	Weight [lb (kg)]
IDL560-450LM	251.3 (114)
IDL560-600LM	273.4 (124)

4.0 Drive and Motor

4.1 Motor characteristics (Direct Drive Brushless Motor)

Continuous force, coil @ 100 °C	393 N
Continuous force, 3-bar Air Cooling, coil @ 100 °C	472 N
Peak force	2830 N
Motor constant	986 N ² /W
Continuous power	105 W
Peak power	5443 W
Electrical cycle	84 mm
Max. bus voltage	330 V
Max. coil temperature	125 °C
Thermal dissipation constant	2,1 W/°C
Continuous current	5.0 Arms
Continuous current, AC	6.0 Arms
Peak current	36.0 Arms
Force constant	78.6 N/Arms
Back-emf constant	64.2 V/m/s
Inductance	6.50 mH
Thermal resistance @ 25 °C	4.20 Ω
Electrical time constant	1.55 ms



CAUTION

High RMS current will generate motor heating which will degrade characteristics of the stage, such as repeatability, accuracy, etc...

4.2 Command Signals

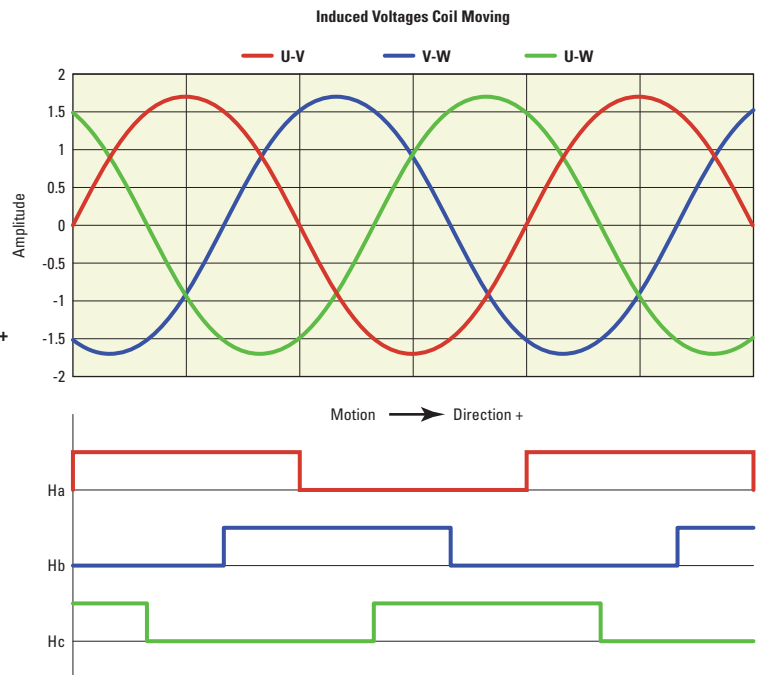
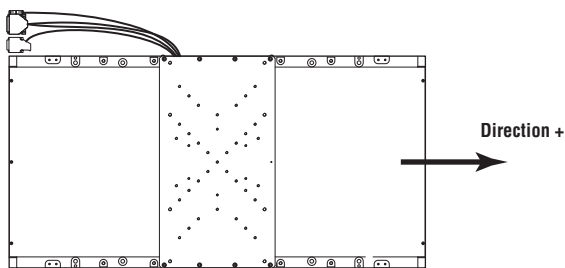

NOTE

The values above indicate voltage induced by energized coil of one phase on next phase coil. A positive value for U-V would indicate a higher voltage on U relative to V.

4.3 Sensor Positions

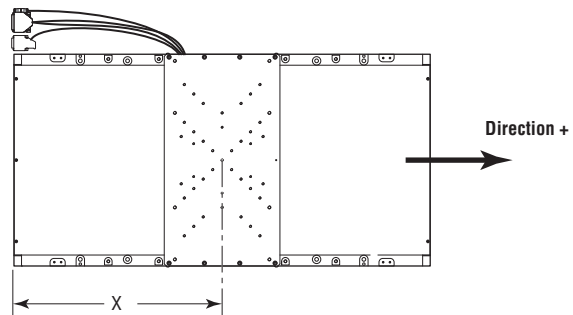
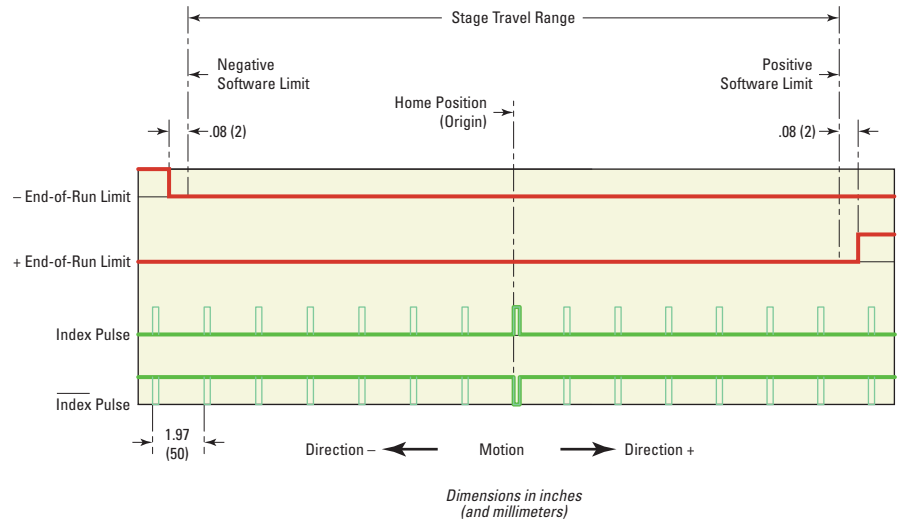

X Values [in. (mm)]	- Hard Stop	- End-of-Run Limit	Home Position	+ End-of-Run Limit	+ Hard Stop
IDL560-450LM	28.37 ⁰ _{-0.35} (270.5 ⁰ _{.9})	10.77 ^{+0.02} (273.5 ^{+0.5})	19.70 ^{+0.04} (500.5 ⁺¹)	28.64 ^{+0.02} (727.5 ^{+0.5})	28.76 ^{+0.35} (730.5 ⁺⁹ ₀)
IDL560-600LM	9.67 ⁰ _{-0.35} (245.5 ⁰ _{.9})	9.78 ^{+0.02} (248.5 ^{+0.5})	21.67 ^{+0.04} (550.5 ⁺¹)	33.56 ^{+0.02} (852.5 ^{+0.5})	33.68 ^{+0.35} (855.5 ⁺⁹ ₀)

4.4 Position Feedback Signals

Signal description/Voltage/Wiring	Heidenhain standard 1 Vpp
Reference mark position	see drawing "Sensor Positions"
Resolution	Scale pitch 20 μ m
Maximum speed	8 m/s

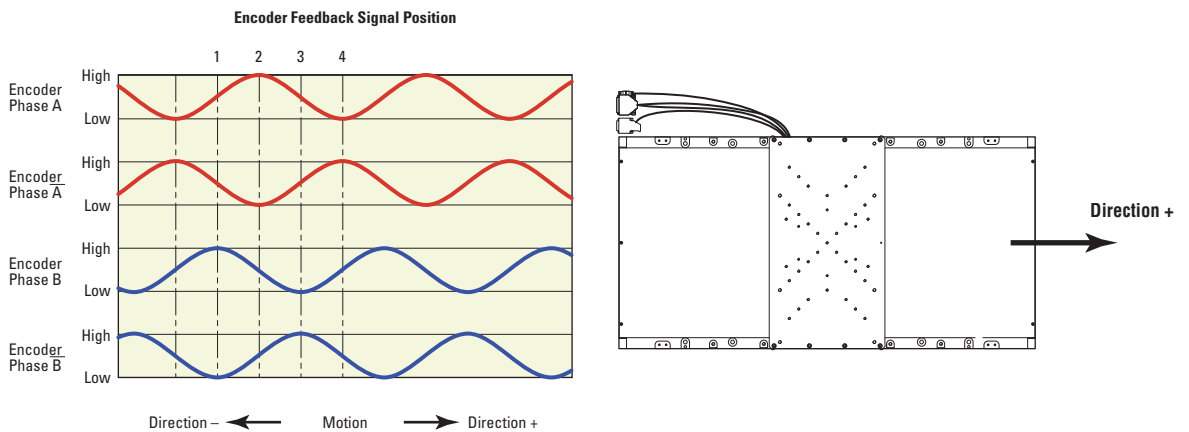

4.5 General Wiring

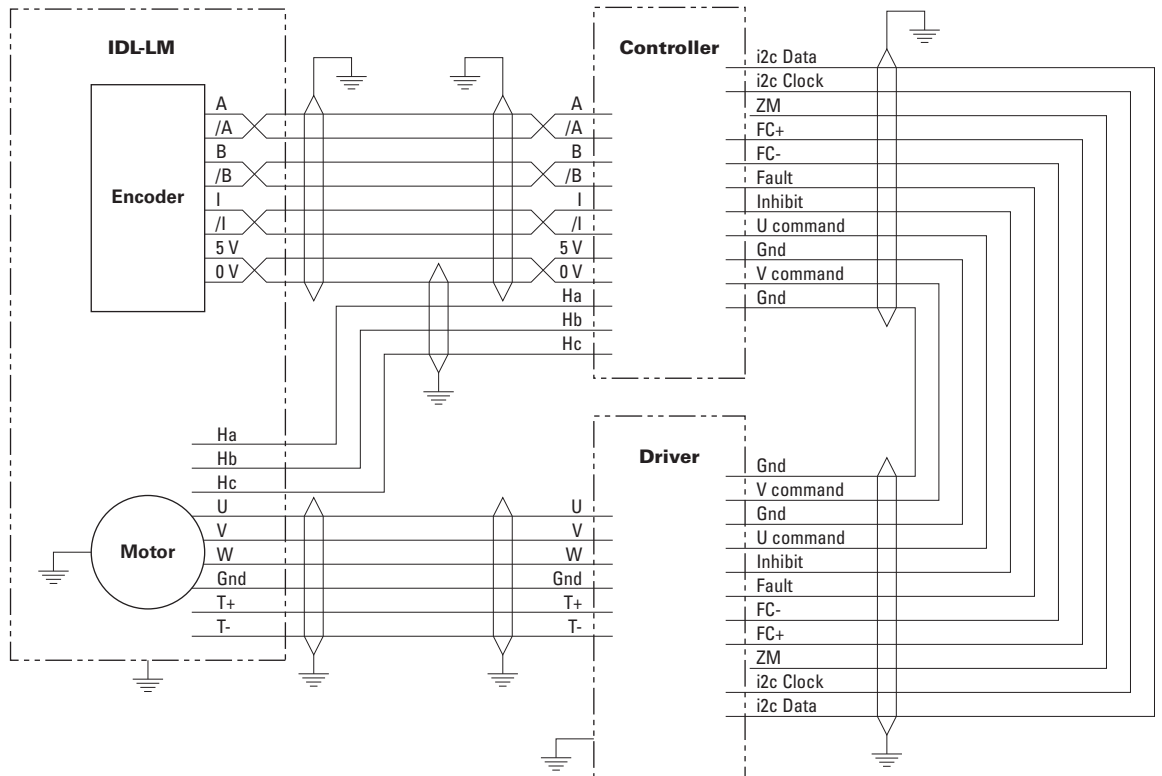

4.6 Pinouts

The pinout diagrams for IDL560-LM stage connectors are shown below.

4.6.1 Hall Effect Sensor (SUB-D15F Connector)

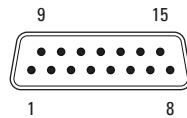

1	+5 V	9	N.C.
2	N.C.	10	N.C.
3	N.C.	11	N.C.
4	N.C.	12	N.C.
5	N.C.	13	N.C.
6	Ground	14	Hc
7	Ha	15	N.C.
8	Hb		

4.6.2 Encoder (SUB-D15M Connector)

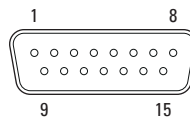

1	Encoder Phase B	9	Encoder Phase /B
2	Ground	10	Ground
3	Encoder Phase A	11	Encoder Phase /A
4	+5 V	12	N.C.
5	N.C.	13	N.C.
6	- End-of-Run	14	Index Pulse I
7	Index Pulse /I	15	N.C.
8	+ End-of-Run		

4.6.3 Encoder (SUB-D26HDM Connector on E5820A Adapter)

The E5820A adapter allows to connect the encoder cable with our XPS-D controller.

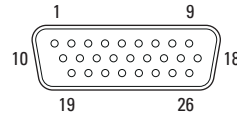

1	+5 V	14	+ End-of-Run
2	N.C.	15	Encoder Phase /A
3	N.C.	16	N.C.
4	Encoder Phase B	17	Index Pulse /I
5	- End-of-Run	18	N.C.
6	Encoder Phase A	19	N.C.
7	Ground	20	Ground
8	Index Pulse I	21	N.C.
9	N.C.	22	N.C.
10	N.C.	23	N.C.
11	N.C.	24	N.C.
12	N.C.	26	N.C.
13	Encoder Phase /B	26	N.C.

4.6.4 Motor (DB9W4M Connector)

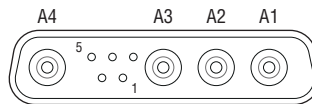

A1	Phase U Motor
A2	Phase V Motor
A3	Phase W Motor
A4	Ground + Shield
1	T+
2	T-
3	N.C.
4	N.C.
5	N.C.

4.7 IDL560-LM Cable Wirings

IDL560-LM stages are delivered equipped with the three cables required for operation. The wiring diagrams and connectors for these cables are provided below. When operating with non-Newport controllers, it is recommended to adhere to the wiring conventions presented here.

Hall Effect Sensor Cable

- Cable: Ø 3.3 mm
- Min. dynamic bending radius: 33 mm

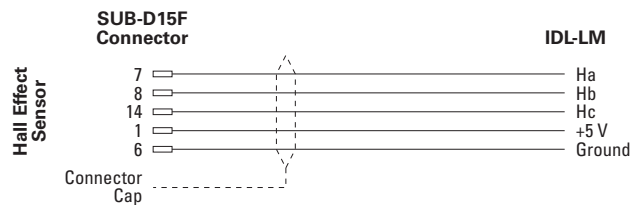

Encoder Cable

- Cable: Ø 4.25 mm
- Min. dynamic bending radius: 20 mm

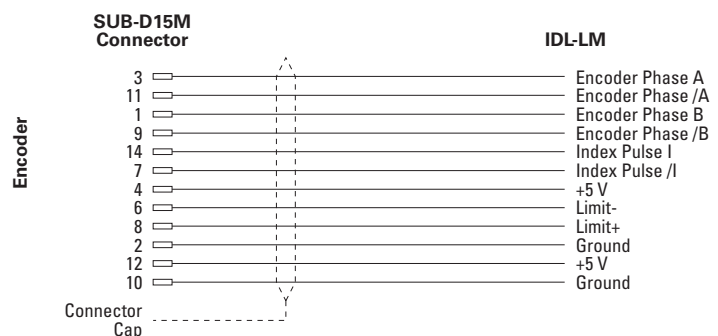

Motor Cable

- Cable: Ø 6 mm
- Min. dynamic bending radius: 60 mm

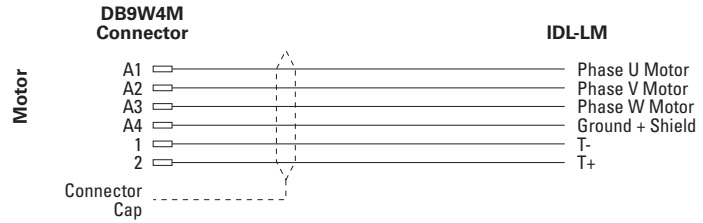

NOTE



A filter is supplied with each IDL560-LM stage. It can be used with an electronics other than the Newport XS-EDBL controller if the level of the noise is considered too high.

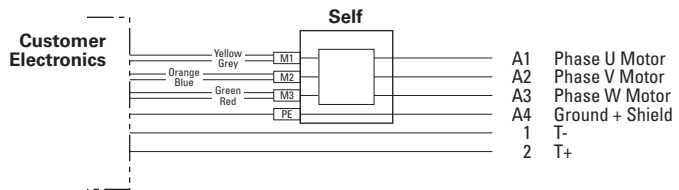

4.8 Air Tube

- Tube: ø.24 in. (6 mm) with Legris connector ref. 3606.06.00
- Min. dynamic bending radius: 27 mm

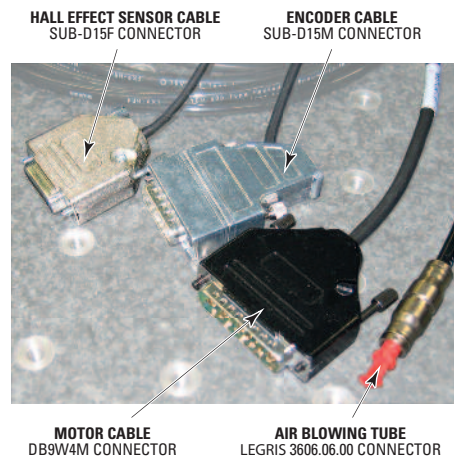

5.0 Stage Installation

5.1 Unpacking

The IDL560-LM stage will be delivered in packaging that is designed for safe transport. Attached to the body of the stage are lifting rings for safe removal from packaging. It is recommended to carefully lift and move the stage from packaging using these rings.

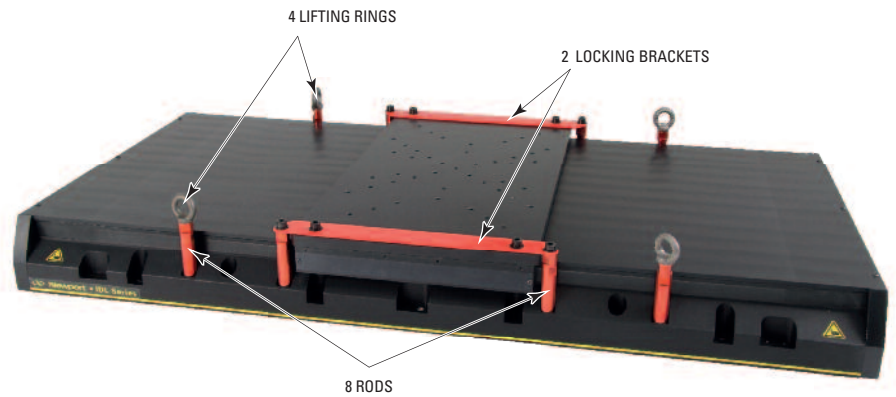

CAUTION

Using a beam, lift the lifting rods vertically, as slings with single point attachment (triangular shape) will induce side and bending loads to the IDL560-LM stage.

NOTE

Allen keys are supplied for CHc M6 and CHc M8 screws as well a 13-mm open-end wrench for dismantling the spacer tubes.

The stage will come with a control report that indicates performance of your stage within guaranteed specifications. These measurements were taken in a controlled environment and flat mounting conditions.

5.2 Setting Up

The IDL560-LM stage is equipped with lifting rings and 2 brackets to lock the carriage during transportation. To safely unpack the stage, follow the instructions below



CAUTION

Remove lifting and locking systems before using.

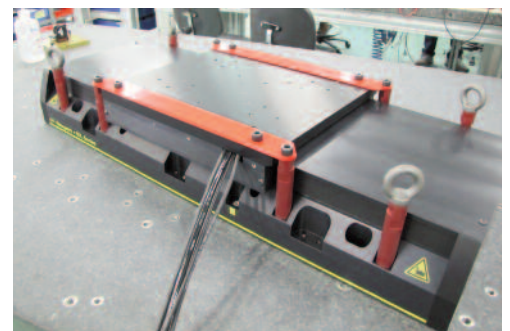

- ① Unscrew the lifting rings fixed on the rods.

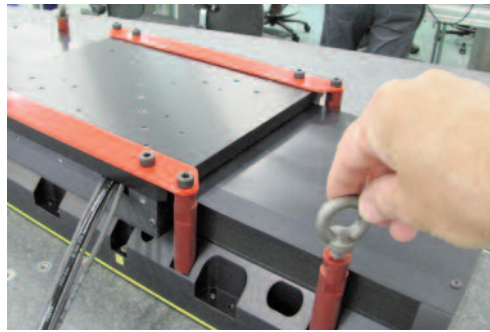

- ② Unscrew with the supplied Allen key, 4 CHc M8 screws from the 2 locking brackets on rods.

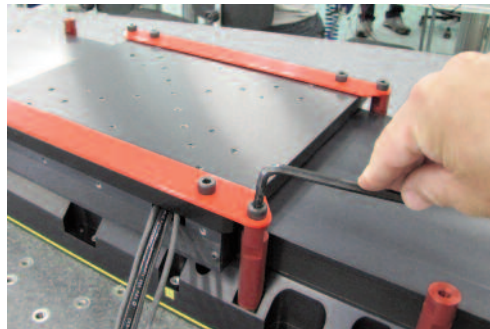

- ③ Unscrew with the supplied Allen key, 4 CHc M6 screws from the 2 locking brackets on the carriage.

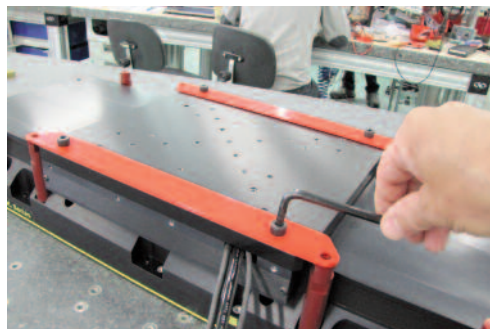

- ④ Remove the 2 locking brackets.

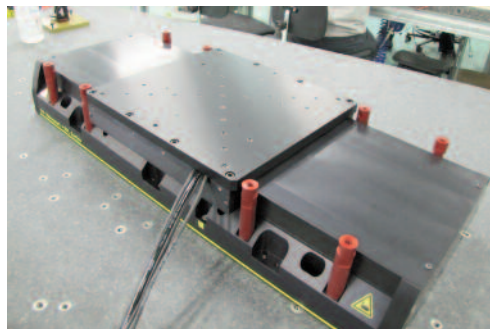

- ⑤ Unscrew and remove 8 mounting rods of the lifting rings and the locking plate.

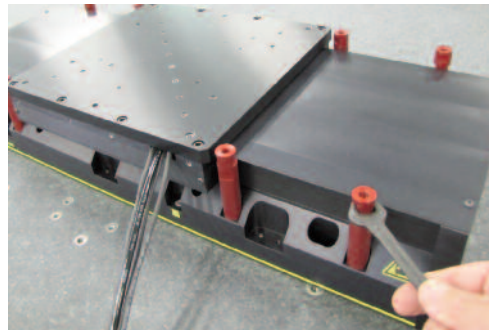

5.3 Mounting Conditions

IDL560-LM stages feature an eight-point mounting pattern which is ideal for non-flat surfaces. However it is recommended for all IDL560-LM stages that the following mounting conditions be adhered to for best performance and security.

Installation Considerations

	<400 mm Travel	<800 mm Travel
Mounting surface flatness	10 μm	15 μm
Payload surface flatness	20 μm	20 μm
Mounting Screw torque		M8: 16.0 Nm M6: 7.0 Nm M5: 4.1 Nm M4: 2.1 Nm

5.4 Air Blowing

When used in dusty environment (dust, debris...), the stage can be protected by connecting an air source to the air tube plug (see sections 4.8 & 8.0 of this manual). This will prevent pollution from coming in by slightly increasing stage internal pressure. Such air injection can also be used to improve motor heat dissipation and limit temperature increase.



Here are the required characteristics for the air source:

- Pressure: 6.0 bars
- Particle size: 5 μm
- Particle density: 5 mg/m^3
- Dew point: $-20\text{ }^\circ\text{C}$
- Gas Oil ratio: 1 mg/m^3

6.0 Connection to Newport Controllers

6.1 Warnings on Controllers

Controllers are intended for use by qualified personnel who recognize shock hazards and are familiar with safety precautions required to avoid possible injury. Read the controller user's manual carefully before operating the instrument and pay attention to all written warnings and cautions.

WARNING

Disconnect the power plug under the following circumstances:

- If the power cord or any attached cables are frayed or damaged in any way.
- If the power plug is damaged in any way.
- If the unit is exposed to rain, excessive moisture, or liquids are spilled on the unit.
- If the unit has been dropped or the case is damaged.
- If you suspect service or repair is required.
- Whenever you clean the electronics unit.

CAUTION

To protect the unit from damage, be sure to:

- Keep all air vents free of dirt and dust.
- Keep all liquids away from the unit.
- Do not expose the unit to excessive moisture (85% humidity).
- Read this manual before using the unit for the first time.



WARNING

All attachment plug receptacles in the vicinity of this unit are to be of the grounding type and properly polarized.

Contact your electrician to check your receptacles.

WARNING

This product is equipped with a 3-wire grounding type plug.

Any interruption of the grounding connection can create an electric shock hazard.

If you are unable to insert the plug into your wall plug receptacle, contact your electrician to perform the necessary alterations to ensure that the green (green-yellow) wire is attached to earth ground.

WARNING

This product operates with voltages that can be lethal.

Pushing objects of any kind into cabinet slots or holes, or spilling any liquid on the product, may touch hazardous voltage points or short out parts.

6.2 Connection

There is a label on every stage indicating its part and serial numbers.



WARNING

Always turn the controller's power OFF before connecting a stage.

NOTE

Supplied cables are compatible with Newport controllers. For more information, please contact your sales representative.

6.3 Cables

IDL560-LM stages are delivered with three 4.5-meter cables that can be directly connected to the Newport controller.

WARNING

IDL560-LM Series translation stages can only operate with cable lengths of 4.5 m or less.



WARNING

These cables are shielded. For correct operation, make sure to lock connectors (ground continuity provided by cables).

WARNING

Keep the cables at a safe distance from other electrical cables in your environment to avoid potential cross talk.

6.4 Adapter for the XPS-D Newport Controller

The E5820A adapter supplied with each IDL225-LM stage, allows the connection of the encoder cable with our XPS-D controller.



7.0 Connection to Non-Newport Controllers

Newport stages can be operated with Non-Newport controllers. However, under such operating conditions Newport makes no guarantee regarding achievable specifications. To aid Newport customers using non-Newport Controllers with IDL560-LM Series stages, wiring conventions and motor characteristics are provided. It should be noted, damage caused by improper configuration or operation while in use with non-Newport controllers is not covered by the warranty.

Please refer to the Design Details and Specifications for more information to help configure the stage with your controller. Newport also provides a tech note on configuring third party stages with Newport controllers in the IDL560-LM website, which may be useful as a reference.

WARNING

Newport is not responsible for malfunction or damage of IDL165-LM stages when used with non-Newport controllers.

It is the customer's responsibility to modify the cable and take care of sensor signal connections, when using the stage with non-Newport controllers.



- **The End-of-Run signal is open collector type. It supports up to 30 V and 10 mA.**

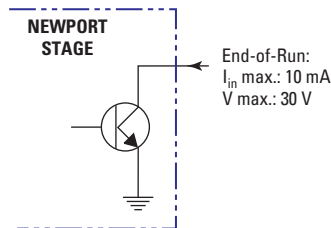

WARNING

- **Maximum peak voltage: 330 V_{peak}**
- **Maximum rms current: 5 Arms without air cooling
6 Arms with 3-bar air cooling**

8.0 Dimensions

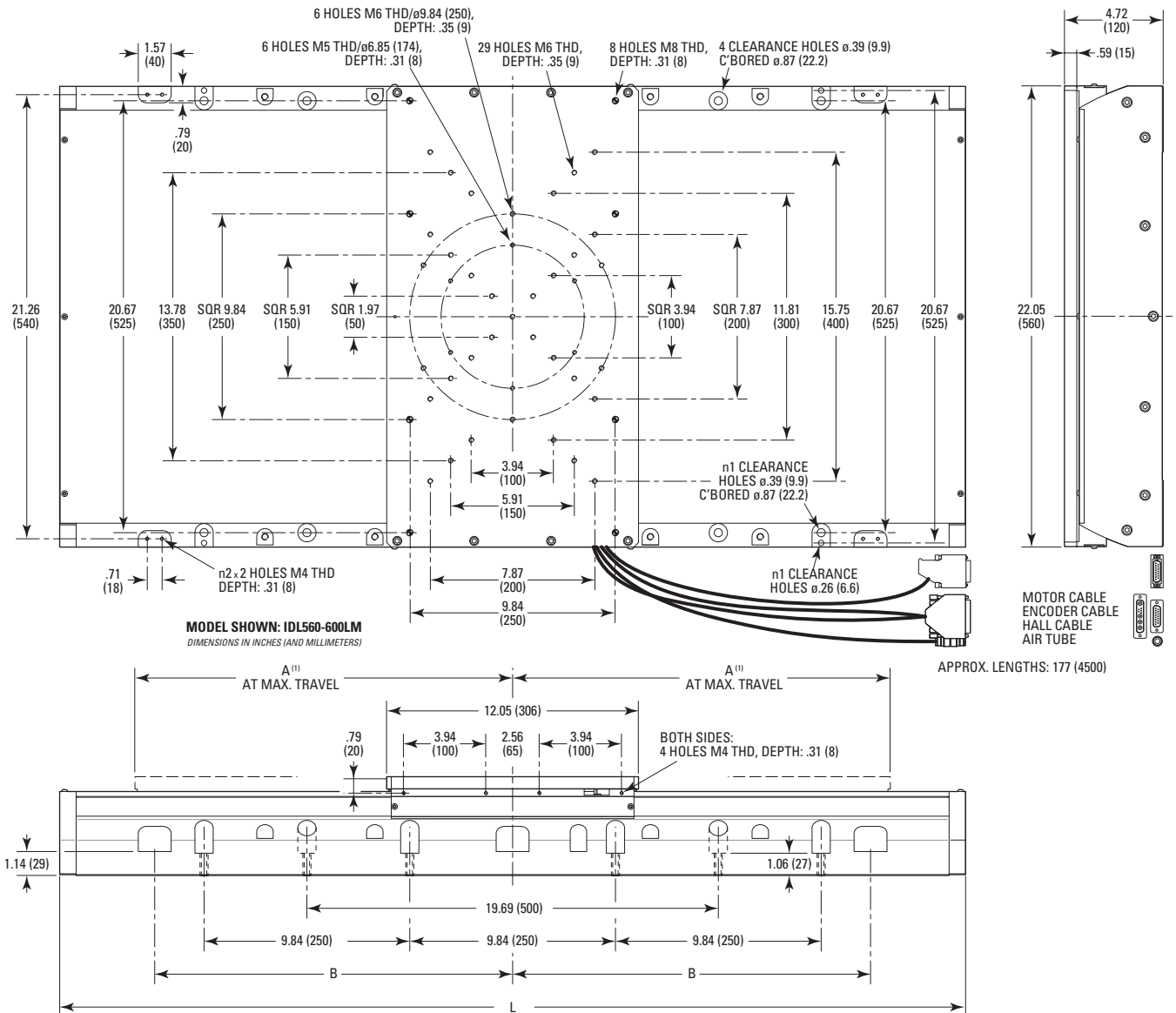

MODEL	TRAVEL	L	A ⁽¹⁾	n1	B	n2
IDL560-450LM	17.72 (450)	39.41 (1001)	15.43 (392)	8	8.07 (205)	6
IDL560-600LM	23.62 (600)	43.35 (1101)	18.39 (467)	8	17.13 (435)	6

⁽¹⁾ INCLUDING OVER-TRAVEL ALLOWED BY THE HARD STOP.

9.0 Maintenance

RECOMMENDATION

Please contact Technical Sales Support team for recommendations on application specific maintenance.

9.1 Maintenance

The IDL560-LM stage requires no particular maintenance. Nevertheless, this is a precision mechanical device that must be kept and operated with caution.

NOTE

A slight wear is visible on protective sidebands the first 100 hours approximately.

These sidebands have been extensively tested, and this change of appearance does not lead damage or service life limitation.

PRECAUTIONS

The IDL560-LM stage must be used or stocked in a clean environment, without dust, humidity, solvents or other substances.

RECOMMENDATION

It is recommended to return the stage to Newport for re-lubrication after 2000 hours of use.

If the IDL560-LM stage is mounted on a workstation and cannot be easily removed, please contact Newport's After Sales Service for further instructions.

9.2 Repair

CAUTION



Never attempt to disassemble a component of the stage that has not been covered in this manual.

To disassemble a non specified component can cause a malfunction of the stage.

If you observe a malfunction in your stage, please contact us immediately to arrange for a repair.



CAUTION

Any attempt to disassemble or repair a stage without prior authorization will void your warranty.

9.3 Calibration



CAUTION

It is recommended to return your IDL560-LM stage to Newport once a year for recalibration to its original specifications.



Visit Newport Online at:
www.newport.com

North America & Asia

Newport Corporation
1791 Deere Ave.
Irvine, CA 92606, USA

Sales

Tel.: (800) 222-6440
e-mail: sales@newport.com

Technical Support

Tel.: (800) 222-6440
e-mail: tech@newport.com

Service, RMAs & Returns

Tel.: (800) 222-6440
e-mail: service@newport.com

Europe

MICRO-CONTROLE Spectra-Physics S.A.S
9, rue du Bois Sauvage
91055 Évry CEDEX
France

Sales & Technical Support

Tel.: +33 (0)1.60.91.68.68
e-mail: france@newport.com

Service & Returns

Tel.: +33 (0)2.38.40.51.55



 Newport®  Ophir®  Spectra-Physics®