

Model 8742

Picomotor™ Controller/Driver



User's Manual



EU27 DECLARATION OF CONFORMITY

Application of Council Directive(s):

- Electromagnetic Compatibility Directive (EMCD) – 2014/30/EU
- Low Voltage Directive (LVD) – 2014/35/EU
- Restriction of Hazardous Substances Directive (RoHS2) – 2011/65/EU ⁽²⁾
- Restriction of Hazardous Substances Directive (RoHS3) – (EU) 2015/863 ⁽²⁾
- Waste Electrical and Electronic Equipment – Directive 2012/19/EU



Standard(s) to which conformity is declared:

- EN 61326-1:2013 – (EMC)
- EN 61010-1:2010 + AMD 1:2016 (Ed 3) – (Safety)

Emissions:

- CISPR 11:2015 Industrial, Scientific and Medical Equipment Radio-Frequency Disturbance Characteristics - Limits and Methods of Measurement
- IEC 61000-3-2:2018 EMC/Limits for Harmonic Current Emission ⁽¹⁾
- IEC 61000-3-3:2013 + AMD1:2017 EMC/Limitations of Voltage Fluctuations and Flicker in Low-Voltage Supply Systems ⁽¹⁾

Immunity:

- IEC 61000-4-2:2008 EMC/Electrostatic Discharge Immunity Test
- IEC 61000-4-3:2006+AMD1:2007+AMD2:2010 EMC/Radiated Radio - Frequency Electromagnetic Field Immunity Test
- IEC 61000-4-4:2012 EMC/Electrical Fast Transient/Burst Immunity Test
- IEC 61000-4-5:2014 + AMD 1:2017 EMC/Surge Immunity Test ⁽¹⁾
- IEC 61000-4-6:2013 EMC/Conducted Disturbances induced by Radio Frequency Fields Immunity Test
- IEC 61000-4-8:2009 EMC/Power Frequency Magnetic Field Immunity Test
- IEC 61000-4-11:2004 + AMD 1:2017 EMC/Voltage Dips, Short Interruptions and Variations Immunity Test ⁽¹⁾

Manufacturers Name: MKS Instruments, Inc., 2 Tech Drive, Andover, MA 01810 USA

Authorized Representatives Name & Location: MICRO-CONTROLE Spectra-Physics S.A.S., Zone Industrielle, 45340 Beaune la Rolande, France

Equipment Type/Description: Electrical equipment for measurement, control and laboratory use

Model Number(s) ⁽¹⁾: 8742, 8742-VariouS

The object of the declaration described above is in conformity with the relevant Community harmonization legislation. MKS product conforms to the above Directive(s) and Standard(s) only when installed in accordance with manufacturer's specifications. This declaration has been issued under the sole responsibility of the manufacturer.

Date: 1/5/2021

Signature:

Full Name: **Le Cointe Hervé**

Title: Quality director

-
- 1) Compliance of the above model numbers requires the use of a braided shielded cable properly terminated at both ends – if so noted in the MKS Instruction Manual.
 - 2) RoHS Directive has to be checked for in scope products; cannot CE mark without compliance to RoHS. RoHS Directive can be unchecked only for systems which MKS sells which qualify for “Large Scale Industrial Tool” exclusion.

UK DECLARATION OF CONFORMITY

Application of Council Directive(s):

- Electromagnetic Compatibility Directive (EMCD) – 2014/30/EU
- Low Voltage Directive (LVD) – 2014/35/EU
- Restriction of Hazardous Substances Directive (RoHS2) – 2011/65/EU ⁽²⁾
- Restriction of Hazardous Substances Directive (RoHS3) – (EU) 2015/863 ⁽²⁾
- Waste Electrical and Electronic Equipment – Directive 2012/19/EU



Standard(s) to which conformity is declared:

- BS EN 61326-1:2013 – (EMC)
- BS EN 61010-1:2010 + AMD 1:2016 (Ed 3) – (Safety)

Emissions:

- CISPR 11:2015 Industrial, Scientific and Medical Equipment Radio-Frequency Disturbance Characteristics - Limits and Methods of Measurement
- IEC 61000-3-2:2018 EMC/Limits for Harmonic Current Emission ⁽¹⁾
- IEC 61000-3-3:2013 + AMD1:2017 EMC/Limitations of Voltage Fluctuations and Flicker in Low-Voltage Supply Systems ⁽¹⁾

Immunity:

- IEC 61000-4-2:2008 EMC/Electrostatic Discharge Immunity Test
- IEC 61000-4-3:2006+AMD1:2007+AMD2:2010 EMC/Radiated Radio - Frequency Electromagnetic Field Immunity Test
- IEC 61000-4-4:2012 EMC/Electrical Fast Transient/Burst Immunity Test
- IEC 61000-4-5:2014 + AMD 1:2017 EMC/Surge Immunity Test ⁽¹⁾
- IEC 61000-4-6:2013 EMC/Conducted Disturbances induced by Radio Frequency Fields Immunity Test
- IEC 61000-4-8:2009 EMC/Power Frequency Magnetic Field Immunity Test
- IEC 61000-4-11:2004 + AMD 1:2017 EMC/Voltage Dips, Short Interruptions and Variations Immunity Test ⁽¹⁾

Manufacturers Name: MKS Instruments, Inc., 2 Tech Drive, Andover, MA 01810 USA

Authorized Representatives Name & Location: MICRO-CONTROLE Spectra-Physics S.A.S., Zone Industrielle, 45340 Beaune la Rolande, France

Equipment Type/Description: Electrical equipment for measurement, control and laboratory use

Model Number(s) ⁽¹⁾: 8742, 8742-VariouS

The object of the declaration described above is in conformity with the relevant Community harmonization legislation. MKS product conforms to the above Directive(s) and Standard(s) only when installed in accordance with manufacturer's specifications. This declaration has been issued under the sole responsibility of the manufacturer.

Date: 1/5/2021

Signature:

Full Name: **Le Cointe Hervé**

Title: Quality director

-
- 1) Compliance of the above model numbers requires the use of a braided shielded cable properly terminated at both ends – if so noted in the MKS Instruction Manual.
 - 2) RoHS Directive has to be checked for in scope products; cannot UKCA mark without compliance to RoHS. RoHS Directive can be unchecked only for systems which MKS sells which qualify for "Large Scale Industrial Tool" exclusion.

Warranty

New Focus warrants that this product will be free from defects in material and workmanship and will comply with New Focus's published specifications at the time of sale for a period of one year from date of shipment. If found to be defective during the warranty period, the product will either be repaired or replaced at New Focus's option.

To exercise this warranty, write or call your local New Focus office or representative, or contact Newport headquarters in Irvine, California. You will be given prompt assistance and return instructions. Send the product, freight prepaid, to the indicated service facility. Repairs will be made and the instrument returned freight prepaid. Repaired products are warranted for the remainder of the original warranty period or 90 days, whichever first occurs.

Limitation of Warranty

The above warranties do not apply to products which have been repaired or modified without New Focus's written approval, or products subjected to unusual physical, thermal or electrical stress, improper installation, misuse, abuse, accident or negligence in use, storage, transportation or handling. This warranty also does not apply to fuses, batteries, or damage from battery leakage.

THIS WARRANTY IS IN LIEU OF ALL OTHER WARRANTIES, EXPRESSED OR IMPLIED, INCLUDING ANY IMPLIED WARRANTY OF MERCHANTABILITY OR FITNESS FOR A PARTICULAR USE. NEW FOCUS SHALL NOT BE LIABLE FOR ANY INDIRECT, SPECIAL, OR CONSEQUENTIAL DAMAGES RESULTING FROM THE PURCHASE OR USE OF ITS PRODUCTS.

First printing 2017

© 2017 by New Focus, Santa Clara, CA. All rights reserved. No part of this manual may be reproduced or copied without the prior written approval of New Focus.

This manual has been provided for information only and product specifications are subject to change without notice. Any change will be reflected in future printings.

New Focus
3635 Peterson Way
Santa Clara, CA, 95054
USA

Part No. 90066734 Rev. G

Confidentiality & Proprietary Rights

Reservation of Title

The New Focus programs and all materials furnished or produced in connection with them ("Related Materials") contain trade secrets of New Focus and are for use only in the manner expressly permitted. New Focus claims and reserves all rights and benefits afforded under law in the Programs provided by New Focus.

New Focus shall retain full ownership of Intellectual Property Rights in and to all development, process, align or assembly technologies developed and other derivative work that may be developed by New Focus. Customer shall not challenge, or cause any third party to challenge the rights of New Focus.

Preservation of Secrecy and Confidentiality and Restrictions to Access

Customer shall protect the New Focus Programs and Related Materials as trade secrets of New Focus, and shall devote its best efforts to ensure that all its personnel protect the New Focus Programs as trade secrets of New Focus. Customer shall not at any time disclose New Focus's trade secrets to any other person, firm, organization, or employee that does not need (consistent with Customer's right of use hereunder) to obtain access to the New Focus Programs and Related Materials. These restrictions shall not apply to information (1) generally known to the public or obtainable from public sources; (2) readily apparent from the keyboard operations, visual display, or output reports of the Programs; 3) previously in the possession of Customer or subsequently developed or acquired without reliance on the New Focus Programs; or (4) approved by New Focus for release without restriction.

Trademarks

The New Focus logo and name are registered trademarks of Newport Corporation in Mexico, Israel, Singapore, European Union, Taiwan, Hong Kong, China, Japan, Korea, Canada, Australia, and the United States.

Service Information

This section contains information regarding factory service for the source. The user should not attempt any maintenance or service of the system or optional equipment beyond the procedures outlined in this manual. Any problem that cannot be resolved should be referred to New Focus.

Technical Support Contacts

North America

New Focus

3635 Peterson Way, Santa Clara, CA 95054

Telephone: (866) 683-6287

Telephone: (408) 919-1500

Asia

Newport Opto-Electronics Technologies

中国 上海市 爱都路 253号 第3号楼 3层

C部位, 邮编 200131

253 Aidu Road, Bld #3, Flr 3, Sec C,
Shanghai 200131, China

Telephone: +86-21-5046 2300

Fax: +86-21-5046 2323

Europe

Newport/MICRO-CONTROLE S.A.

Zone Industrielle

45340 Beaune la Rolande, FRANCE

Telephone: (33) 02 38 40 51 56

Newport Corporation Calling Procedure

If there are any defects in material or workmanship or a failure to meet specifications, promptly notify Newport's Returns Department by calling 1-800-222-6440 or by visiting our website at www.newport.com/returns within the warranty period to obtain a **Return Material Authorization Number (RMA#)**. Return the product to Newport Corporation, freight prepaid, clearly marked with the RMA# and we will either repair or replace it at our discretion. Newport is not responsible for damage occurring in transit and is not obligated to accept products returned without an RMA#.

E-mail: rma.service@newport.com

When calling New Focus Corporation, please provide the customer care representative with the following information:

Your Contact Information

Serial number or original order number

Description of problem (i.e., hardware or software)

To help our Technical Support Representatives diagnose your problem, please note the following conditions:

Is the system used for manufacturing or research and development?

What was the state of the system right before the problem?

Have you seen this problem before? If so, how often?

Can the system continue to operate with this problem? Or is the system non-operational?

Can you identify anything that was different before this problem occurred?

Table of Contents

EU27 DECLARATION OF CONFORMITY	ii
UK DECLARATION OF CONFORMITY	iii
Warranty.....	iv
Technical Support Contacts	vi
Table of Contents	vii
List of Figures	x

1 Safety Precautions 11

1.1 Definitions and Symbols	11
1.1.1 General Warning or Caution	11
1.1.2 Electric Shock.....	11
1.1.3 Potential Burn Hazard	11
1.1.4 European Union CE Mark	12
1.1.5 UKCA Mark	12
1.1.6 Alternating voltage symbol	12
1.1.7 On	12
1.1.8 Off.....	12
1.1.9 Ground.....	13
1.1.10 DC Symbol	13
1.1.11 Waste Electrical and Electronic Equipment (WEEE)	13
1.1.12 Control of Hazardous Substances.....	13
1.2 Warnings and Cautions.....	14
1.2.1 General Warnings.....	14
1.2.2 General Cautions	15
1.2.3 Summary of Warnings and Cautions.....	15
1.3 Location of Labels and Warnings.....	18
1.4 Safety Grounding Considerations.....	19

2 General Information 21

2.1 System Overview.....	21
2.2 Scope of this Manual	22
2.3 Unpacking and Inspection	22
2.3.1 What is included	22
2.4 Available accessories.....	22
2.5 Safety	23
2.6 Specifications	24

2.6.1	Operating Limits*	24
2.6.2	Weight, Dimensions	25
3	Theory of Operation	26
3.1	How the Picomotor Actuator Works	26
3.2	Stepping the Picomotor with the 8742 Controller/Driver	26
3.3	Status Indicator	27
3.4	Power Supply	28
3.4.1	Fault Protection	28
3.5	Input / Output Connections	29
3.5.1	USB	30
3.5.2	Ethernet	30
3.5.3	RS-485	30
3.5.4	Power	30
3.5.5	Picomotor Interfaces	30
3.6	Mounting the unit	31
4	Initial Setup	32
4.1	Introduction	32
4.2	Grounding	32
4.3	Power	32
4.4	Connecting 8742 to a Computer via USB	32
4.5	Connecting 8742 to a Computer via Ethernet	33
4.5.1	Connecting to a Router	33
4.6	Picomotor Connections	33
4.7	Connecting Multiple Units to a Computer	34
4.7.1	Using USB Hubs	35
4.7.2	Using Ethernet Routers/Switchers	36
4.7.3	Using RS-485 LAN to Daisy-Chain	37
4.8	Connecting to the 8758 Hand Control Pad	39
5	Computer Interfacing	41
5.1	Introduction	41
5.2	Computer Interface Terminology	41
5.3	USB Communication	41
5.3.1	USB Command Termination	42
5.4	Ethernet Communication	42
5.4.1	Ethernet Dynamic and Static IP Address Setup	43

5.4.2	Using a Static IP Address	43
5.4.3	Ethernet Peer-to-Peer Cabling	46
5.4.4	Communicating Using a Hostname	46
5.5	RS-485 Communication	47
5.5.1	Setting up an RS-485 Network	48
5.5.2	Communication with a Slave Controller	49
5.6	Picomotor Controller Software Application	50
5.6.1	Introduction	50
5.6.2	Overview	51
5.6.3	Embedded Dynamic HTTP Server	62
5.7	LabVIEW™ and C# Programming Support	63
5.7.1	Introduction	63
6	Remote Command Set	64
6.1	Command Syntax	64
6.1.1	RS-485 Command Syntax	65
6.1.2	Summary of Command Syntax	66
6.2	Command List	67
6.2.1	Description of Commands	69
7	Appendix	97
7.1	Non Axis-Specific Error Messages	97
7.2	Axis-Specific Error Messages	98
8	Maintenance and Service	100
8.1	Enclosure Cleaning	100
8.2	Technical Support	100
8.3	Service	101
8.4	Obtaining Service	101
8.5	Warranty	101
8.6	Service Form	102

List of Figures

Figure 1	General Warning or Caution Symbol	11
Figure 2	Electrical Shock Symbol.....	11
Figure 3	Hot Surface Symbol.....	11
Figure 4	CE Mark.....	12
Figure 5	UKCA Mark.....	12
Figure 6	Alternating Voltage Symbol	12
Figure 7	On Symbol	12
Figure 8	Off Symbol.....	12
Figure 9	Ground Symbol.....	13
Figure 10	DC Symbol.....	13
Figure 11	WEEE Directive Symbol	13
Figure 12	RoHS Compliant Symbol	13
Figure 13	Labels and Warnings.....	18
Figure 14	Status Indicators position.....	27
Figure 15	Heatsink mounting slots.....	29
Figure 16	8742 Inputs and Outputs	29
Figure 17	L-bracket	34
Figure 18	Using L-brackets to stack up several Controllers	34
Figure 19	Connecting four units to a computer via a USB hub	35
Figure 20	Connecting three units to a computer via an Ethernet router.....	36
Figure 21	Connecting four units to a computer via RS-485 LAN	37
Figure 22	Connecting four units to a computer via RS-485 adapter.....	38
Figure 23	Single Controller Setup.....	39
Figure 24	Multiple Controller Setup	40
Figure 25	Picomotor Controller RS-485 LAN Topology	48
Figure 26	Picomotor Application Software.....	50
Figure 27	Controller Address Identification	51
Figure 28	Jog Tab.....	52
Figure 29	Cycle Tab	53
Figure 30	Terminal Tab.....	54
Figure 31	Controller Setup Window	55
Figure 32	Ethernet Setup Window	56
Figure 33	Options Window	57
Figure 34	Properties Window.....	58
Figure 35	Controller Scan	59
Figure 36	Address Conflict Resolution Window	60
Figure 37	Device Address Window	61
Figure 38	Internet Browser View	62
Figure 39	Command Syntax Diagram.....	64

1 Safety Precautions

1.1 Definitions and Symbols

The following terms and symbols are used in this documentation and also appear on the Model 8742 Controller/Driver where safety-related issues occur.

1.1.1 General Warning or Caution



Figure 1 *General Warning or Caution Symbol*

The Exclamation Symbol in the figure above appears on the product and in Warning and Caution tables throughout this document. This symbol designates that documentation needs to be consulted to determine the nature of a potential hazard, and any actions that have to be taken.

1.1.2 Electric Shock



Figure 2 *Electrical Shock Symbol*

The Electrical Shock Symbol in the figure above appears throughout this manual and on the product. This symbol indicates a hazard arising from dangerous voltage. Any mishandling could result in irreparable damage to the equipment, and personal injury or death.

1.1.3 Potential Burn Hazard



Figure 3 *Hot Surface Symbol*

The Hot Surface Symbol in the figure above appears throughout this manual and on the product. This symbol indicates a hazard arising from a high temperature. Any mishandling could result in personal injury.

1.1.4 European Union CE Mark



Figure 4 *CE Mark*

The presence of the CE Mark on New Focus equipment means that this instrument has been designed, tested and certified compliant to all applicable European Union (CE) regulations and recommendations.

1.1.5 UKCA Mark



Figure 5 *UKCA Mark*

The presence of the UKCA Mark on New Focus equipment means that this instrument has been designed, tested and certified compliant to all applicable United Kingdom regulations and recommendations.

1.1.6 Alternating voltage symbol



Figure 6 *Alternating Voltage Symbol*

This international symbol implies an alternating voltage or current.

1.1.7 On



Figure 7 *On Symbol*

The symbol in the figure above represents a power switch position on a Model 8742. This symbol represents a Power On condition.

1.1.8 Off



Figure 8 *Off Symbol*

The symbol in the figure above represents a power switch position on the Model 8742. This symbol represents a Power Off condition.

1.1.9 Ground



Figure 9 *Ground Symbol*

The symbol in the figure above appears on the Model 8742 to indicate the screw to be used to ground the case of the unit. This symbol identifies the frame or chassis terminal.

1.1.10 DC Symbol



Figure 10 *DC Symbol*

This international symbol implies an unvarying current or voltage.

1.1.11 Waste Electrical and Electronic Equipment (WEEE)



Figure 11 *WEEE Directive Symbol*

This symbol on the product or on its packaging indicates that this product must not be disposed with regular waste. Instead, it is the user responsibility to dispose of waste equipment according to the local laws. The separate collection and recycling of the waste equipment at the time of disposal will help to conserve natural resources and ensure that it is recycled in a manner that protects human health and the environment. For information about where the user can drop off the waste equipment for recycling, please contact your local New Focus representative.

1.1.12 Control of Hazardous Substances



Figure 12 *RoHS Compliant Symbol*

This label indicates the products comply with the EU Directive 2002/95/EC that restricts the content of six hazardous chemicals.

1.2 Warnings and Cautions

The Model 8742 is a component of a system that will contain one or more Picomotors and other items. Since New Focus cannot control these other system components, the User is ultimately responsible for ensuring that the complete system meets all applicable product and workplace safety regulations. Specific attention should be directed to the description of safety grounding concerns described in Section 1.4, below.

The following are definitions of the Warnings, Cautions and Notes that are used throughout this manual to call your attention to important information regarding your safety, the safety and preservation of your equipment or an important tip.

	WARNING Situation has the potential to cause bodily harm or death.
-----------------------------------------------------------------------------------	------------------------------------------------------------------------------

	CAUTION Situation has the potential to cause damage to property or equipment.
-----------------------------------------------------------------------------------	-----------------------------------------------------------------------------------------

NOTE

Additional information the user or operator should consider.

	Situation has the potential to cause the product to not comply with applicable European Union regulations.
-------------------------------------------------------------------------------------	------------------------------------------------------------------------------------------------------------

	Situation has the potential to cause the product to not comply with applicable United Kingdom regulations.
-------------------------------------------------------------------------------------	------------------------------------------------------------------------------------------------------------

1.2.1 General Warnings

Observe these general warnings when operating or servicing this equipment:

- Heed all warnings on the unit and in the operating instructions.
- Do not use this equipment in or near water.
- Although the input power to this equipment is below 20 VDC, this equipment internally generates much higher voltages that are present on the Model 8742 connector pins. Only properly trained personnel should touch either of these items.
- The Model 8742 is intended to be used as a component in a larger system. When this product is included as part of a larger assembly, the user **MUST** ensure that appropriate additional safety and EMC-compliance features are incorporated the assembly.

- The Model 8742 is typically supplied with an external DC power source. When the external power source is connected to MAINS power, the external power source's detachable power cord may be used to disconnect power to the 8742. Do not position the external power supply so that its MAINS power cord cannot be easily disconnected.
- Disconnect power before cleaning the equipment. Do not use liquid or aerosol cleaners; use only a damp lint-free cloth.
- Lockout all electrical power sources before servicing the equipment.
- There are no user-replaceable fuses in this equipment. The user must ensure that appropriate current-limiting protection is provided by the external DC power source.
- To avoid explosion, do not operate this equipment in an explosive atmosphere.
- Qualified service personnel should perform safety checks after any service.
- Use only the New Focus-supplied MAINS power cord with the external DC supply. Use of under-rated power cords and cause property damage

1.2.2 General Cautions

Observe these cautions when operating this equipment:

- If this equipment is used in a manner not specified in this manual, the protection provided by this equipment may be impaired.
- Do not block ventilation openings.
- Use only the specified replacement parts.
- Follow precautions for static sensitive devices when handling this equipment.
- This product should only be powered as described in the manual.
- There are no user-serviceable parts inside the Model 8742 Picomotor Drive Module.

1.2.3 Summary of Warnings and Cautions

The following general warning and cautions are applicable to this instrument:

	<p>WARNING</p>
<p>The Picomotor Controller/Driver is incomplete in constructional features and is considered only to be a component for the purposes of regulatory compliance. It is "equipment for building in;" a suitable enclosure must be provided so that the unit is not user accessible when incorporated into the final product.</p>	



WARNING

The Model 8742 Picomotor Controller/Driver internally generates non-SELV voltages. These voltages are present, at times, on the Picomotor connectors even when a Picomotor is not connected. The user shall mount the Model 8742 with appropriate barriers, spacings, markings, etc. to ensure that all applicable regulatory requirements are met. **THIS IS THE USER'S RESPONSIBILITY.**



WARNING

Do not attempt to operate this equipment if there is evidence of shipping damage or you suspect the unit is damaged. Damaged equipment may present additional hazards to you. Contact New Focus technical support for advice before attempting to plug in and operate damaged equipment.



WARNING

The Model 8742 is intended for use **ONLY** with New Focus Picomotors. Connection of other devices to the unit's motor connectors may cause damage to the unit or the connected device, fire, and/or personal injury.



WARNING

Before operating the Model 8742 Picomotor Driver, please read and understand all of Section 1.



WARNING

Do not attempt to operate this equipment if there is evidence of shipping damage or you suspect the unit is damaged. Damaged equipment may present additional hazards to you. Contact New Focus technical support for advice before attempting to plug in and operate damaged equipment.



WARNING

Do not apply external DC power to this equipment in excess of 14.5 VDC.



WARNING

Use only the New Focus-supplied **MAINS** power cord with the external DC power supply. Use of an under-rated power cord may cause damage to the product, fire, and/or personal injury.

**CAUTION**

There are no user serviceable parts inside the Model 8742 Picomotor Controller/Driver. Work performed by persons not authorized by New Focus will void the warranty.

**WARNING**

If this equipment is used in a manner not specified in this manual, the protection provided by this equipment may be impaired.

**WARNING**

This instrument is intended for use by qualified personnel who recognize thermal, shock, or laser hazards and are familiar with safety precautions required to avoid possible injury. Read the instruction manual thoroughly before using, to become familiar with the instrument's operations and capabilities.

**CAUTION**

The Model 8742 Picomotor Controller/Driver is designed to be safe when operated under Normal Environmental Conditions as defined in EN61010-1:2010. Operation under harsher environmental conditions can result in severe injury.

**CAUTION**

The case of the Model 8742 Picomotor Controller/Driver is used to dissipate internally-generated heat. Blocking the normal convective airflow around the unit, or thermally insulating the unit, can result in severe injury, damage to the product, and/or fire.

**CAUTION**

When operated at higher pulse rates for extended periods of time, the temperature on the outside of the Model 8742's case may rise above the "surface temperature limits in normal operation" as defined in EN61010-1:2010 unless the user takes appropriate measures. These may include the addition of an external heat sink, barriers to contact, reducing the pulse frequency, or other appropriate mitigations. Failure to take appropriate action when operating the Model 8742 under these conditions can result in severe injury.

	<p>The Model 8742 Picomotor Controller/Driver is intended for use in an industrial laboratory environment. Use of this product in other environments, such as residential, may result in electromagnetic compatibility difficulties due to conducted as well as radiated disturbances.</p>
-----------------------------------------------------------------------------------	--------------------------------------------------------------------------------------------------------------------------------------------------------------------------------------------------------------------------------------------------------------------------------------------

	<p>The Model 8742 Picomotor Controller/Driver is intended for use in an industrial laboratory environment. Use of this product in other environments, such as residential, may result in electromagnetic compatibility difficulties due to conducted as well as radiated disturbances.</p>
-----------------------------------------------------------------------------------	--------------------------------------------------------------------------------------------------------------------------------------------------------------------------------------------------------------------------------------------------------------------------------------------

1.3 Location of Labels and Warnings

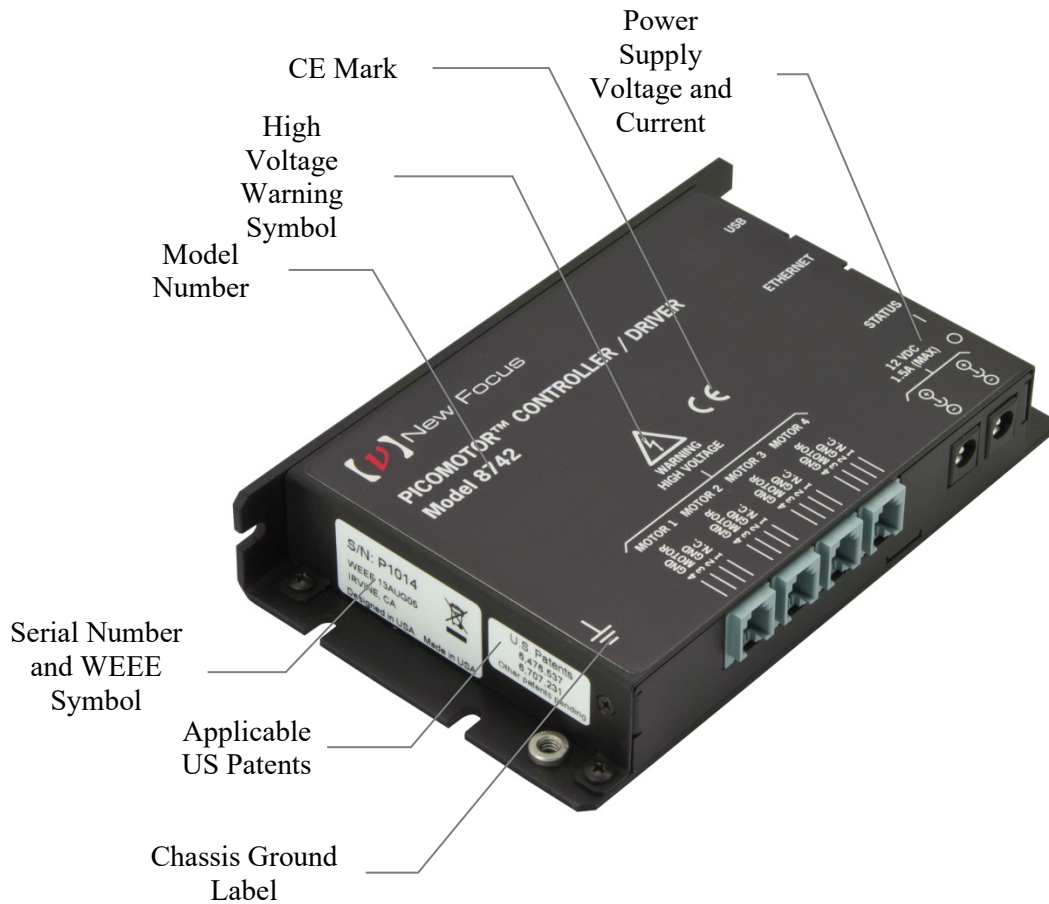

Figure 13 Labels and Warnings

1.4 Safety Grounding Considerations

There are potentially lethal voltages generated within the Model 8742 Picomotor Controller/Driver and presented on the pins of the “Motor” connectors EVEN WHEN NO PICOMOTOR IS INSTALLED. (These voltages are not present when power is not applied to the unit. They are not present when the unit is switched OFF.) The User must manage certain system-level aspects to ensure safe operation. One of these is grounding.

The Model 8742’s external DC power supply provides 12VDC. The negative output from this supply is typically isolated from MAINS earth ground, but this isolation should not be assumed. This same negative output is connected directly to the Model 8742’s external case within the Model 8742. This same “ground” is at the same potential as the MOTOR connectors’ return signal pins. This means that the MOTOR connectors’ drive signal pins are, at times, at VERY HIGH VOLTAGES relative to the Model 8742 case, the USB connector shell, and the DC input/loop-through connectors’ negative terminals.

An 8-32 screw is provided on the unit and marked with the “Ground” symbol shown in Paragraph 1.1.8, above. While it is not necessary to connect this terminal to a building “earth” ground, New Focus recommends doing so because it will simplify system-level compliance with most regulatory requirements. Once this connection is made, the user must ensure that all other system components are appropriately grounded. Do not depend upon the physical mounting hardware to accomplish this grounding.

If the other components are not grounded, a damaged Picomotor (or its wire) could result in a dangerously high voltage being present between anything that is grounded (like the 8742 and a computer attached to it via USB) and the Picomotor case. Note that the simplest way to ground a Picomotor is via its threaded mounting bushing or other mounting hardware. **DO NOT ATTEMPT TO OPEN A PICOMOTOR TO ACHIEVE THIS GROUNDING.**

If system requirements prevent the Picomotor from being grounded, then the user must ensure that the Model 8742 and all other system components (including any USB-connected computers) are properly isolated from earth ground. This is because a short of the high-voltage drive signal to an earth ground may result in potentially lethal voltages existing between the case of the 8742 and anything that is earth grounded, such as a floor. The User is advised to consult all applicable regulations

because this insulation will probably need to have a breakdown voltage of several thousand volts due to lightening concerns.

In summary, New Focus strongly recommends grounding the Model 8742's case.

2 General Information

2.1 System Overview

8742 is a 4-axis open-loop motion controller/driver for Picomotors, offering a complete motion solution for many applications. It can control up to 4 Picomotors and it can work in systems with other Model 8742 and 8743-CL Controller/Drivers to drive a large number of Picomotors. The controller can be programmed via USB, Ethernet, and RS-485 communication interfaces to perform different motion tasks: relative and absolute moves, jogging, etc.

Key Product Features

A number of advanced features make the 8742 an excellent choice for many applications:

- Intelligent 4-axis open-loop control
- Compact, integrated controller and driver design
- Patented Picomotor™ compatibility with auto-sensing technology
- Programmable settings stored in non-volatile memory
- Plug-and-play USB 2.0 interface
- 10/100-Mbps Ethernet connectivity (Sockets interface, TCP/IP, DHCP, UDP)
- Embedded dynamic HTTP server
- RS-485 LAN interface
- Over temperature protection
- Advanced microcontroller technology
- Embedded real-time operating system
- Easy to use Windows software utility
- LabVIEW™ and C# programming support
- Local Power ON / OFF Switch

2.2 Scope of this Manual

Please carefully read this instruction manual before using the 8742 Picomotor Controller/Driver. Be especially careful to observe the warnings and cautions throughout this manual (see Safety Symbols and Terms). If any operating instructions are not clear, contact New Focus.

This instruction manual contains the necessary information for operation and maintenance of the Model 8742, as well as information for troubleshooting and obtaining service if necessary.

2.3 Unpacking and Inspection

The Model 8742 is carefully assembled, tested and inspected before shipment. Upon receiving this instrument, check for any obvious signs of physical damage that might have occurred during shipment. Report any such damage to the shipping agent immediately.

NOTE

Retain the original packing materials in case reshipment becomes necessary.

2.3.1 What is included

The 8742 package contents:

- 8742 Controller/Driver
- USB Flash Drive which contains the user manual, various documents, USB driver, software application and libraries.

2.4 Available accessories

- Hand Control Pad (Model 8758)
- Power supply/AC adapter, 60 Watt (Model 8745-PS)
- Power supply link cable, 6 inch, for daisy chaining multiple controllers together using a single 12 VDC supply (Model 8745-PWR-CBL)
- RS-485 LAN link cable, 6 inch, for daisy-chaining (Model 8745-RS485-CBL)
- USB cable, 3 meter (Model 8745-USB-CBL)
- L-shaped bracket for stacking several Controllers/Drivers (Model 8745-STK-KIT)
- Optical table mounting plate kit (Model 8745-MTG-KIT)

2.5 Safety

Voltages of up to 130 V are accessible inside the 8742 Controller/Driver chassis, mounts, and Picomotors. DO NOT operate the units with the driver or mount covers removed. If the wire of a mount or Picomotor is damaged, discontinue use and return it for repair. If the device is used in a manner not specified by New Focus, the protection provided by the device may be impaired.

Normally, the case of the Model 8742 will rise a few degrees when a Picomotor is moved. Under conditions of extreme use, meaning long distance moves on one or more motor channels, the case temperature may rise above what is considered safe under various international safety conventions. Even after extreme use, the unit's case temperature will drop to safe levels within a few minutes. The user should not touch the case immediately following such use. Note that the Model 8742 does contain internal temperature protection circuitry that will shut down the unit when the case approaches a temperature that could degrade or damage the unit.



CAUTION

The case of the Model 8742 Picomotor Controller/Driver is used to dissipate internally-generated heat. Blocking the normal convective airflow around the unit, or thermally insulating the unit, can result in severe injury, damage to the product, and/or fire.

2.6 Specifications

2.6.1 Operating Limits*

PARAMETER	MIN.	MAX.
Model 8742 Power input voltage (+V IN)	10.5 V	14.5 V
Power Consumption @ 12 Volts	2 Watts (Idle)	11 Watts (@ 2 kHz speed)
Ambient still-air operating temperature	0 °C	65 °C
Storage temperature (non-operating)	-40 °C	95 °C
Relative Humidity, operating (non-condensing)	10%	90%
Altitude		2000 meters
Environment, Use		Indoor Use Only
Pollution Degree		2

*Operating outside the operating limits may damage the unit.

2.6.2 Weight, Dimensions

Weight	9.5 oz (270 g)
Dimensions	(L x W x H) 5.84 in x 3.61 in x 1.02 in 148.3 mm x 91.7 mm x 25.9 mm

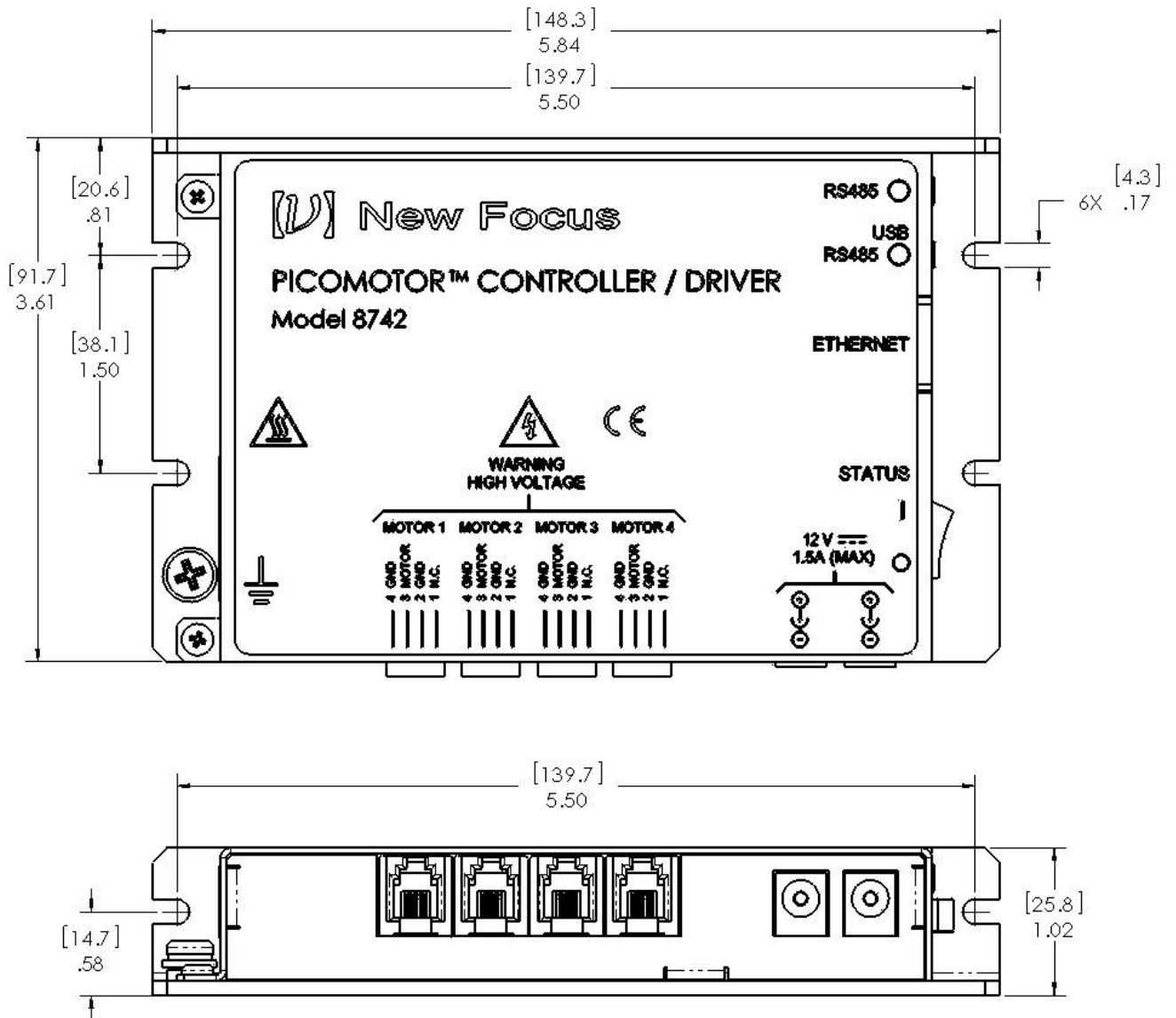

3 Theory of Operation

3.1 How the Picomotor Actuator Works

The patented design of the Picomotor actuator relies on the basic difference between dynamic and static friction. A graphic example of this is the “tablecloth trick”, in which a quick pull of the cloth leaves the dishes on the table, while a slow pull of the tablecloth ends up pulling the dishes off the table (high static friction).

The Picomotor actuator uses the same principle with a threaded jaw, similar to two halves of a split nut, clamped around a precision 80-pitch screw. One jaw is connected to one end of a piezoelectric transducer, and the other jaw is connected to the other end of the transducer. A slow electrical signal applied to the piezo slowly changes the length, causing the two jaws to slide in opposite direction. This slow sliding motion makes the screw turn (static friction). At the end of the transducer motion, a fast electrical signal quickly returns the jaws to their starting positions. Because of the screw’s inertia and low dynamic friction, it remains motionless, holding its position. Simply reversing the order of the fast and slow signals reverses the direction of rotation.

3.2 Stepping the Picomotor with the 8742 Controller/Driver

Although the Picomotor is not a stepper, per se, it can be driven step-by-step. Each step size depends on the Picomotor model, but it is usually $< 30\text{nm}$, allowing for very small, controlled movements.

8742 can be programmed for single step control, as well as a predetermined number of steps. Moreover, 8742 can drive the Picomotor in a continuous motion, in either direction at variable speeds.

As opposed to magnetic motors, the Picomotor actuator has a set-and-forget stability. When no power is applied, the actuator does not move. The user can feel confident that the Picomotor will not change its position, even when the 8742 Controller/Driver is powered off. Therefore, the 8742 has a power ON/OFF switch for convenience. If a user has a 4-Picomotor system, once the system is set, the user can turn the power OFF, to assure that the Picomotors will not be inadvertently moved through computer control. In addition, the 8742 Controller/Driver can be programmed with the outputs disconnected, with the same effect as in the power OFF state.

3.3 Status Indicator

The LED located near the power switch has several functions:

- Power Indicator
- Status Indicator
- Troubleshooter



Figure 14 *Status Indicators position*

When the unit is turned on the unit goes through a series of verifications and turns the LED solid green. The unit is ready to drive Picomotors.

If any problems are found, the LED will blink or turn on a color corresponding to the issue found. Please refer to the following table and call New Focus support if this happens.

CONDITION	LED STATE
No power applied to unit	OFF
Unit OK; no critical errors detected	Solid green
Reboot condition occurred	Fast blinking green for 0.5 second
Unit OK; 8758 hand control pad detected	Slow blinking amber
Corrupted firmware detected	Solid amber
Critical fault detected (e.g. over-temperature)	Solid red

Table 1 *LED Status Indicator*

3.4 Power Supply

The 8742 Controller/Driver can place stress on the system power supply. The stress has two components:

Inrush current: The inrush current on power-up charges the internal filter capacitor. While the energy magnitude of the inrush current is limited, it can still cause problems with power supplies not designed to handle it.

Dynamic load: Dynamic current is supplied to the 8742 internal power supply for each Picomotor drive pulse. The input-filter capacitor will supply more dynamic current as the resistance between the capacitor and system power supply increases. Do not increase this resistance: it will increase ripple-current stress on the internal input-filter capacitor, leading to early failure of the Model 8742. The best strategy is to keep the resistance between the power supply and the 8742 below 0.1Ω and use the power supply recommended by New Focus that came with the 8742 Controller/Driver.

3.4.1 Fault Protection

The 8742 Controller/Driver incorporates circuit-protection schemes to protect itself and the system power supply:

Over-voltage protection: If the power input voltage exceeds 16.7 to 18.5 V, a transient voltage suppressor (TVS) shunts the power input to ground. The internal 2.5 A fuse will then open. The TVS will also shunt the power input to ground if an internal fault shorts any high voltage to the power input. The input fuse will also open if the input power voltage is reversed. Brief power supply transients will not blow the fuse. Therefore, it is highly recommended to use the correct New Focus-supplied power supply. If the fuse was blown, the unit has to be serviced by New Focus. It is not user replaceable.

Over-temperature protection: If the base plate of the unit reaches 80°C , the unit will turn the status indicator solid red to tell the user that the base plate, which acts as a heatsink, reached the maximum allowed temperature. The user is expected to take some measures like decreasing the pulse rate, force-air cool the 8742 case, or use an extra heatsink. If the case temperature continues to rise, at 85°C the output will be turned off. The output will remain off until the base plate temperature decreases to 75°C , when the output will be ready to drive the motor again. In that case the status indicator will turn solid green to indicate that the normal operation has resumed (see Table 1). If left unattended, the unit will protect itself cycling between 85°C and 75°C .

The unit does not need an extra heatsink in normal laboratory environment. However, if forced cooling is needed, usually at high ambient temperatures, a heatsink can be mounted using the 4 slots of the unit base (see Figure 14).



Figure 15 *Heatsink mounting slots*

3.5 Input / Output Connections

Figure 14 shows the 8742 input and output connections.

Communication Interfaces: USB, Ethernet, RS-485 (2)

Power Inputs: +12VDC (2)

Picomotor Interfaces: 4

The following figure shows the position of the inputs and outputs as well as the power switch.

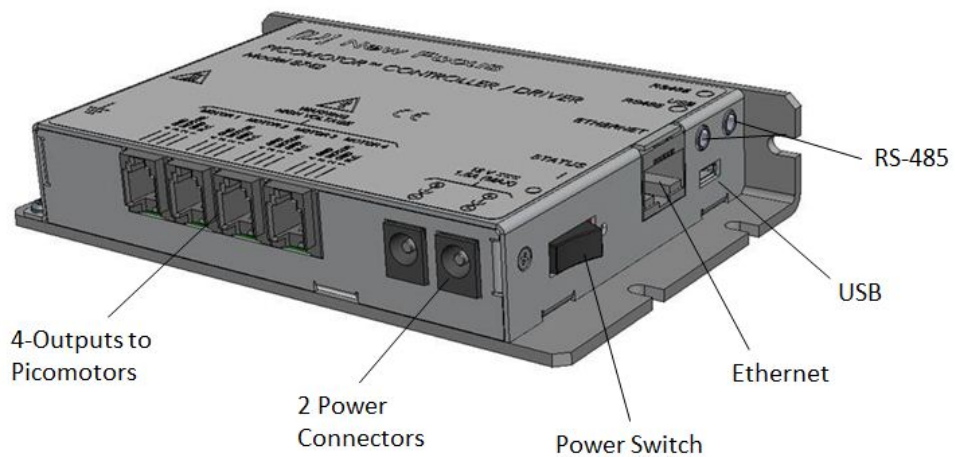

Figure 16 *8742 Inputs and Outputs*

3.5.1 USB

The USB input is a Micro-AB connector. Use a Micro-B to USB-A cable to connect the 8742 Controller/Driver to a computer.

3.5.2 Ethernet

The Ethernet input is a standard RJ-45 connector. Use a Cat 5 Ethernet cable to connect the 8742 Controller/Driver to a router, an Ethernet switch, or a computer.

3.5.3 RS-485

There are two RS-485 connectors that accept standard 3.5mm stereo plugs. The two connectors are connected in parallel inside the Model 8742. (The wiring convention is TIP = D+, RING = D-, SLEEVE = GND.) These connections are used to simplify the wiring between an external computer and multiple 8742 or 8743-CL Controller/Driver units.

See Section 4.7.3 Using RS-485 LAN to Daisy-Chain and Section 5.5 RS-485 Communication for more information on setting up these configurations. See the Accessories Section 2.4 for information on an RS-485 cable that will facilitate normal multi-unit linking.

3.5.4 Power

There are two power inputs that can take a standard barrel connector with the output diameter 5.5 mm and internal diameter 2.1 mm. The provided power supply can be plugged in either of these two connectors. The other connector is used to link the power supply to another 8742 Controller/Driver. See the Accessories Section 2.4 for information on the Power supply link cable.

Use the power switch to turn the unit ON and check the LED status as described in Section 3.3.

3.5.5 Picomotor Interfaces

Each 8742 can drive up to 4 Picomotors, one motor at a time. Before connecting, inspect the Picomotor cables, connectors and generally their integrity. The Picomotors will receive high voltage pulses that can be dangerous if wires are exposed. Contact New Focus if you see any problems.

Do not connect anything else to the 8742 outputs. The Controller/Driver is designed to handle only New Focus standard Picomotors. If the output is shorted or otherwise misused, an internal component will open and the unit will have to be serviced.

3.6 Mounting the unit

8742 may be set on a table top.

While not required, the 8742 can be bolted to the table top in either horizontal or vertical orientation.

Under conditions of extreme usage, the case temperature of the Model 8742 may exceed the levels considered safe by various international safety conventions. If such use is anticipated, the user must position, or block access to, the unit so that the unit cannot be accidentally touched.

4 Initial Setup

4.1 Introduction

This section contains information on how to connect the 8742 Controller/Driver to your local line voltage and how to connect the Picomotor to the controller. It also includes a discussion about the remote interface and the instrument's power-up.

4.2 Grounding

Connect the 8-32 grounding screw to a good earth ground using a dedicated wire of at least 20AWG diameter. See Section 1.4 for advice on making this connection

4.3 Power

Make sure that that power switch is in the off position. Connect the external power supply to AC and connect the power barrel plug into one of the 8742 power inputs. If more than one unit needs to be connected to the same power supply use the power link cable to daisy-chain them. Up to 3 units can be powered by one power supply.

4.4 Connecting 8742 to a Computer via USB

The 8742 Controller/Driver can be connected to a computer with a standard Micro-B to USB-A cable. If several 8742 units have to be connected to the same computer the user can connect them to a USB hub and then connect the hub to the computer USB input. Alternatively, the first unit can be connected to the computer with subsequent units daisy-chained as described in Section 4.7.3 Using RS-485 LAN to Daisy-Chain.

4.5 Connecting 8742 to a Computer via Ethernet

4.5.1 Connecting to a Router

The 8742 Controller/Driver can be connected to an Ethernet Router. Attach the computer Ethernet cable to the same router. If desired, the router can be attached to a WAN (Wide Area Network) so that the computer can also be connected to internet, or company network.

By default, the 8742 Controller/Driver is set for DHCP (Dynamic Host Configuration Protocol). This means that, when connected to a router which is set in DHCP mode, the router will automatically assign it a local IP address from the router address pool. The computer will also receive a local IP address. The IP address normally will be in the range of 192.168.1.1 to 192.168.255.255. Check your router settings to verify the IP address pool.

As soon as both units, 8742 and computer, are connected to the router the Picomotor Controller/Driver is ready to communicate with the computer. The discovery utility will automatically find the IP address of the 8742 Controller/Driver and the user can start sending commands to the unit. See Section 5 for details.

If several 8742 units have to be connected to the same computer the user can connect them individually to an Ethernet hub or router. Alternatively, the first unit can be connected to the router (or computer) with subsequent units daisy-chained as described in Section 4.7.3 Using RS-485 LAN to Daisy-Chain.

4.6 Picomotor Connections

Each Model 8742 controller/driver can control one of four 4-pin RJ-22 single output ports for use with any single-channel Picomotor actuator at any given time.

RJ-22 motor connector pinouts are as follows:

Pin-1	Not Connected
Pin-2	Ground
Pin-3	Motor
Pin-4	Ground

The model 8725 multi-axis adapter can be used to connect the 4-pin RJ-22 output ports to New Focus™ Picomotor products with 6-pin RJ-11 connectors.

4.7 Connecting Multiple Units to a Computer

The L-bracket (Figure 16) is an optional accessory to stack up several 8742 or 8743-CL units. The stack is shown in Figure 17.

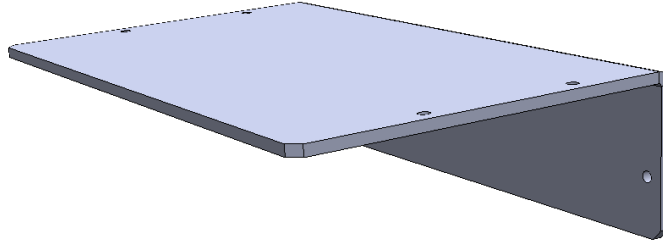

Figure 17 *L-bracket*

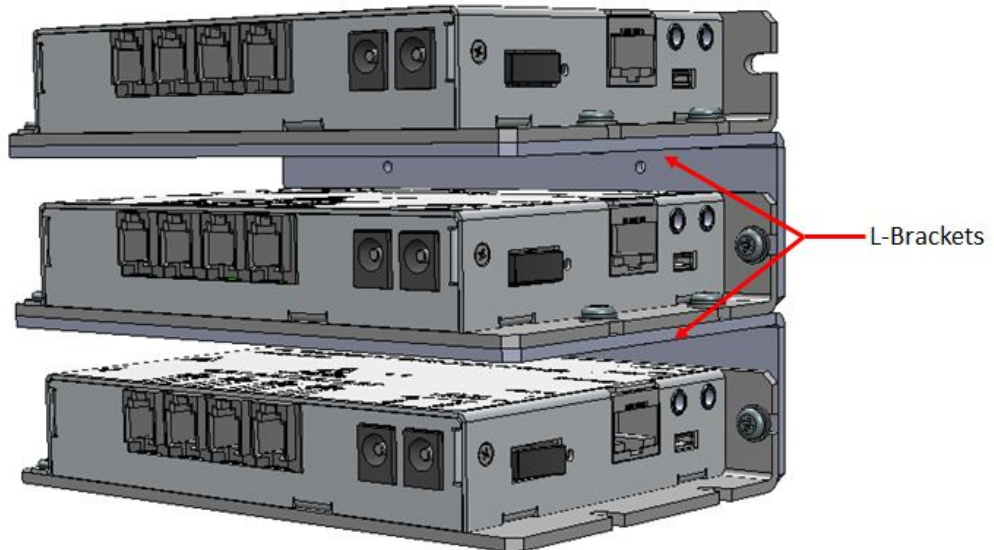

Figure 18 *Using L-brackets to stack up several Controllers*

4.7.1 Using USB Hubs

Each 8742 Controller/Driver in the stack can be connected to a USB hub. Connect the hub to a computer and launch the Picomotor Application provided on the USB Flash Drive. The application will automatically discover and display the 8742 units and make them available for control.

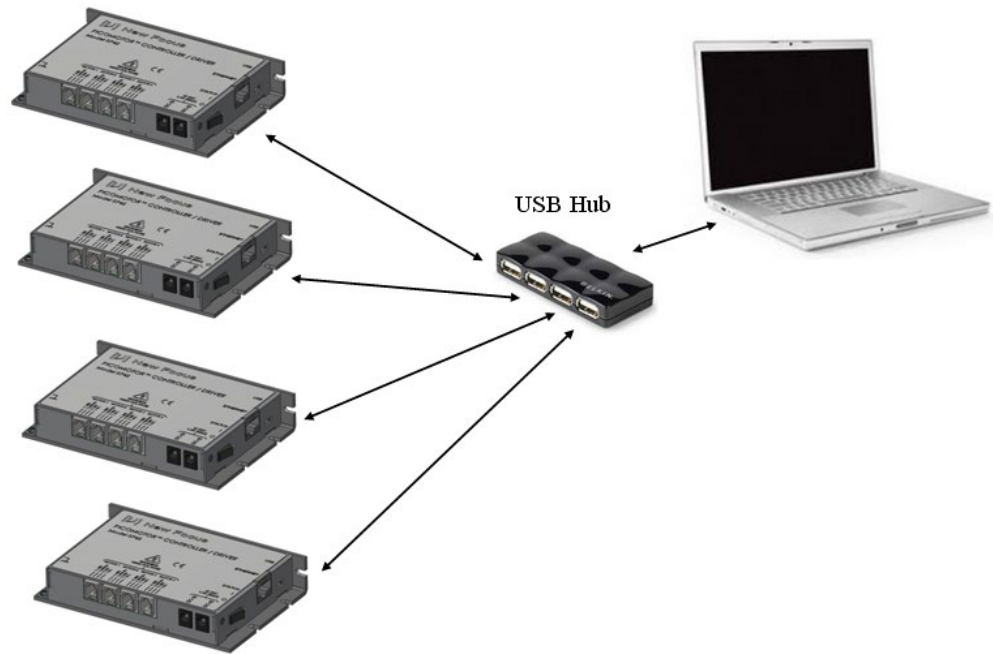

Figure 19 Connecting four units to a computer via a USB hub

4.7.2 Using Ethernet Routers/Switchers

If several 8742 units need to be controlled via Ethernet, connect them to a router at the LAN (Local Area Network) ports. The router will assign an IP address to each 8742 Controller/Driver. Connect a computer to the same router at one LAN port. Use the Picomotor Application provided on the USB Flash Drive to discover and establish a connection to each 8742 unit.

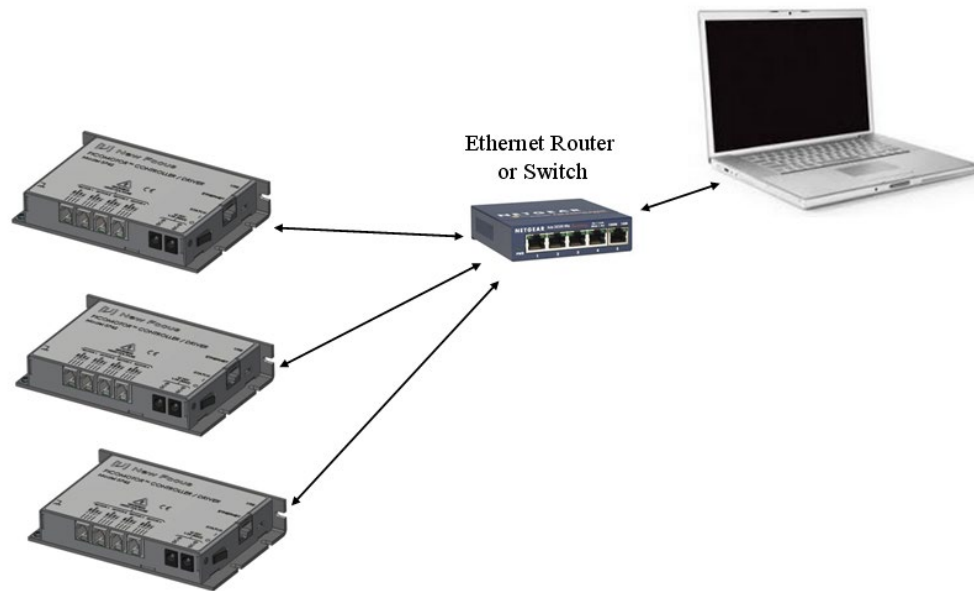

Figure 20 *Connecting three units to a computer via an Ethernet router*

4.7.3 Using RS-485 LAN to Daisy-Chain

If several 8742 units need to be controlled via Ethernet or USB, they do not all have to be connected directly to an Ethernet Switch or USB Hub. Instead, a single unit can act as a gateway by connecting it to the Router, Switch, or Hub and also connecting it to the remaining units using a half-duplex RS-485 LAN bus. In these configurations, the “Gateway” unit, henceforth referred to as the Master Controller, will be a bus master while the other units will be slaves.

To facilitate these connections, each 8742 has two 3.5mm phone jacks connected in parallel. The wiring convention is TIP is D+, RING is D-, and SLEEVE is ground.

The normal convention with RS-485 is a daisy-chain configuration of devices; a “STAR” configuration is not supported. A nominally 100-ohm resistance is applied between the D+ and D- wires at each end of the bus, but not at the units in the middle of the bus. To simplify implementation of these bus termination resistances, the 8742 applies a 100-ohm termination between the D+ and D- wires UNLESS a plug is inserted into BOTH of the 3.5mm jacks. In other words, the two 3.5mm jacks in the 8742 each have integrated switches that go open-circuit when a plug is inserted into the connector. The switches in the two jacks are connected in parallel, as are the TIP, RING, and SLEEVE connections. Thus, the termination will be applied between the D+ and D- wires at each end of the daisy-chain. Units in the middle of the daisy-chain will not apply their termination resistances because both of their jacks will be occupied.

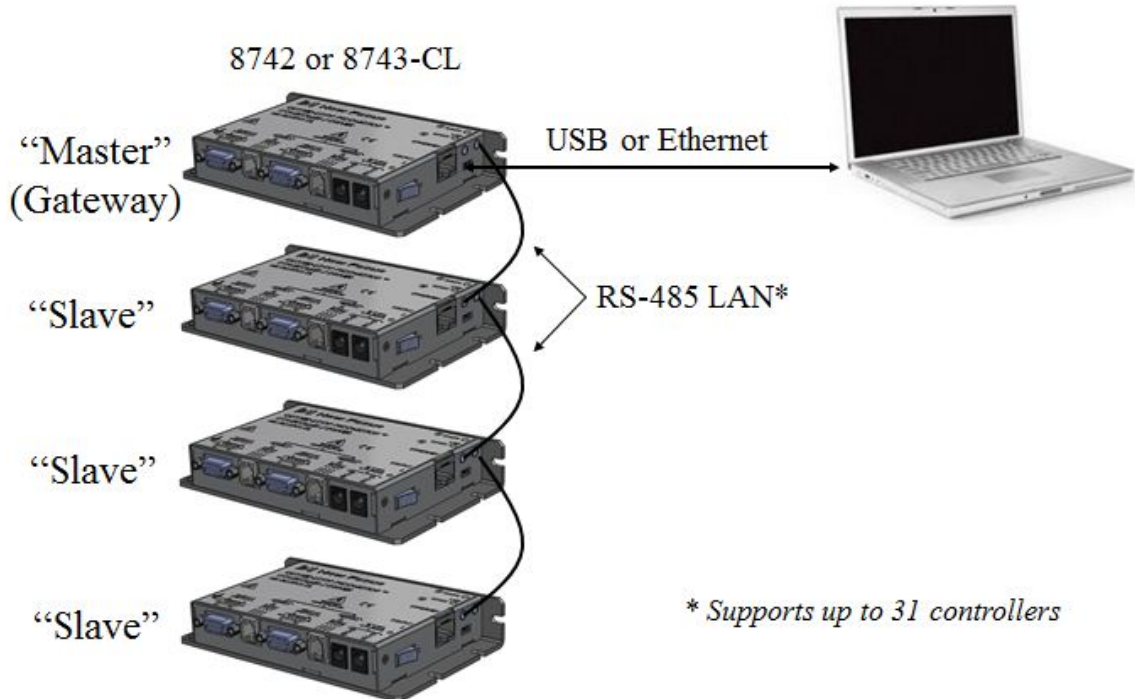

Figure 21 Connecting four units to a computer via RS-485 LAN

This product's RS-485 LAN implementation is a multidrop, half-duplex, 2-wire, differential signaling, balanced line over twisted pair setup. Hence, 1.2 km (~4K feet) distance is theoretically possible.

Note that it is possible to use an off-the-shelf third party RS-485 converter/adaptor to connect into the controller's RS-485 LAN as an alternative to USB or Ethernet connectivity. However, the Picomotor Windows application and software support will not detect the controller's presence in this configuration and, therefore, user developed software will be required to make it communicate with the PC.

Applications handling the RS-485 bus terminations externally can cause a unit at the end of the daisy-chain to disconnect its internal termination by inserting an unconnected 3.5mm plug into the otherwise unused jack.

For more details on RS-485 LAN communication please see Section 5.5.

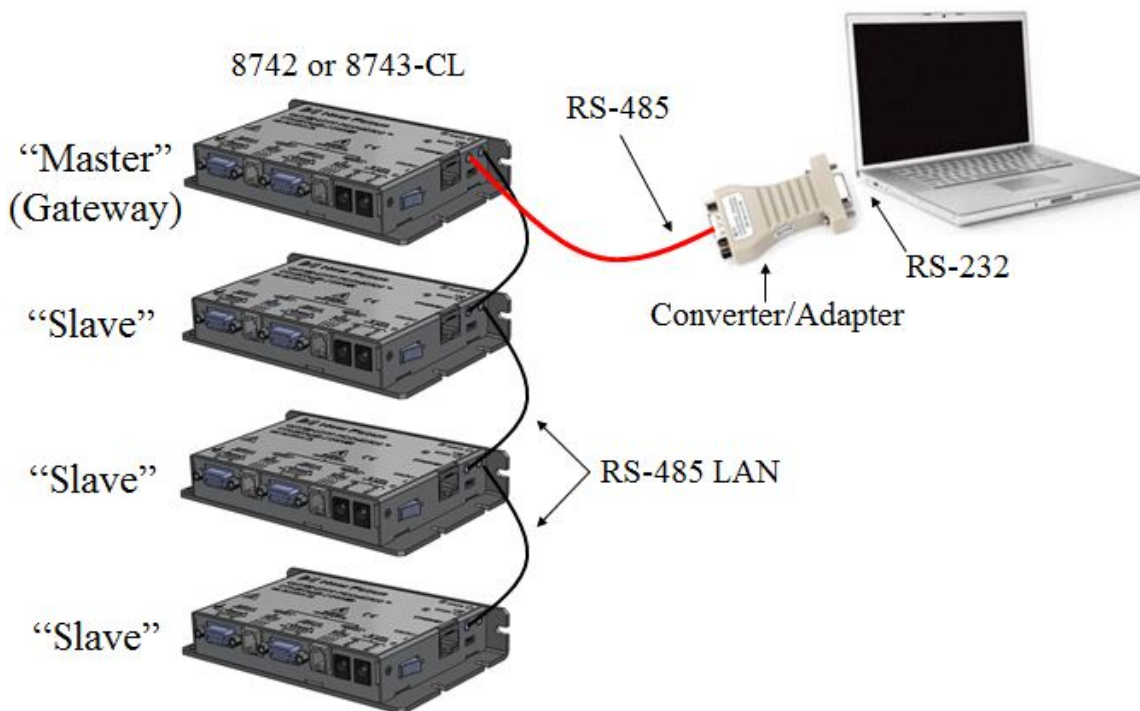

Figure 22 *Connecting four units to a computer via RS-485 adapter*

4.8 Connecting to the 8758 Hand Control Pad

The model 8758 hand control pad facilitates local (non-computer) control of positioners connected to 8742 Picomotor controllers. It draws its electrical power from the Picomotor controller via USB interface and, hence, does not require a separate power supply.

IMPORTANT: 8742 controller must run firmware version 2.2 (or later) to be compatible with the 8758 hand control pad.

NOTE: Read the 8758 User's Manual completely before connecting it to the 8742 controller.

The 8758 hand control pad connects directly to the 8742 controller's USB port. Therefore, only the controller's Ethernet and RS-485 port will be available for computer interfacing, if needed.

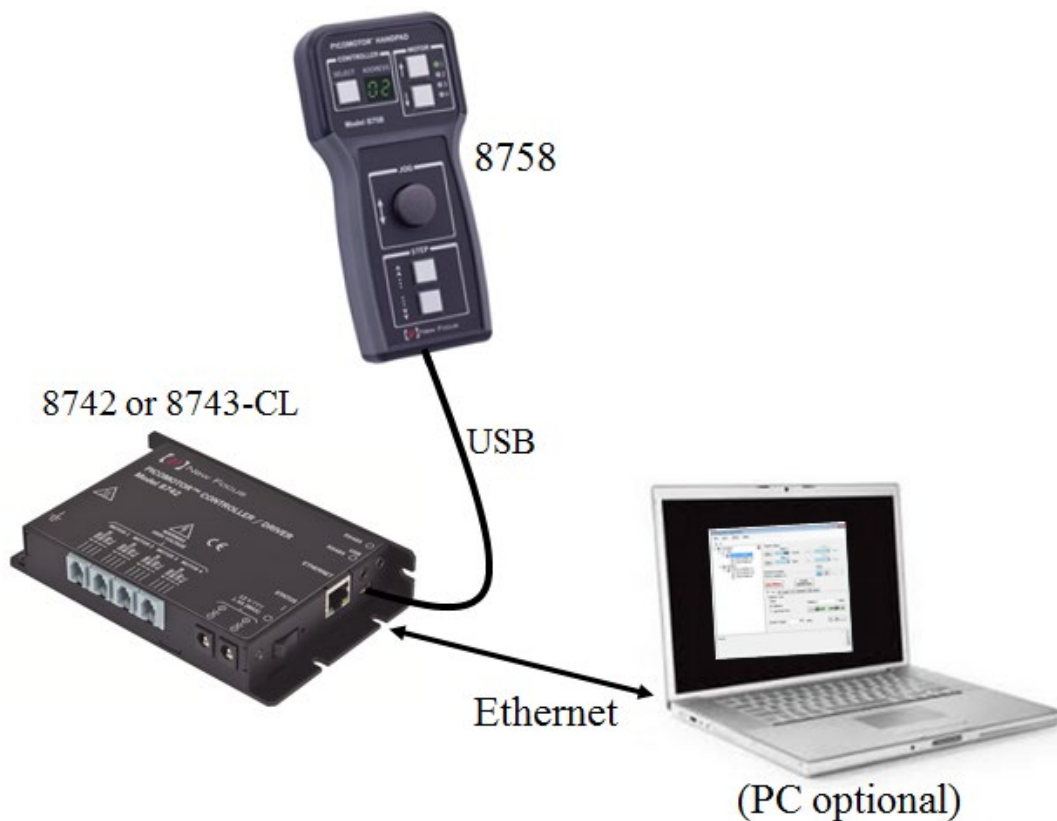

Figure 23 *Single Controller Setup*

The 8758 hand control pad is capable of interfacing with up to 31 Picomotor controllers when configured in the RS-485 daisy-chained “Master/Slave” setup shown below.

The controller that has the 8758 connected to it automatically becomes the designated Master Controller. A Master Controller initiates and arbitrates RS-485 communication to all Slave controllers on behalf of the 8758 hand control pad or PC.

To avoid RS-485 LAN message conflicts only one(1) network Master is allowed. Therefore, only the 8758 designated LAN Master Controller is permitted to connect to a PC via its available Ethernet port, if computer communication is also desired.

NOTE: Picomotor controllers will only execute move commands from one source (8758 or PC) at any given time.

NOTE: Do not connect the PC to any Slave controller’s USB, Ethernet, or RS-485 port. Only connect the PC to the Master controller.

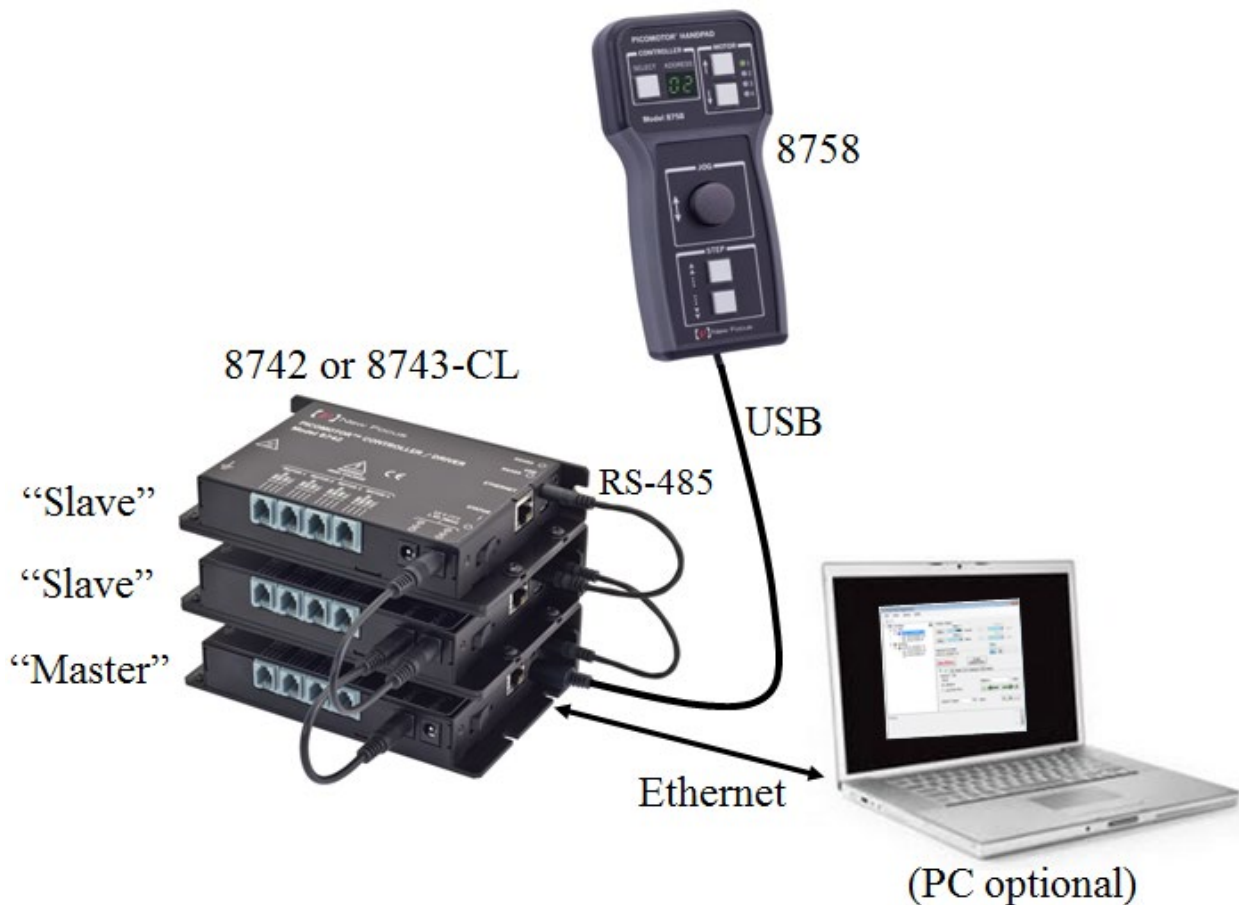

Figure 24 Multiple Controller Setup

5 Computer Interfacing

5.1 Introduction

The Model 8742 Controller/Driver has two computer interface ports: USB-Device and Ethernet. All commands for the 8742 Controller/Driver are device dependent commands.

Please see the General Guidelines sections for using either the USB (Section 5.3), or Ethernet (Section **Error! Reference source not found.**) interfaces. These sections include important information on using these interfaces properly.

5.2 Computer Interface Terminology

Key abbreviations and concepts used in the command reference section of this manual are listed below:

<CR> Carriage Return

The ASCII decimal “13” byte.

<LF> Line Feed

An ASCII decimal “10” byte.

<NL> New Line

Whitespace

Optional between commands and between parameters. Whitespace is any character with a binary value less than or equal to an ASCII space character (except the <NL> character).

Numerical types

Numerical parameters are passed and returned as the actual ASCII characters in the string representation of the number. The 8742 Controller/Driver Series instrument accepts numeric values in decimal format only.

5.3 USB Communication

Before connecting the controller to a host PC using a standard Micro-B to USB-A cable, the user should install the application included in the USB Flash Drive that accompanies the Unit. The application automatically installs the correct USB drivers. Communication can be done through this interface by using the application or by developing software in the user’s preferred programming language.

The USB Flash Drive contains communication drivers and software for operating the controller/driver.

5.3.1 USB Command Termination

Commands and queries sent to the 8742 Controller/Driver through the USB port must be terminated by a <LF> (line feed).

All responses sent by the 8742 Controller/Driver are terminated with a <LF> (line feed).

5.4 Ethernet Communication

The default Ethernet configuration should work for most users. Simply connect the 8742 controller to your Ethernet router, install and run the Picomotor application software that came with the product. After a few seconds, mostly depending on network TCP/IP negotiation with router and/or computer, the software should automatically ‘discover’ the controller on the network and Picomotor control may begin. Be aware the computer will not be able to discover the controller if the network does not have a DHCP server (included in most routers) because the 8742 does not support auto-negotiation of IP addresses. If the network lacks a DHCP server, the 8742 must be configured for static IP addressing.

This controller supports the following network protocols: IP, TCP, UDP, ICMP, DHCP, PPP, ARP. Additionally, Sockets interfacing is supported.

The 8742 provides various commands to help setup and tailor Ethernet communication to most needs. (See below)

COMMAND	DESCRIPTION
GATEWAY	Default gateway address
GATEWAY?	Default gateway address query
HOSTNAME	Hostname
HOSTNAME?	Hostname query
IPADDR	IP address
IPADDR?	IP address query
IPMODE	IP mode
IPMODE?	IP mode query
MACADDR?	MAC address query
NETMASK	Network mask address
NETMASK?	Network mask address query

Table 2 Ethernet Related Commands

5.4.1 Ethernet Dynamic and Static IP Address Setup

Use the Picomotor Controller Software Application to access the Ethernet setup window, as shown in Figure 31.

Alternatively, you can use the IPMODE command to setup either Dynamic or Static IP mode

The IP mode command (IPMODE) is used to set the controller's IP mode. In order for this setting to take effect, please save this setting in the controller's non-volatile memory and reset the controller.

As the name implies, Static IP addresses are the same every time you connect. Dynamic IP addresses may change each time you connect to the Ethernet Local Area Network. Dynamic IP addresses are the normal customer access method used by most ISPs or Service Providers and this is the default IP mode for this product.

When your 8742 controller is configured for Dynamic IP addressing, upon power up or connection to the LAN it will automatically send a message to every device on the network and ask if the other device(s) are DHCP servers. (There should be exactly one DHCP server on the network.) The non-DCHP server devices will ignore the message; the only DCHP server on the network will respond to the 8742 with a "use IP address xx.xx.xx.xx" message. The 8742 will then begin using this IP address.

When your 8742 controller is configured for Static IP addressing, upon power up it will retrieve its previously-stored IP address from non-volatile memory within the 8742 and begin using this IP address.

NOTE: Send Ethernet commands via USB interface as Ethernet communication may become unstable during Ethernet settings configuration. While connected via USB, use the Picomotor application software to send commands (Go to 'Terminal' tab).

5.4.2 Using a Static IP Address

For those who can make changes to the router through its configuration software

The preferred method is to use the Picomotor Controller Software Application to access the Ethernet setup window, as shown in Figure 31, to setup the static IP Address, Gateway and Subnet mask.

Alternatively, you can send commands to the controller to set up your system for use with a static IP address as follows:

1. In the router configuration software, reserve an IP address for the picomotor controller. Try to reserve an IP address outside of the range used by the DHCP server because this will eliminate the possibility of address conflicts now and in the future.
2. Set the picomotor controller to use a static IP addressing by sending the "IPMODE 0" command.
3. Set the 8742 controller's static IP address to the reserved value by sending "IPADDR xx.xx.xx.xx: where xx.xx.xx.xx is the reserved value.
4. Send "GATEWAY xx.xx.0.0" (where the first two octets match those of the IPv4 Address).
5. Send "NETMASK 255.255.255.0.
6. Send the "SM" command to the controller to save the information entered.
7. Send the "RS" command to reset the controller so that all entered information will take effect.

For those who cannot make changes to the router or for a peer to peer connection

Note: When the Peer-to-Peer Ethernet connection is used, the 8742 controller must be set for Static IP. DHCP Auto-negotiation of IP addresses (without a DHCP server in the network) is not supported.

1. Open a DOS command window and run "IPCONFIG".

```
Ethernet adapter Local Area Connection:
    Connection-specific DNS Suffix . :
    Link-local IPv6 Address . . . . . :
    IPv4 Address. . . . . : 192.168.1.123
    Subnet Mask . . . . . : 255.255.255.0
    Default Gateway . . . . . : 192.168.1.1
```

2. Note the first two octets of the IPv4 Address of the PC (192.168 in the example above).
3. Set the picomotor controller to use a static IP address by sending the "IPMODE 0" command.

4. Send “GATEWAY 192.168.0.0” (where the first two octets match those of the IPv4 Address or the host address from the log file (“CreateUDPSockets: Host Address = 192.168.1.123”).
5. Send “NETMASK 255.255.0.0”.
6. Set the static IP address by sending “IPADDR 192.168.1.150” (where the first two octets match those of the IPv4 Address or the host address from the log file (“CreateUDPSockets: Host Address = 192.168.1.123”). If the host address is being automatically generated by a DHCP server then try to select a static IP address outside of the range used by the DHCP server because this will eliminate the possibility of address conflicts now and in the future.
7. Send the “SM” command to the picomotor controller to save the information entered.
8. Send the “RS” command to reset the controller so that all entered information will take effect.

For more information, see the following links:

http://en.wikipedia.org/wiki/Default_gateway

http://en.wikipedia.org/wiki/IPv4_subnetting_reference

5.4.3 Ethernet Peer-to-Peer Cabling

Peer-to-Peer Ethernet connection means connecting your 8742 directly to your PC without the use of a router. This may or may not require the use of a special Ethernet 'crossover' cable as many new computers no longer require it.

An Ethernet crossover cable is a type of Ethernet cable used to connect computing devices together directly. Normal straight through or patch cables were used to connect from a host network interface controller (a computer or similar device) to a network switch, hub or router. A cable with connections that "crossover" was used to connect two devices of the same type: two hosts or two switches to each other. Owing to the inclusion of Auto-MDIX capability, modern implementations of the Ethernet over twisted pair standards usually no longer require the use of crossover cables. Refer to Section 5.4.2 for how to setup a peer-to-peer connection.

5.4.4 Communicating Using a Hostname

The hostname (HOSTNAME) command is used to set the controller's hostname. A hostname is a label or nickname assigned to a device connected to a computer network and is used to identify the device in various forms of communication. This feature enables users to assign the controller a more easily identifiable name, perhaps linked to its actual function in an application (e.g., TIPTILT, MIRROR-2). This command is more common with Ethernet but can also be used with USB communication.

NOTE: Send Ethernet commands via USB interface as Ethernet communication may become unstable during Ethernet settings configuration. While connected via USB, use the Picomotor application software to send commands (Go to 'Terminal' tab).

The default hostname for the controller is 8742-serialnum, where serialnum is the controller's serial number. The hostname can have a maximum of 15 alphanumeric characters. The first character in the hostname cannot be a hyphen ("-"). Issue Save (SM) and Reset (RS) commands to controller to take effect.

5.5 RS-485 Communication

RS-485 interface can be used to communicate with up to 31 Picomotor controllers (8742 or 8743-CL) that are daisy-chained, using a single USB/Ethernet connection.

Once the desired controllers are daisy-chained using the RS-485 link cable, any one of these controllers can be connected to a host PC via USB or Ethernet interface. The controller on the network that is directly connected to a host PC is referred to as the “master controller”. This controller is responsible for receiving commands from the host PC, and sending responses, if any, back to the host PC.

NOTE: There can be only one master controller on the RS-485 local area network (LAN).

All the controllers connected to a master controller via RS-485 link cable are referred to as the “slave controllers”. There can be up to 30 slave controllers connected to 1 designated master controller.

When the master controller receives a command from a host PC, it first determines if the command is addressed to it or if the command is addressed to one of the slave controllers. If the command is addressed to it, it processes the command and sends any responses back to the host PC. On the other hand, if the command is addressed to one of the slave controllers, it transmits the command on the RS-485 LAN. Since the controller RS-485 is configured in a multidrop, parallel bus topology, all the slave controllers receive the command transmitted by the master controller. Each slave controller then determines if the command is addressed to it, and processes the same if it is the intended recipient. All other slave controllers ignore the received command. If the command is a query (i.e., requires response), the slave controller that processed the command may transmit the response on the RS-485 LAN. Once again, all the controllers on the RS-485 LAN, including the master controller, receive the response transmitted by the slave controller. The master controller determines that the information it received on the network was a response to a command it had initially transmitted on the network, and sends this response to host PC; all the slave controllers ignore the response they received.

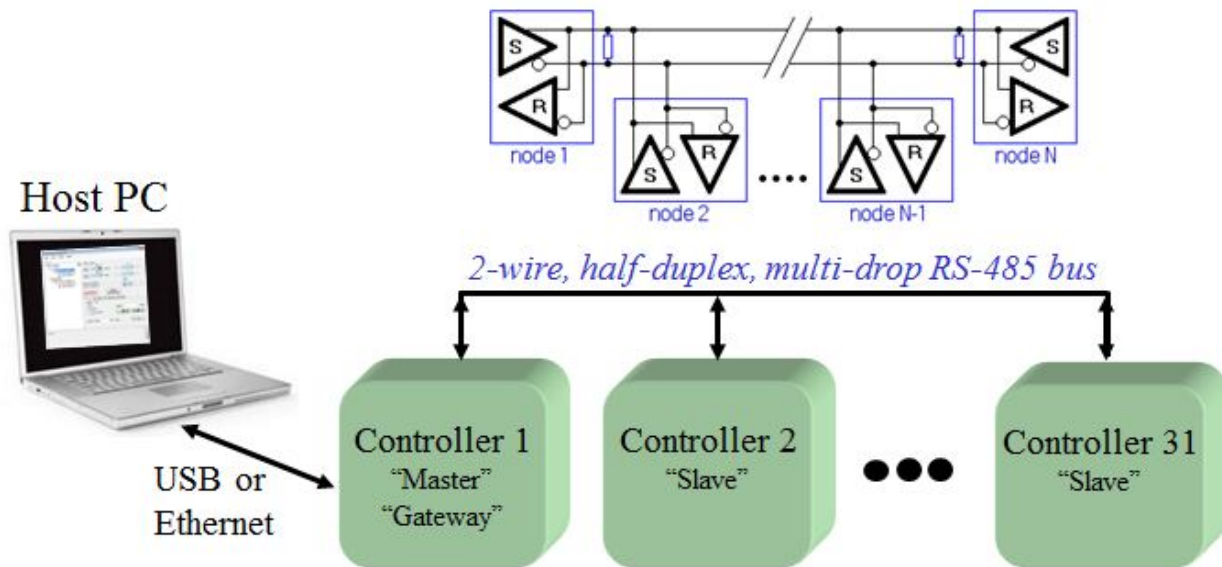

Figure 25 Picomotor Controller RS-485 LAN Topology

Note that a **multidrop bus** is a computer bus in which all components are connected to the same set of electrical wires. A process of arbitration determines which device gets the right to be the sender of information at any point in time. The other devices must listen for the data that is intended to be received by them. Multidrop buses have the advantage of simplicity and extensibility.

5.5.1 Setting up an RS-485 Network

All the controllers on an RS-485 network must have unique addresses in order for a host PC to communicate with them individually. In the case of Picomotor Controllers, these addresses can be values (integers) between 1 and 31. Since the default address of a controller is 1, users must change the addresses of the controllers to unique values.

There are two (2) ways—manual and automatic—in which unique addresses can be assigned to all the controllers. The manual approach involves powering ON only one controller at a time, connecting this controller directly to a host PC via USB/Ethernet, changing the address to a desired value using “SA” command, saving the address in the controller using “SM” command, and powering OFF the controller. This process must be repeated for all the controllers on the network.

Picomotor Controllers support a novel automatic approach that allows a master controller to assign unique addresses to all the slave controllers. The automatic approach involves powering ON all the controllers on the network, issuing “SC” command to initiate scan process, and waiting for the scan process to complete by

monitoring the scan status via “SD?” command. Once the scan is completed, the master controller can be queried to find out the addresses of all the slave controllers.

NOTE: The Picomotor Windows software application (version 2.0 and above) provides the quickest and easiest path to controller address configuration. The user friendly software will automatically report any RS-485 address conflicts found and offer easy resolution options.

The Remote Command Set chapter provides a detailed description of the commands used to setup the RS-485 network.

The 8742 provides various commands to help setup the RS-485 network. (See below)

COMMAND	DESCRIPTION
SA	Set controller address
SA?	Controller address query
SC	Initiate scan process
SC?	Scan result query
SD?	Scan status query

Table 3 RS-485 LAN Related Commands

5.5.2 Communication with a Slave Controller

All the commands intended for a slave controller connected via RS-485 LAN must have a slave controller address prefix added to the command. For example, to query the motion status of motor 2 on a slave controller with address 3, the host PC must send “3>2MD?” command to the master controller via Ethernet or USB. In this command, “3>” is the slave controller address prefix. This prefix tells the master controller that the command “2MD?” is intended for slave controller with address 3 on the RS-485 LAN.

When the master controller sends a response back to host PC, it too will have a slave controller address prefix. This is used to inform the host that the response came from a slave controller with that address. For example, the response received by a host PC to the above mentioned command might be “3>1”. This indicates that the motion of motor #2 in slave controller with address 3 is complete.

NOTE: RS-485 LAN transmission speed is 115 Kbit/s (~100 µs/character)

If a command does not have controller address prefix, the master controller will assume that the command is addressed it and process the same.

NOTE: The host PC is effectively the ‘master’ in the special case of direct LAN connection via RS485-to-RS232 adapter/converter configuration

5.6 Picomotor Controller Software Application

5.6.1 Introduction

Included with the Picomotor controller is a Windows software application to facilitate quick, user-friendly motion system check via controller's USB or Ethernet interfaces. This application comes on a USB flash drive or can be downloaded from the product's Newport.com web page 'Downloads' section.

NOTE: If you already have installed a different version of the software and drivers then it is recommended that you uninstall it first before installing new software.

Before connecting the instrument to a host PC using a standard Micro-B to USB-A cable, the user should install the application included in the USB Flash Drive that accompanies the Unit. The application automatically installs the correct USB drivers. Communication can be done through this interface by using the application or by developing software in the user's preferred programming language. The USB Flash Drive contains the communication drivers and software for operating the controller/driver.

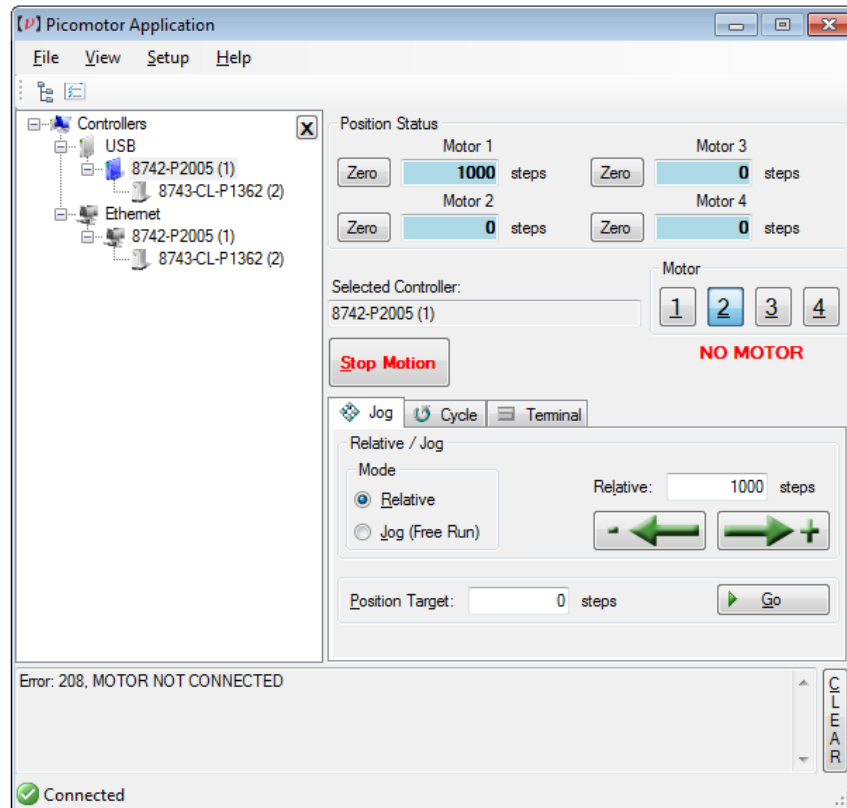

Figure 26 Picomotor Application Software

5.6.2 Overview

This Windows software application has advanced auto-discovery feature which automatically finds computer connected Picomotor controllers and list them in the “Device Tree” window. So called ‘Slave’ controllers (devices) connected via RS-485 LAN are listed immediately underneath and shifted to the right of ‘Master’ controllers which have direct computer connection. The user can then select the controller to operate. Also, near the upper right area of the application the user can select which specific motor (1, 2, 3 or 4) to control.

NOTE: In the device tree window, the software will show the address (1-31) to the right of each controller’s model number/serial number information in parenthesis only when controllers are connected together via RS-485 LAN.

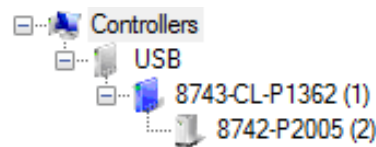

Figure 27 Controller Address Identification

At the bottom of the application is a “Message” window where application and controller generated messages are shown (e.g., error messages, status).

Additionally, at the very bottom of the application is a connection status indicator which lets the user know when the application is actively communicating with a controller.

There are three(3) main application views or tabs: (1) Jog tab, (2) Cycle tab, and (3) Terminal tab.

The Jog tab allows a user to “jog” a motor forward or backward in predefined “relative” displacements or in “free run” (continuous) moves, depending on mode selected. In this tab view one can also move to an “absolute” target position.

In the Cycle tab, a user can enter two “absolute” position destinations to have the Picomotor cycle between these two points with programmable dwell time between stops and optional number of cycles limit.

The Terminal tab allows users familiar with the controller’s ASCII commands to manually type and send commands to the controller, thereby offering maximum flexibility and control.

Additionally, there are File, View, Setup, and Help menus selections at top of application screen.

Most notably the Setup/Controller menu selection allows the user to set motor velocity, acceleration, and motor type for each axis. The parameters shown on the

pop-up window represent the settings read from the controller's memory. Clicking 'Apply' button will immediately send the updated parameters to the controller and save them in its non-volatile memory. The 'OK' buttons does the same action as 'Apply' plus it then closes the Setup window.

Jog Motion and General Overview

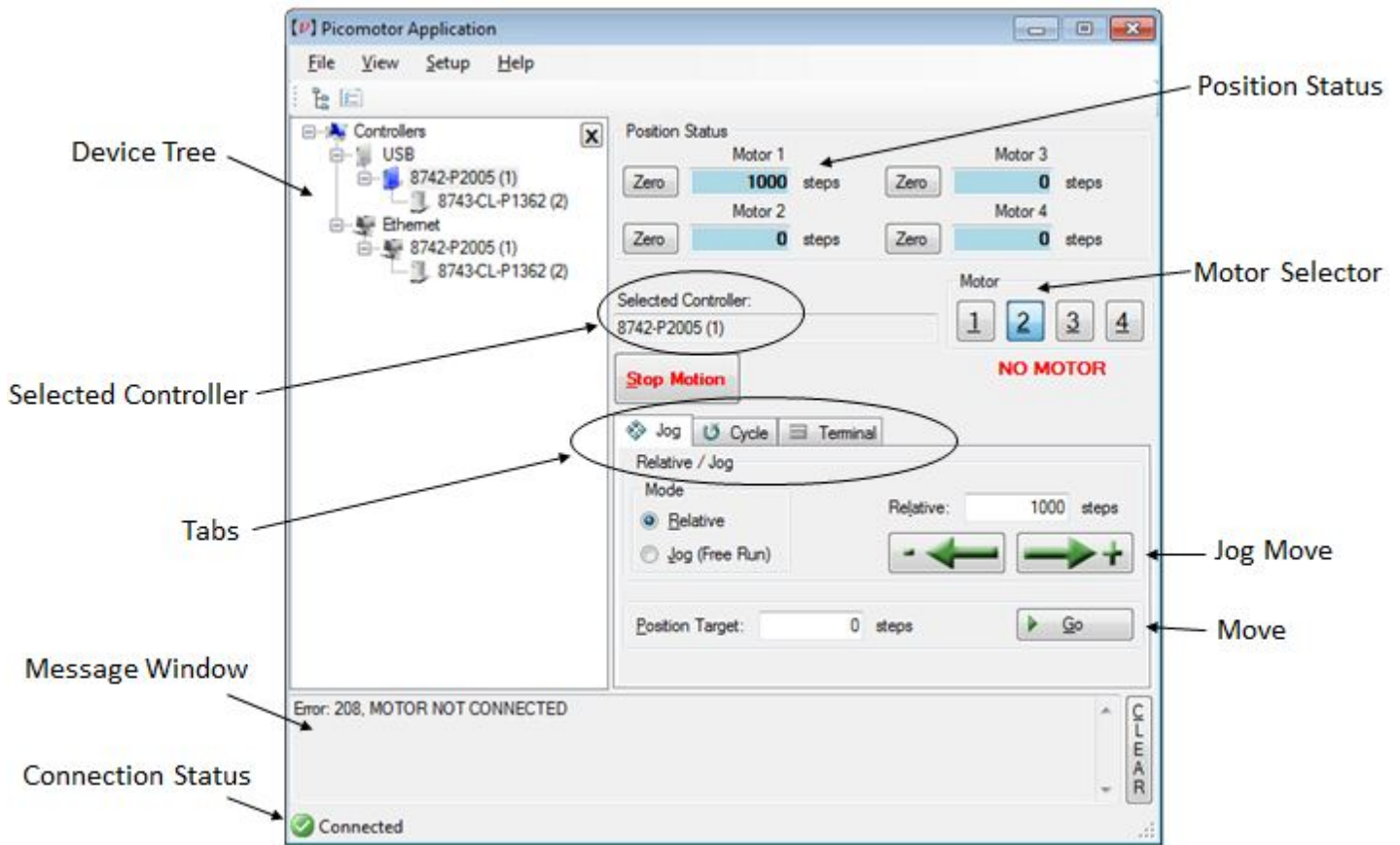

Figure 28 Jog Tab

Cycle Motion

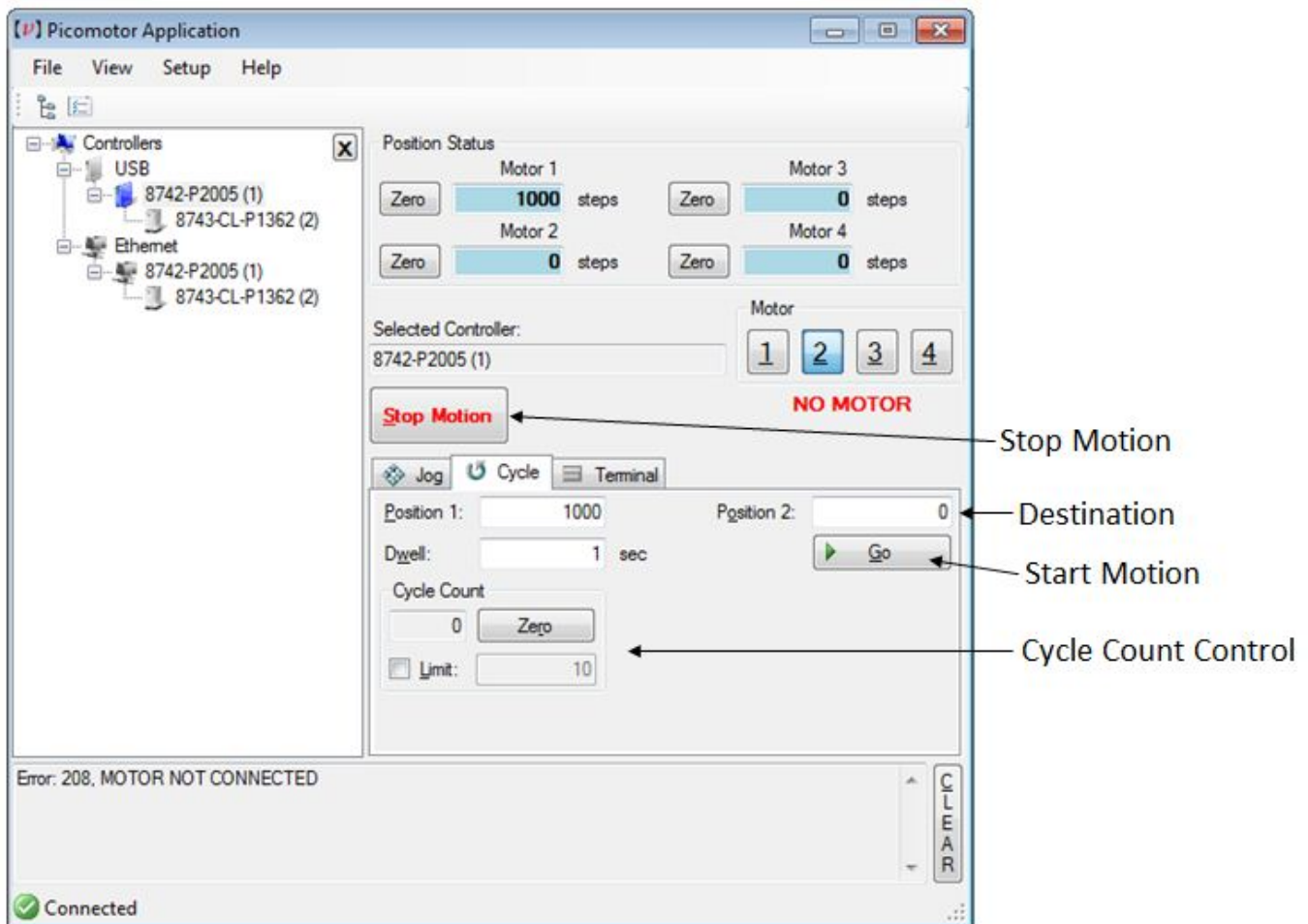

Figure 29 Cycle Tab

Command Line Terminal

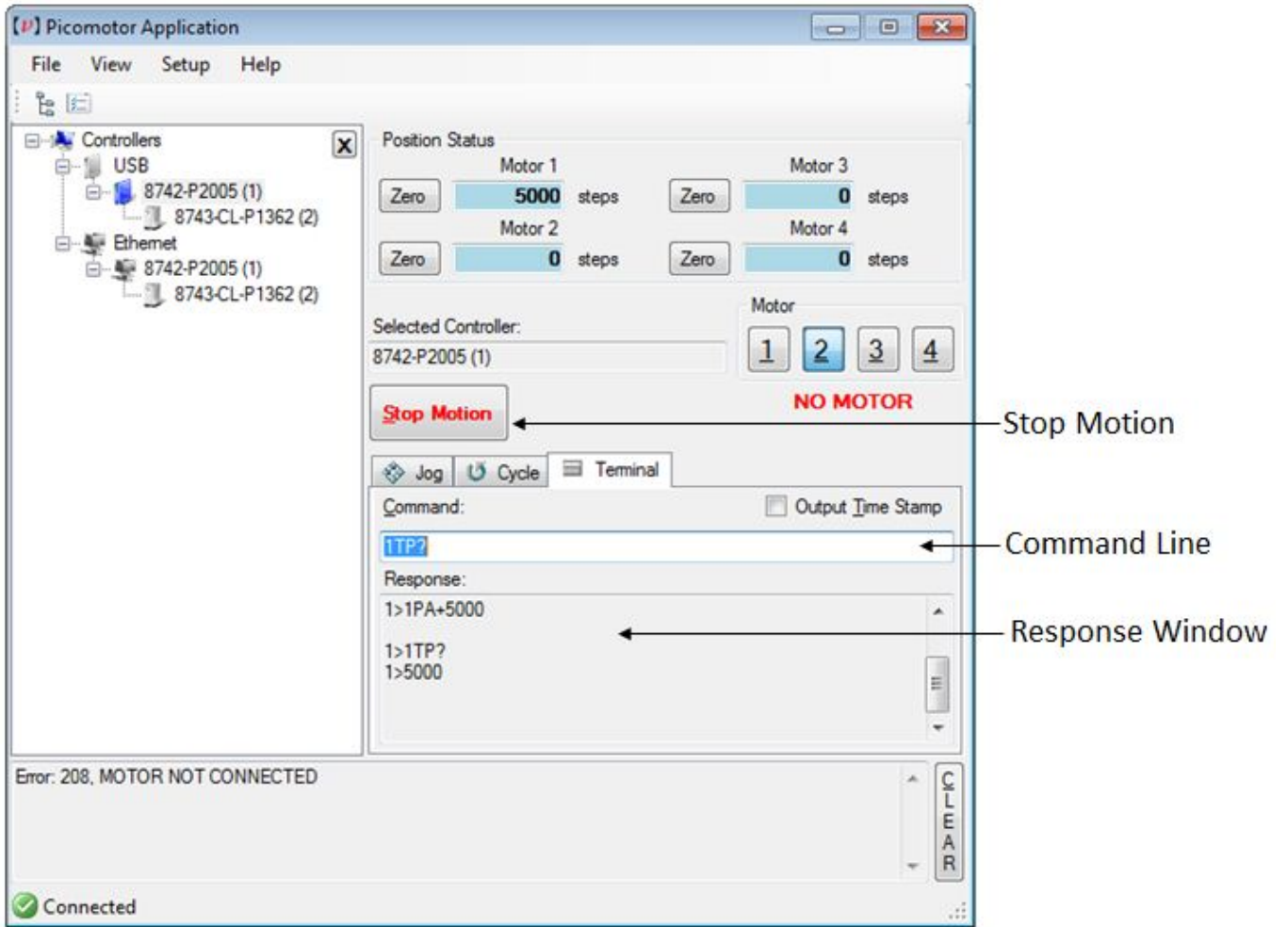

Figure 30 Terminal Tab

Controller Setup

Click Setup, Controller to select the motor type, velocity and acceleration

Select Motor Type

Velocity Box

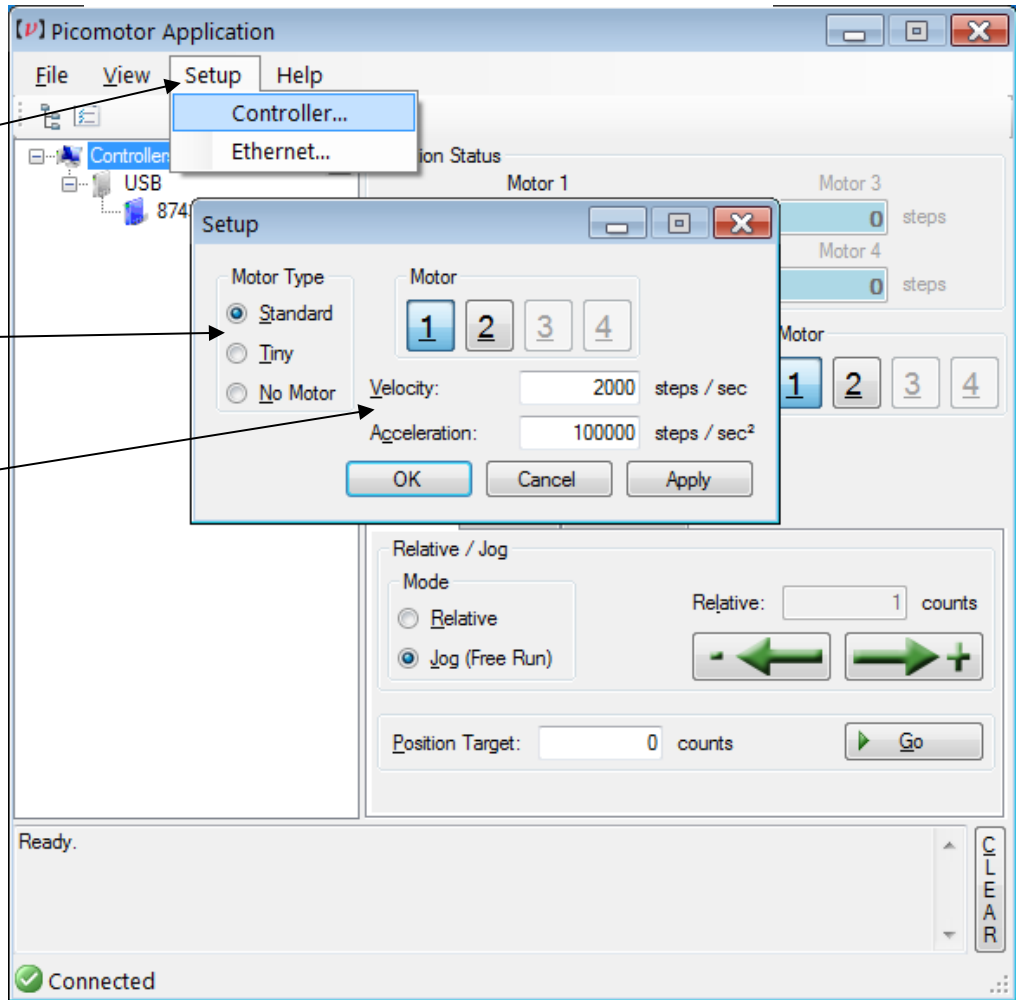

Figure 31 Controller Setup Window

Ethernet Setup

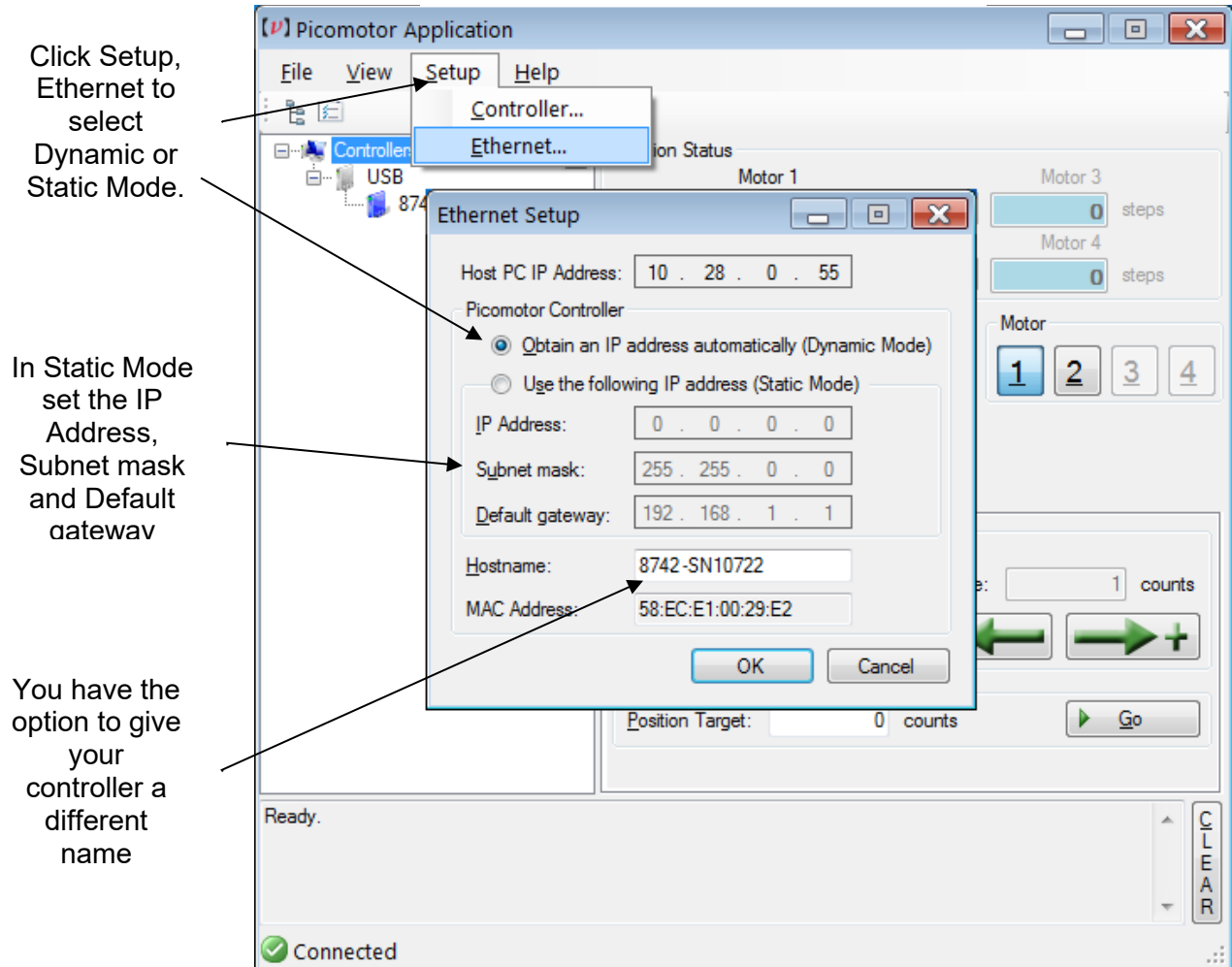

Figure 32 Ethernet Setup Window

Connection Options Setup

The Options window let's users manage:

- Auto connect options
- Auto motor checking
- Auto closed-loop enable
- Status refresh rate
- Ethernet discovery rate

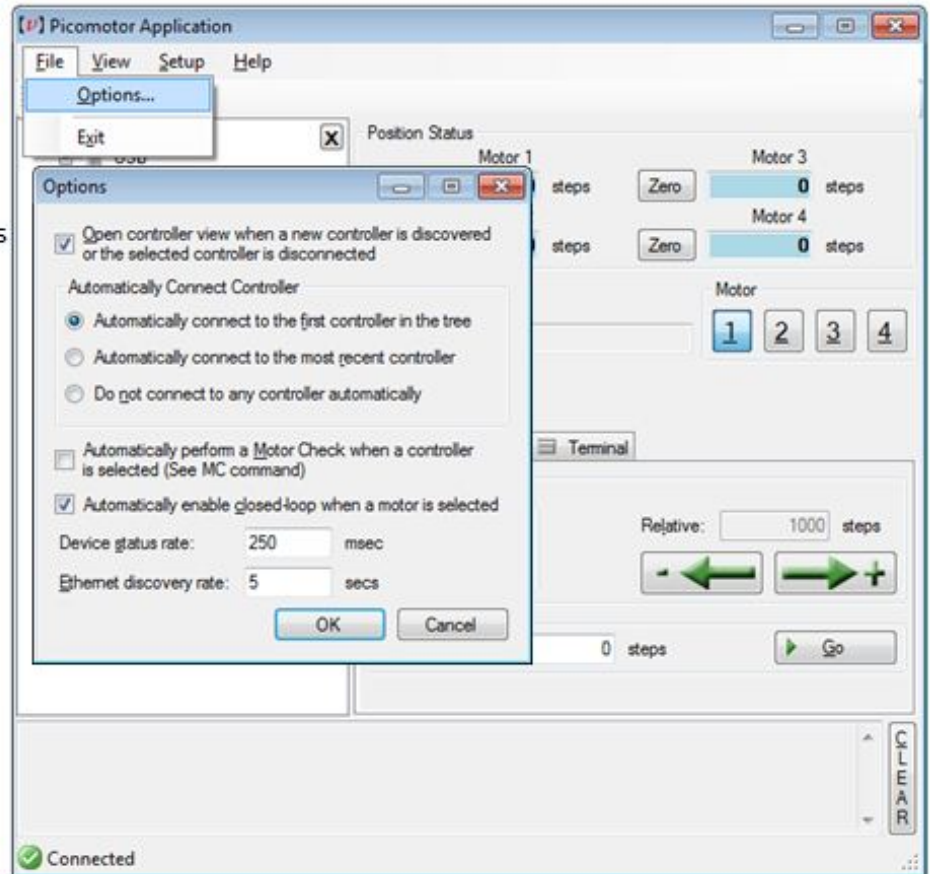

Figure 33 Options Window

USB and Ethernet Properties

The device (controller) properties window opens when

(a) Selected by a 'right-click' over the controller model and serial number info within the 'device tree' list and then,

(b) Followed by a click on the Properties option.

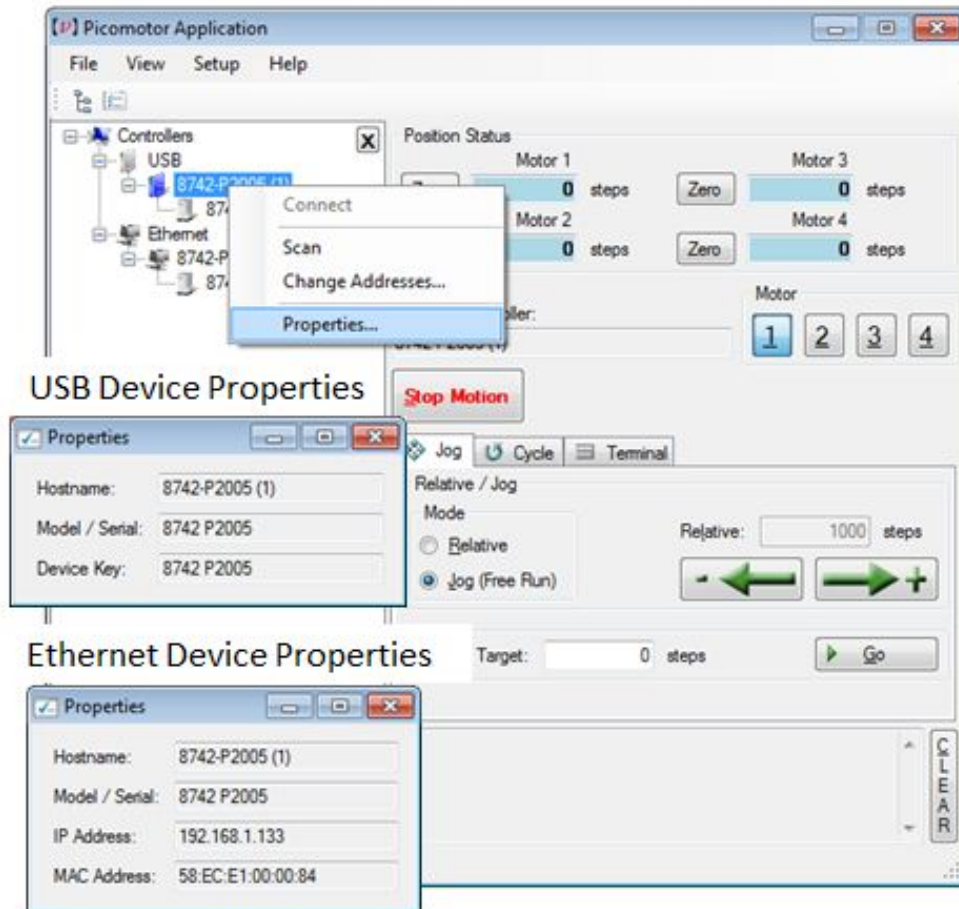

Figure 34 *Properties Window*

The Scan for controllers function begins when...

- (a) Selected by a 'right-click' over the controller model and serial number info within the 'device tree' list and then,
- (b) Followed by a click on the 'Scan' option

Initiating a Scan causes the selected controller to check for presence of any 'slave' controllers connected to its RS-485 LAN and list them.

Note: A Scan is automatically initiated whenever a controller is first 'discovered' via Ethernet or USB.

Scanning started notification

Scan RS-485 LAN

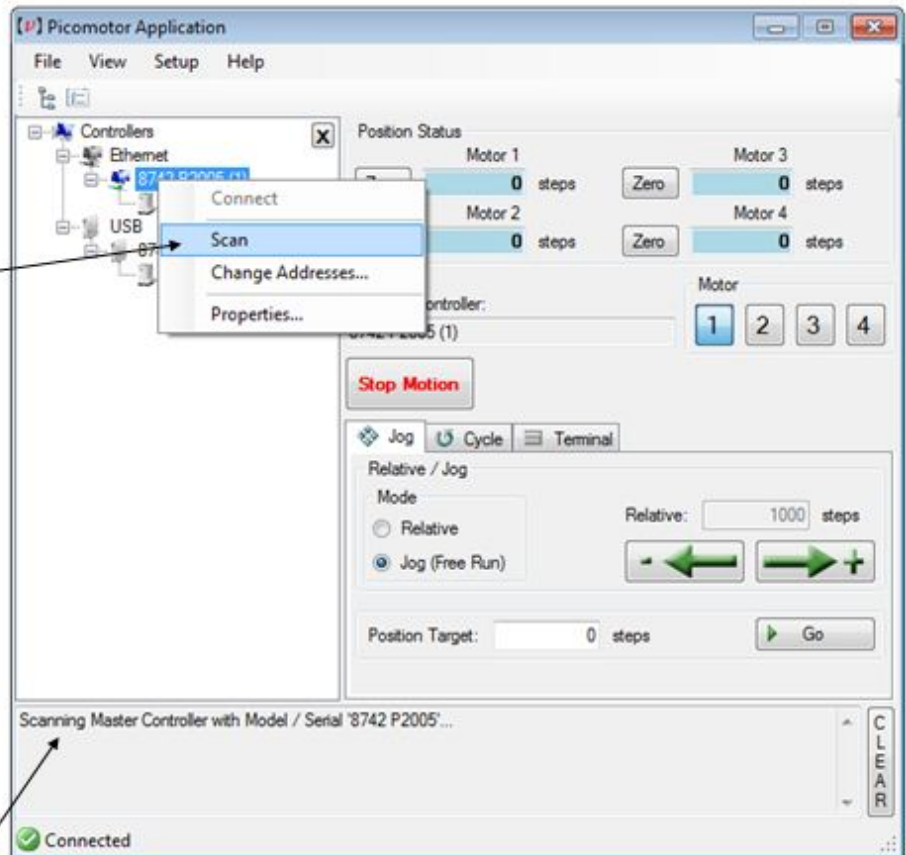

Figure 35 *Controller Scan*

Automatic Address Conflict Resolution

The Address Conflict Resolution pop-up window automatically appears whenever a duplicate 'slave' controller address is found after a Scan.

Users then have the option to:

- (a) Do nothing (ignore it)
- (b) Reassign all unit addresses to sequential order or,
- (c) Reassign only unit addresses found in conflict

Most common resolution option selected

Address conflict found

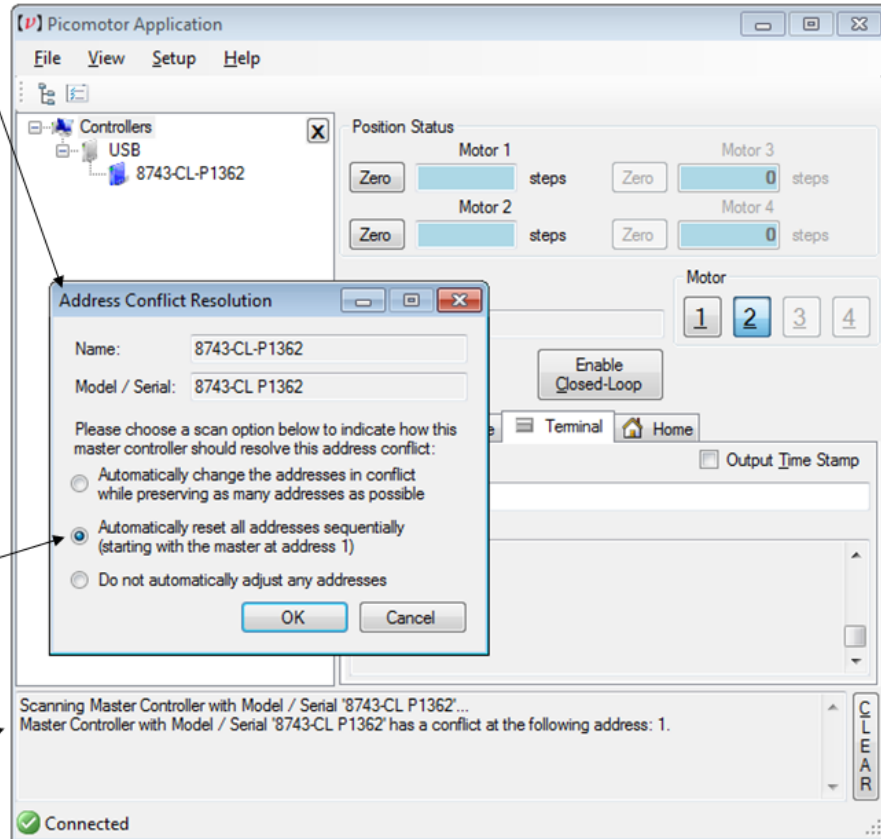

Figure 36 *Address Conflict Resolution Window*

View/Change Controller Address

The device (controller)
Change Addresses window
opens when

- (a) Selected by a 'right-click'
over the controller model
and serial number info
within the 'device tree'
list and then,
- (b) Followed by a click on the
Change Addresses option

Device Address Window

Drop-down List

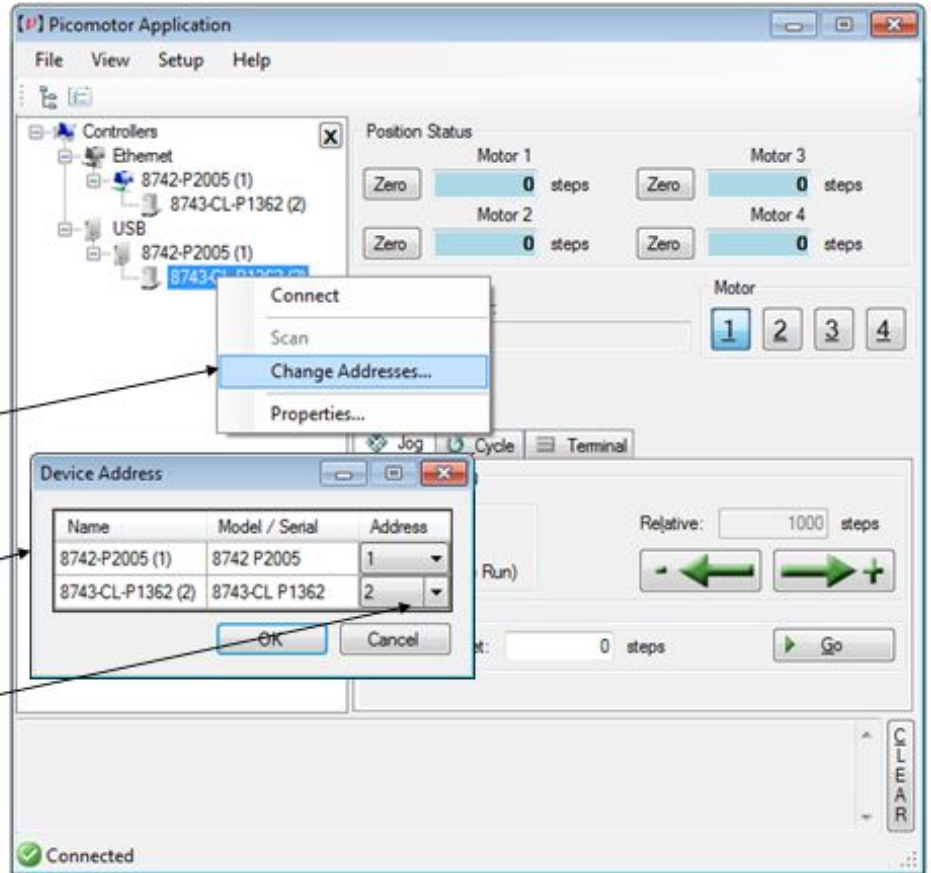

Figure 37 Device Address Window

5.6.3 Embedded Dynamic HTTP Server

It is also possible to communicate to the controller via its Ethernet interface through a computer's web browser (e.g., Safari, Chrome, Internet Explorer). Once you know the controller's IP address, which can be gotten from the Ethernet Properties view in the Windows Application (see previous page). Enter the IP address in the browser's address bar and this will take you to the controller's HTTP server page.

This advanced controller has an embedded HTTP server which generates a dynamic Web page to accept command line input and show immediate response.

Embedded Dynamic HTTP Server

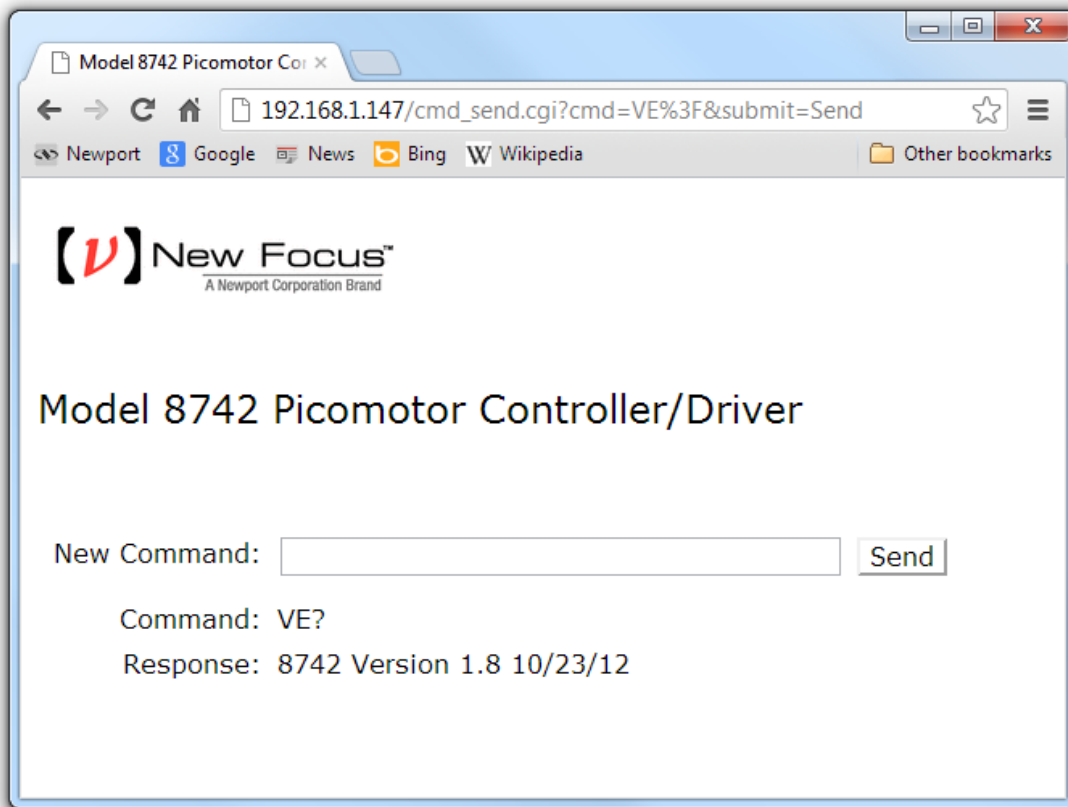

Chrome Browser (v22) running on Windows 7

Figure 38 *Internet Browser View*

5.7 LabVIEW™ and C# Programming Support

Detailed LabVIEW and C# programming instructions are discussed in a separate document named “Picomotor Samples.pdf” (Typically installed in the following folder [C:\Program Files\New Focus\Picomotor Application\Docs](#))

Additionally, sample code is found in the “Samples” folder (Typically installed in the following folder [C:\Program Files\New Focus\Picomotor Application\Samples](#))

5.7.1 Introduction

The programming samples are divided into two folders: C# and LabVIEW. These two folders contain samples that have been developed in the C# programming language and the LabVIEW programming language.

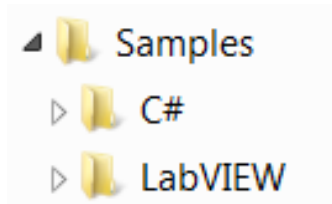

6 Remote Command Set

6.1 Command Syntax

The 8742 Controller/Driver utilizes an ASCII command set and also outputs system status in ASCII format. Commands may be either upper or lower case characters.

The diagram below illustrates the 8742 controller command syntax. As indicated in this diagram, a valid command consists of three main fields. The first field consists of a numerical parameter “xx”, the second field consists of a two letter ASCII mnemonic, and the third field consists of numerical parameter “nn”. The command is finally terminated by a carriage return. For example, 3PA10 is a valid command.

If a command does not require parameter “xx” and/or parameter “nn”, that field may be skipped by leaving a blank character (space). For example, 1DH, and VE? are valid commands.

Multiple commands can be issued on a single command line by separating the commands with a semi-colon (;). For example, “3VA1500; 3PA1000” is a valid command line. If a command line has multiple query commands, the response string from the controller will have responses to all the query commands in the command line. Each response in the response string will be separated by a semi-colon. For example, the response to “3VA?; 3AC?” command can be “2000; 30000”. In this example, the value 2000 is a response to 3VA? command, and the value 30000 is a response to 3AC? command.

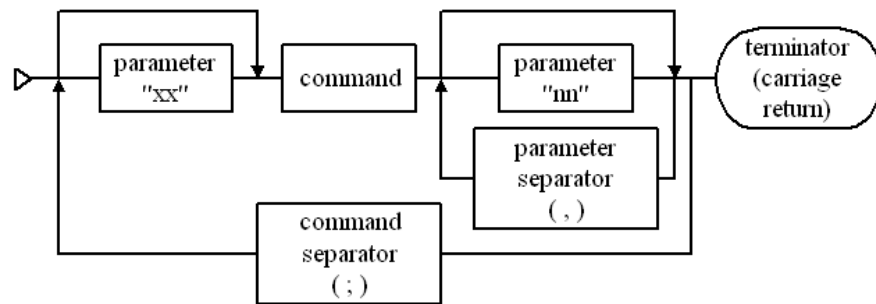

Figure 39 Command Syntax Diagram

6.1.1 RS-485 Command Syntax

The command syntax for communicating with controllers on an RS-485 network is very similar to communicating with them directly using USB/Ethernet interface with the following exceptions.

1. All the commands intended for a slave controller must have a slave controller address prefix added to the command. For example, to query the motion status of motor 2 on a slave controller with address 3, the host PC must send “3>2MD?” command to the master controller. In this command, “3>” is the slave controller address prefix. This prefix tells the master controller that the command “2MD?” is intended for slave controller with address 3.
2. When the master controller sends a response back to host PC, it too will have a slave controller address prefix. This is used to inform the host that the response came from a slave controller with that address. For example, the response received by a host PC to the above mentioned command might be “3>1”. This indicates that the motion of motor #2 in slave controller with address 3 is complete.
3. If a command does not have controller address prefix, the master controller will assume that the command is addressed it and process the same.
4. Since the master controller processes one command string at a time, semicolon (;) delimited commands cannot be sent to slave controllers.

NOTE

A controller command (or a sequence of commands) has to be terminated with a carriage return character. However, responses from the controller are always terminated by a carriage return/line feed combination. This setting may not be changed.

6.1.2 Summary of Command Syntax

COMMAND FORMAT

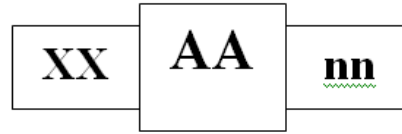

The general format of a command is a two character mnemonic (AA). Both upper and lower case are accepted. Depending on the command, it could also have optional or required preceding (xx) and/or following (nn) parameters.

BLANK SPACES

Blank spaces are allowed and ignored between parameters and commands. For the clarity of the program and memory saving considerations, use blank spaces with restraint. The following two commands are equivalent.

```
2 PA 1000  
2PA1000
```

COMMAND LINE

Commands are executed line by line. A line can consist of one or a number of commands. The controller will interpret the commands in the order they are received and execute them sequentially. This means that commands issued on the same line are executed significantly closer to each other than if they would be issued on separate lines. The maximum number of characters allowed on a command line is 64.

SEPARATOR

Commands issued on the same line must be separated by semicolons (;).

Multiple parameters issued for the same command are separated by commas (,).

TERMINATOR

Each command line must end with a line terminator, i.e., carriage return.

6.2 Command List

The controller understands many commands. The following table lists all of them in alphabetical order. It also shows whether the command can be issued while motion of any Picomotor is in progress or otherwise.

Command	Description	Command executed when motion is in progress
*IDN?	Identification string query	◆
*RCL	Recall parameters	
*RST	Reset instrument	◆
AB	Abort motion	◆
AC	Set acceleration	◆
AC?	Get acceleration	◆
DH	Define home position	
DH?	Get home position	◆
MC	Motor check	
MD?	Get motion done status	◆
MV	Move indefinitely	
MV?	Get motion direction	◆
PA	Move to a target position	
PA?	Get destination position	◆
PR	Move relative	
PR?	Get destination position	◆
QM	Set motor type	◆
QM?	Get motor type	◆
RS	Reset the controller	◆
SA	Set controller address	◆
SA?	Get controller address	◆
SC	Scan RS-485 network	◆
SC?	Get RS-485 network controller addresses	◆
SD?	Get scan status	◆
SM	Save to non-volatile memory	◆
ST	Stop motion	◆
TB?	Get error message	◆

TE?	Get error number	◆
TP?	Get position	◆
VA	Set velocity	◆
VA?	Get velocity	◆
VE?	Firmware version string query	◆
XX	Purge memory	
ZZ	Set configuration register	◆
ZZ?	Get configuration register	◆

ETHERNET RELATED COMMANDS

Command	Description	Command executed when motion is in progress
GATEWAY	Default gateway address	◆
GATEWAY?	Default gateway address query	◆
HOSTNAME	Hostname	◆
HOSTNAME?	Hostname query	◆
IPADDR	IP address	◆
IPADDR?	IP address query	◆
IPMODE	IP mode	◆
IPMODE?	IP mode query	◆
MACADDR?	MAC address query	◆
NETMASK	Network mask address	◆
NETMASK?	Network mask address query	◆

6.2.1 Description of Commands

NOTE

Many of the commands take an axis number as a parameter (xx). For such commands, the valid range of axis number is from 1 to 4.

*IDN?

Description Product identification string query.

Syntax *IDN?

Remarks This query will cause the instrument to return a unique identification string. This similar to the Version (VE) command but provides more information. In response to this command the controller replies with company name, product model name, firmware version number, firmware build date, and controller serial number. No two controllers share the same model name and serial numbers, therefore this information can be used to uniquely identify a specific controller.

Model Name	Firmware Version #	Firmware Date	Controller Serial #
⏟	⏟	⏟	⏟

New_Focus XXXX vYYY mm/dd/yy, SNZZZZ

Example *IDN? (Get product identification information)
 New_Focus 8742 v1.9 10/23/12 SN10001 (Controller replies with ID string)

See Also VE?

***RCL**

Description Recall command.

Syntax *RCL *Bin*

Remarks This command restores the controller working parameters from values saved in its non-volatile memory. It is useful when, for example, the user has been exploring and changing parameters (e.g., velocity) but then chooses to reload from previously stored, qualified settings. Note that “*RCL 0” command just restores the working parameters to factory default settings. It does not change the settings saved in EEPROM.

The parameters that can be restored are:

1. Hostname (see HOSTNAME command)
2. IP Mode (see IPMODE command)
3. IP Address (see IPADDRESS command)
4. Subnet mask address (see NETMASK command)
5. Gateway address (see GATEWAY command)
6. Configuration register (see ZZ command)
7. Motor type (see QM command)
8. Desired Velocity (see VA command)
9. Desired Acceleration (see AC command)

Argument	Value	Description
<i>Bin</i>	0	Restores factory default settings
	1	Restores last saved settings

Example *RCL1 (Restore from last saved settings)

See Also SM, XX

***RST**

Description Reset command.

Syntax *RST

Remarks This command performs a “soft” reset or reboot of the controller CPU. Upon restart the controller reloads parameters (e.g., velocity and acceleration) last saved in non-volatile memory.

Note that upon executing this command, USB and Ethernet communication will be interrupted for a few seconds while the controller re-initializes. Ethernet communication may be significantly delayed (~30 seconds) in reconnecting depending on connection mode (Peer-to-peer, static or dynamic IP mode) as the PC and controller are negotiating TCP/IP communication.

See Also RS

AB

Description Abort motion.

Syntax AB

Remarks This command is used to instantaneously stop any motion that is in progress. Motion is stopped abruptly. For stop with deceleration see ST command which uses programmable acceleration/deceleration setting.

Example 1MV+ (Move motor 1 indefinitely in positive direction)
AB (Abort /halt motion)

See Also ST

AC**Description** Acceleration set.**Syntax** xxACnn**Remarks** This command is used to set the acceleration value for an axis. The acceleration setting specified will not have any effect on a move that is already in progress. If this command is issued when an axis' motion is in progress, the controller will accept the new value but it will use it for subsequent moves only.

Argument	Value	Description
xx	1 to 4	Axis number
nn	1 to 200000	Acceleration (steps/sec ²). Default = 100000 steps/sec ²

Example 2AC150000 (set acceleration to 150,000 steps/sec²)**See Also** AC?, VA, VA?**AC?****Description** Acceleration query.**Syntax** xxAC?**Remarks** This command is used to query the acceleration value for an axis.

Argument	Value	Description
xx	1 to 4	Axis number

Response	Value	Description
Value	Integer	Acceleration setting (steps/sec ²)

Example 2AC?
150000 (get acceleration setting)
(reply; 150,000 steps/sec²)**See Also** AC, VA, VA?

DH**Description** Home position set.**Syntax** xx**DH**nn**Remarks** This command is used to define the “home” position for an axis. The home position is set to 0 if this command is issued without “nn” value. Upon receipt of this command, the controller will set the present position to the specified home position. The move to absolute position command (PA) uses the “home” position as reference point for moves.

Argument	Value	Description
<i>xx</i>	1 to 4	Axis number
<i>nn</i>	Integer	Home position (steps). Default = 0 steps. Valid values between -2147483648 and +2147483647.

Example
1DH (set motor 1 counter to 0)
2DH1000 (set motor 2 counter equal to 1000)**See Also** DH?, TP?, PA

DH?**Description** Home position query.**Syntax** xx**DH?****Remarks** This command is used to query the home position value for an axis.

Argument	Value	Description
<i>xx</i>	1 to 4	Axis number

Response	Value	Description
<i>Value</i>	Integer	Home position setting (steps)

Example
2DH? (get home position)
0 (reply; home position is 0)**See Also** DH, TP?

MC

Description Motor check command

Syntax MC

Remarks This command scans for motors connected to the controller, and sets the motor type based on its findings. If the piezo motor is found to be type 'Tiny' then velocity (VA) setting is automatically reduced to 1750 if previously set above 1750. To accomplish this task, the controller commands each axis to make a one-step move in the negative direction followed by a similar step in the positive direction. This process is repeated for all the four axes starting with the first one. If this command is issued when an axis is moving, the controller will generate "MOTION IN PROGRESS" error message.

NOTE: Motor type and velocity changes are not automatically saved to non-volatile memory. Issue the Save (SM) command after motor check to save all changes.

NOTE: Here is a command sequence which disables auto-motor type detection and sets motor 1 (for example) to type 'Standard': 1ZZ1;1QM3;1SM

Example MC (Check all motors to determine type)
SM (Save new settings to memory)

See Also *RST, VA, SM

MD?

Description Motion done status query.

Syntax xxMD?

Remarks This command is used to query the motion status for an axis.

Argument	Value	Description
xx	1 to 4	Axis number

Response	Value	Description
<i>Value</i>	0	Motion is in progress
	1	Motion is not in progress

Example 2MD? (Get motor 2 motion status)
1 (Returns value of 1 which means motor 2 is not moving)

See Also TP?

MV**Description** Indefinite move command.**Syntax** `xxMVnn`**Remarks** This command is used to move an axis indefinitely. If this command is issued when an axis' motion is in progress, the controller will ignore this command and generate "MOTION IN PROGRESS" error message.

Issue a Stop (ST) or Abort (AB) motion command to terminate motion initiated by MV

Argument	Value	Description
<i>xx</i>	1 to 4	Axis number
<i>nn</i>	+	Move desired axis in positive direction
	-	Move desired axis in negative direction

Example

1MV+ (Move motor 1 indefinitely in positive direction)
 AB (Abort /halt motion)

2MV- (Move motor 2 indefinitely in negative direction)
 2ST (Stop motion)

See Also PA, PR, ST, AB

PA

Description Target position move command.

Syntax xxPA nn

Remarks This command is used to move an axis to a desired target (absolute) position relative to the home position defined by DH command. Note that DH is automatically set to 0 after system reset or a power cycle. If this command is issued when an axis' motion is in progress, the controller will ignore this command and generate "MOTION IN PROGRESS" error message. The direction of motion and number of steps needed to complete the motion will depend on where the motor count is presently at before the command is issued.

Issue a Stop (ST) or Abort (AB) motion command to terminate motion initiated by PA

Argument	Value	Description
xx	1 to 4	Axis number
nn	Integer	Absolute position (steps). Default = 0 steps. Valid values between -2147483648 and +2147483647.

Example 1PA+200000 (Move motor 1 to target position +200000)

See Also MV, PR, DH

PA?

Description Target position query.

Syntax xxPA?

Remarks This command is used to query the target position of an axis.

Argument	Value	Description
xx	1 to 4	Axis number
Response	Value	Description
nn	Integer	Target position (steps).

Example 2PA?
200000 (Get motor 2 target position)
(Returns value of 200000 step target position)

See Also MV, PR

PR**Description** Relative move command.**Syntax** `xxPRnn`**Remarks** This command is used to move an axis by a desired relative distance. If this command is issued when an axis' motion is in progress, the controller will ignore this command and generate "MOTION IN PROGRESS" error message.

Issue a Stop (ST) or Abort (AB) motion command to terminate motion initiated by PR

Argument	Value	Description
<i>xx</i>	1 to 4	Axis number
<i>nn</i>	Integer	Relative distance (steps). Default = 0 steps. Valid values between -2147483648 and +2147483647.

Example `1PR-200000` (Move motor 1 relative negative 200000 steps)**See Also** `MV, PA`

PR?**Description** Target position query.**Syntax** `xxPR?`**Remarks** This command is used to query the target position of an axis.

Argument	Value	Description
<i>xx</i>	1 to 4	Axis number
Response	Value	Description
<i>nn</i>	Integer	Target position (steps).

Example `2PR?` (Get motor 2 target position)
`200000` (Returns value of 200000 step target position)**See Also** `MV, PA`

QM

Description Motor type set command.

Syntax xxQMnn

Remarks This command is used to manually set the motor type of an axis. Send the Motors Check (MC) command to have the controller determine what motors (if any) are connected. Note that for motor type 'Tiny', velocity should not exceed 1750 step/sec. To save the setting to non-volatile memory, issue the Save (SM) command.

Note that the controller may change this setting if auto motor detection is enabled by setting bit number 0 in the configuration register to 0 (default) with ZZ command. When auto motor detection is enabled the controller checks motor presence and type automatically during all moves and updates QM status accordingly.

Argument	Value	Description
xx	1 to 4	Axis number
nn	0	No motor connected
	1	Motor type unknown
	2	'Tiny' Motor
	3	'Standard' motor

Example 2QM3 (Set motor 2 to type 'Standard' Picomotor)
SM (Save new settings to memory)

See Also QM?, MC, ZZ, SM

QM?**Description** Motor type query.**Syntax** `xxQM?`**Remarks** This command is used to query the motor type of an axis.

It is important to note that the QM? command simply reports the present motor type setting in memory. It does not perform a check to determine whether the setting is still valid or corresponds with the motor connected at that instant.

If motors have been removed and reconnected to different controller channels or if this is the first time, connecting this system then issuing the Motor Check (MC) command is recommended. This will ensure an accurate QM? command response.

Argument	Value	Description
<i>xx</i>	1 to 4	Axis number

Response	Value	Description
<i>nn</i>	Integer	Motor type.

Example `1QM?` (Get motor 1 motor type setting)
 `0` (Return 0; no motor connected)

See Also **QM, CM, ZZ**

RS**Description** Reset command**Syntax** **RS****Remarks** This command performs a “soft” reset or reboot of the controller CPU. Upon restart the controller reloads parameters (e.g., velocity and acceleration) last saved in non-volatile memory and sets Home (DH) position to 0.

Note that upon executing this command, USB and Ethernet communication will be interrupted for a few seconds while the controller re-initializes. Ethernet communication may be significantly delayed (~30 seconds) in reconnecting depending on connection mode (Peer-to-peer, static or dynamic IP mode) as the PC and controller are negotiating TCP/IP communication.

Example `RS` (Reboot/reset controller)**See Also** ***RST**

SA

Description Controller address set.

Syntax SA nn

Remarks This command is used to set the address of a controller. This command is useful when communicating with controllers on an RS-485 network, where all controllers on the network must have unique addresses. The default controller address is 1.

Argument	Value	Description
<i>nn</i>	Integer	Controller address. Default = 1. Valid values between 1 and 31.

Example SA5 (set controller address to 5)
SM (save new address in controller's memory)

See Also SA, SC, SD?

SA?

Description Controller address query.

Syntax SA?

Remarks This command is used to query the controller's address.

Response	Value	Description
<i>Value</i>	Integer	Controller address

Example SA? (get controller's address)
5 (reply; controller address is 5)

See Also SA, SC, SD?

SC

Description Initiate scan process.

Syntax SC nn

Remarks This command is used to initiate scan of controllers on RS-485 network. When a master controller receives this command, it scans the RS-485 network for all the slave controllers connected to it.

If $nn = 0$, the master controller scans the network but does not resolve any address conflicts.

If $nn = 1$, the master controller scans the network and resolves address conflicts, if any. This option preserves the non-conflicting addresses and reassigns the conflicting addresses starting with the lowest available address. For example, during an initial scan, if the master controller determines that there are unique controllers at addresses 1,2, and 7 and more than one controller at address 23, this option will reassign only the controllers with address conflict at 23; the controllers with addresses 1,2, and 7 will remain untouched. In this case, after conflict resolution, the final controller addresses might be 1,2,3,7, and 23 if the master determines that there are two (2) controllers initially at address 23.

If $nn = 2$, the master controller reassigns the addresses of all controllers on the network in a sequential order starting with master controller set to address 1. In the example mentioned above, after reassignment of addresses, the final controller addresses will be 1,2,3,4, and 5.

Argument	Value	Description
nn	Integer	Scan option. Valid values between 0 and 2.

Example SC0 (scan the RS-485 network but do not any address conflicts)

See Also SA, SC?, SD?

SC?

Description RS-485 controller address map query.

Syntax SC?

Remarks This command is used to query the list of all controllers on an RS-485 network.

Response	Value	Description
<i>Value</i>	Integer	32-bit value. Default = 0

Bit#	Value	Description
0	0	The scan process did not find any address conflicts
0	1	The scan process found at least one address conflicts
1	0	There is no controller with address 1 on the network
1	1	There is a controller with address 1 on the network
31	0	There is no controller with address 31 on the network
31	1	There is a controller with address 31 on the network

Bits 1—31 are one-to-one mapped to controller addresses 1—31. The bit value is set to 1 only when there are no conflicts with that address.

For example, if the master controller determines that there are unique controllers at addresses 1,2, and 7 and more than one controller at address 23, this query will return 135. The binary representation of 135 is 10000111. Bit #0 = 1 implies that the scan found at least one address conflict during last scan. Bit #1,2, 7 = 1 implies that the scan found controllers with addresses 1,2, and 7 that do not conflict with any other controller.

Example SC? (get controller address map)
135 (reply; see above description)

See Also SA, SC, SD?

SD?

Description Scan done status query.

Syntax SD?

Remarks This command is used to query the scan status.

Response	Value	Description
<i>Value</i>	0	Scan is in progress
	1	Scan is not in progress

Example SD? (Get scan status)
1 (Returns value of 1 which means scan is not in progress)

See Also SC, SC?

SM

Description Save settings command

Syntax SM

Remarks This command saves the controller settings in its non-volatile memory. The controller restores or reloads these settings to working registers automatically after system reset or it reboots. The Purge (XX) command is used to clear non-volatile memory and restore to factory settings. Note that the SM saves parameters for all motors.

The SM command saves the following settings:

1. Hostname (see HOSTNAME command)
2. IP Mode (see IPMODE command)
3. IP Address (see IPADDRESS command)
4. Subnet mask address (see NETMASK command)
5. Gateway address (see GATEWAY command)
6. Configuration register (see ZZ command)
7. Motor type (see QM command)
8. Desired Velocity (see VA command)
9. Desired Acceleration (see AC command)

Example 1VA 1750; 2VA1500 (See motor 1 & 2 velocity)
SM (Save settings to non-volatile memory)

See Also XX, *RCL

ST

Description Stop motion command

Syntax xxST

Remarks This command is used to stop the motion of an axis. The controller uses acceleration specified using AC command to stop motion. If no axis number is specified, the controller stops the axis that is currently moving. Use Abort (AB) command to abruptly stop motion without deceleration.

Argument	Value	Description
xx	1 to 4	Axis number

Example

1MV+	(Move motor 1 indefinitely in positive direction)
1ST	(Stop motion)
ST	(Stop motion on any motor that is moving)

See Also AB, AC

TB?**Description** Error message query**Syntax** TB?**Remarks** This command is used to read the error code, and the associated message.

The error code is one numerical value up to three(3) digits long. (see Appendix for complete listing) In general, non-axis specific errors numbers range from 0-99. Axis-1 specific errors range from 100-199, Axis-2 errors range from 200-299 and so on. The message is a description of the error associated with it. All arguments are separated by commas.

Note: Errors are maintained in a FIFO buffer ten(10) elements deep. When an error is read using TB or TE, the controller returns the last error that occurred and the error buffer is cleared by one(1) element. This means that an error can be read only once, with either command.

Response	Value	Description
<i>nn, ssss</i>	integer, string	Error code, Error message

Example

TB?	(Get error status)
108, MOTOR NOT CONNECTED	(Returns motor 1 not connected error message)
TB?	(Get error status)
0, NO ERROR DETECTED	(Returns no error found message)

See Also TE

TE?

Description Error code query

Syntax TE?

Remarks This command is used to read the error code. The error code is one numerical value up to three(3) digits long. (see Appendix for complete listing) In general, non-axis specific errors numbers range from 0-99. Axis-1 specific errors range from 100-199, Axis-2 errors range from 200-299 and so on.

Note: Errors are maintained in a FIFO buffer ten(10) elements deep. When an error is read using TB or TE, the controller returns the last error that occurred and the error buffer is cleared by one(1) element. This means that an error can be read only once, with either command.

Response	Value	Description
<i>nn</i>	integer	Error code

Example

TE?	(Get error status)
108	(Returns 108; motor 1 not connected)
TE?	(Get error status)
0	(Returns 0; no error detected)

See Also TB

TP?

Description Actual Position query.

Syntax xxTP?

Remarks This command is used to query the actual position of an axis. The actual position represents the internal number of steps made by the controller relative to its position when controller was powered ON or a system reset occurred or Home (DH) command was received.
Note that the real or physical position of the actuator/motor may differ as a function of mechanical precision and inherent open-loop positioning inaccuracies.

Argument	Value	Description
xx	1 to 4	Axis number

Response	Value	Description
nn	Integer	Present position (steps)

Example 1TP? (Get motor 1 position status)
10500 (Returns 10500; motor 1 position)

See Also PA, PR, MV, DH

VA**Description** Velocity set**Syntax** xxVAnn

Remarks This command is used to set the velocity value for an axis. The velocity setting specified will not have any effect on a move that is already in progress. If this command is issued when an axis' motion is in progress, the controller will accept the new value but it will use it for subsequent moves only. The maximum velocity for a 'Standard' Picomotor is 2000 steps/sec, while the same for a 'Tiny' Picomotor is 1750 steps/sec.

Argument	Value	Description
xx	1 to 4	Axis number
nn	1 to 2000	Velocity (steps/sec). Default = 2000 steps/sec

Example 1VA1750 (Set motor 1 velocity to 1750 steps/sec)

See Also VA?, AC, AC?

VA?**Description** Velocity query.**Syntax** xxVA?

Remarks This command is used to query the velocity value for an axis.

Argument	Value	Description
xx	1 to 4	Axis number

Response	Value	Description
Value	Integer	Velocity setting (steps/sec)

Example 1VA? (Get motor 1 velocity)
1750 (Returns 1750; motor 1 velocity)

See Also VA, AC, AC?

VE?**Description** Controller firmware version query.**Syntax** VE?**Remarks** This command is used to query the controller model number and firmware version. To query product serial number information see *IDN command.

Response	Value	Description
ss	String	8742 Version 1.9 11/01/12 <i>version = 1.; release date = 11/01/12</i>

Example VE (Get model name and firmware version)
8742 Version 1.9 11/01/12 (Replies with model and firmware info string)

See Also *IDN?

XX**Description** Purge all user settings in controller memory.**Syntax** XX**Remarks** This command is used to purge all user settings in the controller non-volatile memory and restore them to factory default settings.

The following parameters are affected by this command:

1. Hostname (see HOSTNAME command)
2. IP Mode (see IPMODE command)
3. IP Address (see IPADDRESS command)
4. Subnet mask address (see NETMASK command)
5. Gateway address (see GATEWAY command)
6. Configuration register (see ZZ command)
7. Motor type (see QM command)
8. Desired Velocity (see VA command)
9. Desired Acceleration (see AC command)

Example XX (Purge all user settings)**See Also** *RCL

ZZ**Description** Configuration register set**Syntax** *ZZnn***Remarks** This command is used to configure the default behavior of some of the controller's features. It is typically followed with an SM (Save to Memory) command.

Bit#	Value	Description
*0	0	Perform auto motor detection. Check and set motor type automatically when commanded to move.
0	1	Do not perform auto motor detection on move
*1	0	Do not scan for motors connected to controllers upon reboot (Performs 'MC' command upon power-up, reset or reboot)
1	1	Scan for motors connected to controller upon power-up or reset

Example: *ZZ 1; SM* (Disable automatic motor check and save to memory)
ZZ 3; SM (Disable motor check on move, check motors on system reset)

See Also *RCL, MC**ZZ?****Description** Configuration register query.**Syntax** *ZZ?***Remarks** This command is used to query the configuration register setting.

Response	Value	Description
<i>nn</i>	Integer	Configuration register.

Example: *ZZ ?* (Get configuration register settings)
 1 (Returns 1; bit-0=1 & bit-1=0; means auto motor detection on move is disabled)

See Also *ZZ*

GATEWAY

Description Default gateway address set.

Syntax `GATEWAY address`

Remarks This command is used to set the Ethernet default gateway address. In order for this setting to take effect, please set the controller to Static IP mode (IPMODE), save (SM) this parameter in the controller's non-volatile memory, and reset (RS) the controller.

NOTE: Send this command via USB interface as Ethernet communication may become unstable during Ethernet settings configuration. While connected via USB, use the Picomotor application software to send commands (Go to 'Terminal' tab).

Argument	Value	Description
<i>address</i>	nn1.nn2.nn3.nn4	Gateway address. (Example. 192.168.10.101) <i>nn1,nn2,nn3,nn4 can be numbers between 0 and 255.</i>

Example:

IPMODE 0	(Set to static IP mode)
GATEWAY 192.168.10.101	(Set gateway address)
NETMASK 255.255.255.0	(Set Netmask address)
IPADDR 192.168.1.101	(Set IP address)
SM; RS	(Save and reset system)

See Also IPMODE, SM, RS

GATEWAY?

Description Default gateway address query.

Syntax `GATEWAY?`

Remarks This command is used to query the default gateway address

Response	Value	Description
<i>address</i>	nn1.nn2.nn3.nn4	Gateway address. (Example. 192.168.10.101) <i>nn1,nn2,nn3,nn4 can be numbers between 0 and 255.</i>

Example:

GATEWAY?	(Get gateway address)
192.168.10.101	(Returns 192.168.10.101; gateway address)

See Also IPMODE, GATEWAY

HOSTNAME

Description Hostname set.

Syntax **HOSTNAME** *name*

Remarks This command is used to set the controller's hostname. A hostname is a label or nickname assigned to a device connected to a computer network and is used to identify the device in various forms of communication. This feature enables users to assign the controller a more easily identifiable name, perhaps linked to its actual function in an application (e.g., TIPTILT, MIRROR-2). This command is more common with Ethernet but can also be used with USB communication.

NOTE: Send this command via USB interface as Ethernet communication may become unstable during Ethernet settings configuration. While connected via USB, use the Picomotor application software to send commands (Go to 'Terminal' tab).

The default hostname for the controller is 8742-*serialnum*, where *serialnum* is the controller's serial number. The hostname can have a maximum of 15 alphanumeric characters and hyphen ("-") character. The first character in the hostname cannot be a hyphen ("-"). Issue Save (SM) and Reset (RS) commands to controller for this parameter to take affect.

Argument	Value	Description
<i>name</i>	string	Hostname

Example: HOSTNAME TIPTILT-1;SM;RS (Set hostname, save, and reset system)
 HOSTNAME? (Get hostname)
 TIPTILT-1 (Returns "TIPTILT-1"; hostname)

See Also IPMODE, SM, RS

HOSTNAME?

Description Hostname query.

Syntax **HOSTNAME?**

Remarks This command is used to query the controller's hostname

Response	Value	Description
<i>name</i>	string	Hostname

Example: HOSTNAME? (Get hostname)
 TIPTILT-1 (Returns "TIPTILT"; hostname)

See Also IPMODE

IPADDR

Description IP address set.

Syntax **IPADDR** *address*

Remarks This command is used to set the controller's internet protocol (IP) address. An IP address consists of four numbers, each of which contains one to three digits, with a single dot (.) separating each number or set of digits. Each of the four numbers can range from 0 to 255.

In order for this setting to take effect, please set the controller to Static IP mode, save (SM) this parameter in the controller's non-volatile memory, and reset (RS) the controller to take affect.

NOTE: Send this command via USB interface as Ethernet communication may become unstable during Ethernet settings configuration. While connected via USB, use the Picomotor application software to send commands (Go to 'Terminal' tab).

Argument	Value	Description
<i>address</i>	nn1.nn2.nn3.nn4	IP address. (Example. 192.168.1.101) <i>nn1,nn2,nn3,nn4 can be numbers between 0 and 255.</i>

Example:

IPMODE 0	(Set to static IP mode)
GATEWAY 192.168.10.101	(Set gateway address)
NETMASK 255.255.255.0	(Set Netmask address)
IPADDR 192.168.1.101	(Set IP address)
SM; RS	(Save and reset system)

See Also **IPMODE, SM, RS**

IPADDR?

Description IP address query.

Syntax **IPADDR?**

Remarks This command is used to query the controller's IP address

Response	Value	Description
<i>address</i>	nn1.nn2.nn3.nn4	IP address. (Example. 192.168.1.101) <i>nn1,nn2,nn3,nn4 can be numbers between 0 and 255.</i>

Example:

IPADDR 192.168.1.101;SM;RS	(Set IP address, save, and reset system)
IPADDR?	(Get IP address)
192.168.1.101	(Returns 192.168.1.101; IP address)

See Also **IPMODE, IPADDR, SM, RS**

IPMODE

Description IP mode set command.

Syntax IPMODEnn

Remarks This command is used to set the controller's IP mode. In order for this setting to take effect, please save this setting in the controller's non-volatile memory and reset the controller.

As the name implies, Static IP addresses are the same every time you connect. Dynamic IP addresses may change each time you connect to the Internet. Dynamic IP addresses are the normal customer access method used by most ISPs or Service Providers and this is the default IP mode for this product

Having a static IP address for your dedicated server means an IP address will be assigned to your server (controller) only once and that IP address will belong to your dedicated server forever. A static IP address will be given out to your dedicated server so that every time it logs in it will be using the same IP address for all of its sessions.

NOTE: Send this command via USB interface as Ethernet communication may become unstable during Ethernet settings configuration. While connected via USB, use the Picomotor application software to send commands (Go to 'Terminal' tab).

Argument	Value	Description
<i>nn</i>	0	Static IP
	1	DHCP (default)

Example:

IPMODE 0	(Set to static IP mode)
GATEWAY 192.168.10.101	(Set gateway address)
NETMASK 255.255.255.0	(Set Netmask address)
IPADDR 192.168.1.101	(Set IP address)
SM; RS	(Save and reset system)

See Also IPMODE?, IPADDR, SM, RS

IPMODE?

Description IP mode query.

Syntax IPMODE?

Remarks This command is used to query the controller's IP mode.

Response	Value	Description
<i>nn</i>	Integer	IP mode

Example: IPMODE ? (Get IP mode)
1 (Returns 1; in DHCP mode)

See Also IPMODE

MACADDR?

Description MAC address query.

Syntax MACADDR?

Remarks This command is used to query the controller's MAC address.

A Media Access Control address (MAC address) is a unique identifier assigned to network interfaces for communications on the physical network segment. MAC addresses are used for numerous network technologies and most IEEE 802 network technologies, including Ethernet. Logically, MAC addresses are used in the Media Access Control protocol sub-layer of the OSI reference model.

Response	Value	Description
<i>address</i>	<i>nn1,nn2</i>	MAC address. (Example.5827809, 20) <i>nn1</i> is Newport's unique identifier (0x58ECE1); <i>nn2</i> is controller's unique identifier

Example: MACADDR ? (Get MAC address)
5827809, 20 (Returns 5827809, 20; MAC address)

See Also HOSTNAME

NETMASK

Description Network mask address set.

Syntax **NETMASK** *address*

Remarks This command is used to set the controller's network mask address. In order for this setting to take effect, please set the controller to Static IP mode, save this parameter in the controller's non-volatile memory, and reset the controller.

A netmask is a 32-bit mask used to divide an IP address into subnets and specify the networks available hosts. In a netmask, two bits are always automatically assigned. For example, in 255.255.225.0, "0" is the assigned network address; and in 255.255.255.255, "255" is the assigned broadcast address. The 0 and 255 are always assigned and cannot be used.

NOTE: Send this command via USB interface as Ethernet communication may become unstable during Ethernet settings configuration. While connected via USB, use the Picomotor application software to send commands (Go to 'Terminal' tab).

Argument	Value	Description
<i>address</i>	nn1.nn2.nn3.nn4	Network mask address. (Example. 192.168.255.0) <i>nn1,nn2,nn3,nn4 can be numbers between 0 and 255.</i>

Example:

IPMODE 0	(Set to static IP mode)
GATEWAY 192.168.10.101	(Set gateway address)
NETMASK 255.255.255.0	(Set Netmask address)
IPADDR 192.168.1.101	(Set IP address)
SM; RS	(Save and reset system)

See Also NETMASK?, IPMODE, IPADDR, SM, RS

NETMASK?

Description Network mask address query.

Syntax **NETMASK?**

Remarks This command is used to query the controller's network mask address.

Response	Value	Description
<i>address</i>	nn1.nn2.nn3.nn4	Network mask address. (Example. 192.168.255.0) <i>nn1,nn2,nn3,nn4 can be numbers between 0 and 255.</i>

Example:

NETMASK ?	(Get Netmask)
255.255.255.0	(Returns 255.255.255.0; Netmask)

See Also NETMASK

7 Appendix

7.1 Non Axis-Specific Error Messages

0, NO ERROR DETECTED

There are no error messages in the error buffer

3, OVER TEMPERATURE SHUTDOWN

The temperature inside the controller has exceeded 85°C. Under this condition, the controller automatically stops any motion that is in progress and changes the status LED color to solid RED. When the temperature goes below 75°C, the controller changes the status LED color to solid GREEN. Motion related commands can once again be issued in this state.

6, COMMAND DOES NOT EXIST

The command sent to the controller is invalid. Please check the command syntax.

7, PARAMETER OUT OF RANGE

The parameter sent along with a command is out of range.

9, AXIS NUMBER OUT OF RANGE

The axis number specified is out of range.

10, EEPROM WRITE FAILED

Unable to save the controller's settings in its non-volatile memory.

11, EEPROM READ FAILED

Unable to restore the controller's settings from its non-volatile memory.

37, AXIS NUMBER MISSING

The command sent to the controller requires an axis number prefix. Please check the command syntax.

38, COMMAND PARAMETER MISSING

The command sent to the controller requires a valid parameter. Please check the command syntax.

46, RS-485 ETX FAULT DETECTED

A slave controller can generate this error message if the command received by it is incomplete; the number of bytes transmitted by a master controller do not match the number of bytes received by the slave controller.

A master controller can generate this error message if the response received by it is incomplete; the number of bytes transmitted by a slave controller do not match the number of bytes received by the master controller.

NOTE: Check for (a) improper RS-485 cable connection, (b) controller address conflict, or (c) prohibited multiple master configuration.

47, RS-485 CRC FAULT DETECTED

A slave controller can generate this cyclical redundancy check (CRC) error message if a checksum verification of the command received by it does not match the checksum computed by master controller.

A master controller can generate this cyclical redundancy check (CRC) error message if a checksum verification of the response received by it does not match the checksum computed by slave controller.

NOTE: Check for (a) improper RS-485 cable connection, (b) controller address conflict, or (c) prohibited multiple master configuration.

48, CONTROLLER NUMBER OUT OF RANGE

The controller number prefix is out of range.

49, SCAN IN PROGRESS

This error message is generated if “SC” or “SC?” commands are received by a controller while a scan is already in progress.

7.2 Axis-Specific Error Messages

Where (“x” = 1 to 4)

x00, MOTOR TYPE NOT DEFINED

A motion command has been issued to the controller before specifying a motor type. Enable auto motor detection by setting bit# 0 in configuration register to 0 (refer ZZ command) or set valid motor type (refer QM command).

x01, PARAMETER OUT OF RANGE

The parameter sent along with a command is out of range.

x08, MOTOR NOT CONNECTED

The controller has detected that there is no motor connected to the axis that is either being commanded to move or is already in motion.

x10, MAXIMUM VELOCITY EXCEEDED

The velocity parameter specified exceeds the maximum velocity rating for the connected motor.

x11, MAXIMUM ACCELERATION EXCEEDED

The acceleration parameter specified exceeds the maximum acceleration rating for the connected motor.

x14, MOTION IN PROGRESS

A new move is commanded while an axis is already moving.

8 Maintenance and Service



WARNING

There are no user serviceable parts inside the Model 8742 Controller/Driver. Work performed by persons not authorized by New Focus will void the warranty.

8.1 Enclosure Cleaning



WARNING

Before cleaning the enclosure of the 8742 Controller/Driver, the power cord must be disconnected from the wall socket and from the unit.

The source enclosure should only be cleaned with a mild soapy water solution applied to a damp lint-free cloth. Do not use an acetone or alcohol solution; this will damage the finish of the enclosure.

8.2 Technical Support

Information and advice about the operation of any New Focus product is available from our technical support engineers. For quickest response, ask for “Technical Support” and know the model and serial number for your product.

Hours: 8:00–5:00 PST, Monday through Friday (excluding holidays).

Toll Free: 1-866-NUFOCUS (1-866-683-6287)

(from the USA & Canada only)

Phone: (408) 284-6808

Support is also available by fax and email:

Fax: (408) 980-4300

Email: techsupport@newfocus.com

We typically respond to faxes and email within one business day.

8.3 Service

Your 8742 Controller/Driver has been designed to provide years of trouble-free operation. Virtually no maintenance is required except for ensuring that the unit is not damaged, contaminated, or used in an unsafe manner.

8.4 Obtaining Service

The 8742 Controller/Driver contains no user serviceable parts. To obtain information regarding factory service, contact New Focus or your New Focus representative. Please have the following information available:

1. Instrument model number (on the rear panel).
2. Instrument serial number (on rear panel or bottom of enclosure).
3. Description of the problem.

If the instrument is to be returned to New Focus, you will be given a Return Number, which you should reference in your shipping documents. Please fill out a copy of the service form, located on the following page, and have the information ready when contacting New Focus. Return the completed service form with the instrument.

8.5 Warranty

New Focus, a division of Newport Corp, guarantees its products to be free of defects for one year from the date of shipment. This is in lieu of all other guarantees, expressed or implied, and does not cover incidental or consequential loss.

8.6 Service Form

New Focus U.S.A.
Office: 408-919-1500
FAX: 408-980-6083

Name _____ Return Authorization # _____
(Please obtain RA# prior to return of item)

Company _____
(Please obtain RA # prior to return of item)

Address _____ Date _____

Country _____ Phone Number _____

P.O. Number _____ FAX Number _____

Item(s) Being Returned:

Model # _____ Serial # _____

Description _____

Reason for return of goods (please list any specific problems):
